

**OMRON**

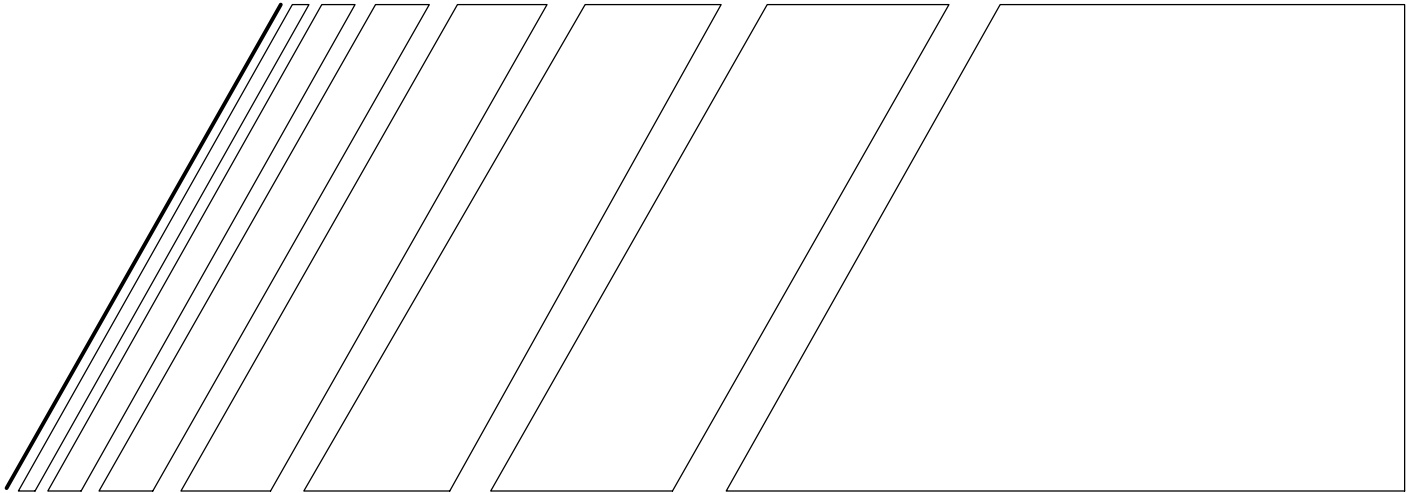

# **USER'S MANUAL**

**SYSDRIVE 3G3FV** SERIES

**High-function General-purpose Inverter**

# Table of Contents

## Chapter 1. Introduction . . . . . 1-1

|     |                        |     |
|-----|------------------------|-----|
| 1-1 | Function . . . . .     | 1-2 |
| 1-2 | Nomenclature . . . . . | 1-8 |

## Chapter 2. Installation . . . . . 2-1

|       |  |      |
|-------|--|------|
| 2-1   | Mounting . . . . .                                     | 2-2  |
| 2-1-1 | Dimensions . . . . .                                   | 2-2  |
| 2-1-2 | Installation Conditions . . . . .                      | 2-8  |
| 2-2   | Wiring . . . . .                                       | 2-10 |
| 2-2-1 | Removing and Mounting the Front Cover . . . . .        | 2-11 |
| 2-2-2 | Terminals . . . . .                                    | 2-13 |
| 2-2-3 | Standard Connection Diagram . . . . .                  | 2-17 |
| 2-2-4 | Wiring Around the Main Circuit . . . . .               | 2-21 |
| 2-2-5 | Wiring Control Circuit Terminals . . . . .             | 2-37 |
| 2-2-6 | Installing and Wiring PG Speed Control Cards . . . . . | 2-38 |

## Chapter 3. Preparing for Operation . . . . . 3-1

|     |                                      |      |
|-----|--------------------------------------|------|
| 3-1 | Using the Digital Operator . . . . . | 3-2  |
| 3-2 | Modes . . . . .                      | 3-3  |
| 3-3 | Operation Mode . . . . .             | 3-10 |
| 3-4 | Initialize Mode . . . . .            | 3-18 |
| 3-5 | Program Mode . . . . .               | 3-25 |
| 3-6 | Auto-tuning Mode . . . . .           | 3-28 |
| 3-7 | Modified Constants Mode . . . . .    | 3-30 |

## Chapter 4. Trial Operation . . . . . 4-1

|       |                                       |      |
|-------|---------------------------------------|------|
| 4-1   | Procedure . . . . .                   | 4-3  |
| 4-2   | Operation Example . . . . .           | 4-5  |
| 4-2-1 | Power Connection . . . . .            | 4-5  |
| 4-2-2 | Checking the Display Status . . . . . | 4-5  |
| 4-2-3 | Initializing Parameters . . . . .     | 4-6  |
| 4-2-4 | Setting Input Voltage . . . . .       | 4-6  |
| 4-2-5 | Auto-tuning . . . . .                 | 4-8  |
| 4-2-6 | No-load Operation . . . . .           | 4-10 |
| 4-2-7 | Actual Load Operation . . . . .       | 4-11 |

## Chapter 5. Basic Operation . . . . . 5-1

|       |   |      |
|-------|---|------|
| 5-1   | Common Settings . . . . .   | 5-2  |
| 5-1-1 | Setting the Access Level and Control Mode . . . . .                   | 5-2  |
| 5-1-2 | Frequency Reference Settings from Control Circuit Terminals . . . . . | 5-4  |
| 5-1-3 | Frequency Reference Settings from Digital Operator . . . . .          | 5-8  |
| 5-1-4 | Run Source and Responsiveness Settings . . . . .                      | 5-10 |
| 5-1-5 | Acceleration/Deceleration Time Settings . . . . .                     | 5-11 |
| 5-1-6 | Disabling Reverse Operation (b1-04) . . . . .                         | 5-12 |
| 5-1-7 | Selecting the Stopping Method (b1-03) . . . . .                       | 5-13 |
| 5-1-8 | Multi-function Input Settings (H1-01 through H1-06) . . . . .         | 5-14 |
| 5-2   | Open-loop Vector Control . . . . .                                    | 5-19 |
| 5-2-1 | Auto-tuning Procedure . . . . .                                       | 5-19 |
| 5-2-2 | Auto-tuning Faults . . . . .  | 5-20 |

# Table of Contents

|       |   |      |
|-------|---|------|
| 5-3   | V/f Control                                 | 5-22 |
| 5-3-1 | Setting the Motor Constants                 | 5-22 |
| 5-3-2 | V/f Pattern Selection (E1-03)               | 5-23 |
| 5-4   | Flux Vector Control                         | 5-28 |
| 5-4-1 | PG Speed Control Card Settings              | 5-28 |
| 5-4-2 | Setting the Zero-speed Operation Parameters | 5-31 |
| 5-4-3 | Auto-tuning                                 | 5-33 |
| 5-4-4 | Speed Loop (ASR) Structure                  | 5-36 |
| 5-4-5 | Adjusting Speed Control Loop (ASR) Gain     | 5-38 |
| 5-5   | V/f Control with PG                         | 5-41 |
| 5-5-1 | Setting the Motor Constants                 | 5-41 |
| 5-5-2 | V/f Pattern Selection (E1-03)               | 5-42 |
| 5-5-3 | PG Speed Control Card Settings              | 5-43 |
| 5-5-4 | Speed Loop (ASR) Structure                  | 5-46 |
| 5-5-5 | Adjusting Speed Control Loop (ASR) Gain     | 5-47 |

## **Chapter 6. Advanced Operation** . . . . . **6-1**

|       |   |      |
|-------|---|------|
| 6-1   | Open-loop Vector Control                          | 6-2  |
| 6-1-1 | Summary of Open-loop Vector Control Functions     | 6-2  |
| 6-1-2 | Torque Limit Function                             | 6-3  |
| 6-1-3 | Adjusting Speed Feedback                          | 6-5  |
| 6-1-4 | Setting/Adjusting Motor Constants                 | 6-6  |
| 6-2   | Normal V/f Control                                | 6-9  |
| 6-2-1 | Summary of V/f Control Functions                  | 6-9  |
| 6-2-2 | Energy-saving Control Function                    | 6-10 |
| 6-2-3 | Hunting-prevention Function                       | 6-11 |
| 6-2-4 | Setting Motor Constants                           | 6-12 |
| 6-3   | Flux Vector Control                               | 6-13 |
| 6-3-1 | Summary of Flux Vector Control Functions          | 6-13 |
| 6-3-2 | Droop Control Function                            | 6-14 |
| 6-3-3 | Zero-servo Function (Position-lock)               | 6-15 |
| 6-3-4 | Torque Control                                    | 6-16 |
| 6-3-5 | Speed/Torque Control Switching Function           | 6-23 |
| 6-3-6 | Torque Limit Function                             | 6-24 |
| 6-3-7 | Setting/Adjusting Motor Constants                 | 6-27 |
| 6-4   | V/f Control With PG Feedback                      | 6-31 |
| 6-4-1 | Summary of V/f Control With PG Feedback Functions | 6-31 |
| 6-4-2 | Energy-saving Control Function                    | 6-32 |
| 6-4-3 | Hunting-prevention Function                       | 6-33 |
| 6-4-4 | Setting Motor Constants                           | 6-34 |
| 6-5   | Common Functions                                  | 6-35 |
| 6-5-1 | Summary of Common Control Functions               | 6-35 |
| 6-5-2 | Application Parameters (b)                        | 6-36 |
| 6-5-3 | Tuning Parameters (C)                             | 6-47 |
| 6-5-4 | Reference Parameters (d)                          | 6-52 |
| 6-5-5 | Option Parameters (F)                             | 6-54 |
| 6-5-6 | External Terminal Functions: H                    | 6-58 |
| 6-5-7 | Protective Functions: L                           | 6-77 |
| 6-5-8 | Operator Parameters: o                            | 6-90 |

# Table of Contents

---

## **Chapter 7. Parameter Lists . . . . . 7-1**

|       |  |      |
|-------|--|------|
| 7-1   | Initialize Mode Parameters . . . . .     | 7-3  |
| 7-2   | Program Mode Parameter List . . . . .    | 7-5  |
| 7-2-1 | Application Group: b . . . . .           | 7-5  |
| 7-2-2 | Tuning Parameters . . . . .              | 7-12 |
| 7-2-3 | Reference Parameters List . . . . .      | 7-19 |
| 7-2-4 | Motor Constant Parameter Lists . . . . . | 7-22 |
| 7-2-5 | Options Parameter Lists . . . . .        | 7-27 |
| 7-2-6 | Terminal Parameter Lists . . . . .       | 7-32 |
| 7-2-7 | Protection Parameter Lists . . . . .     | 7-39 |
| 7-2-8 | Operator Parameter Lists . . . . .       | 7-46 |

## **Chapter 8. Maintenance Operations . . . . . 8-1**

|       |   |      |
|-------|---|------|
| 8-1   | Protective and Diagnostic Functions . . . . . | 8-2  |
| 8-1-1 | Fault Detection . . . . .                     | 8-2  |
| 8-1-2 | Minor Fault Detection . . . . .               | 8-7  |
| 8-1-3 | Operation Errors . . . . .                    | 8-9  |
| 8-2   | Troubleshooting . . . . .                     | 8-11 |
| 8-3   | Maintenance and Inspection . . . . .          | 8-18 |

## **Chapter 9. Specifications . . . . . 9-1**

|     |                                   |     |
|-----|-----------------------------------|-----|
| 9-1 | Inverter Specifications . . . . . | 9-2 |
| 9-2 | Option Specifications . . . . .   | 9-7 |

## **Chapter 10. Appendix . . . . . 10-1**

|      |   |      |
|------|---|------|
| 10-1 | Notes on Using the Inverter for a Motor . . . . . | 10-2 |
| 10-2 | List of Standard Models . . . . .                 | 10-5 |

## **Index . . . . . I-1**

## **Revision History . . . . . R-1**

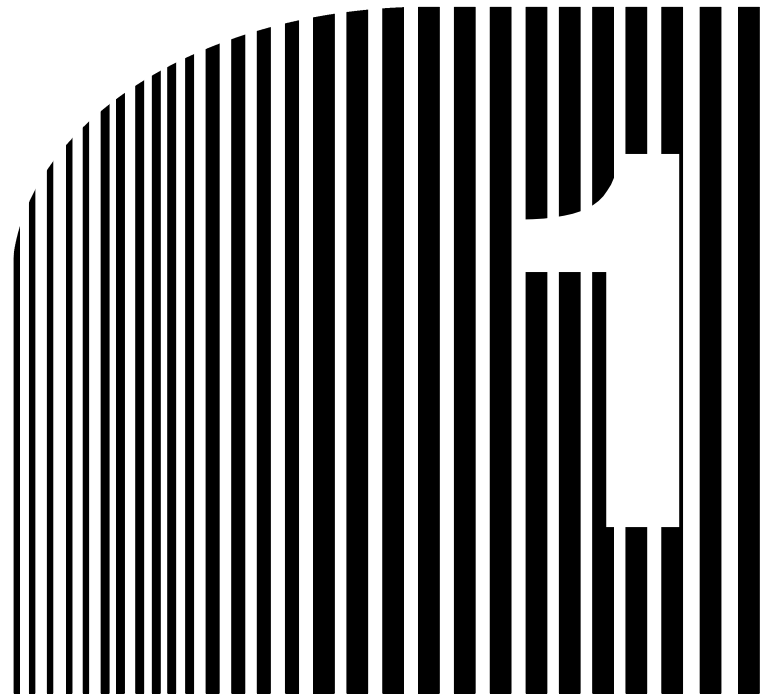

# Chapter 1

## • Introduction •

1-1 Function

1-2 Nomenclature

**1-1 Function**

---

---

---

The general-purpose SYSDRIVE 3G3FV Inverter provides full current vector control based on advanced control logic. An auto-tuning function allows for easy vector control. The Digital Operator's display area features a 2-line by 16-character liquid crystal display. The parameter settings and monitor items can be understood at a glance, providing an interactive feel during operation.

---

---

## ■ SYSDRIVE 3G3FV Inverter Models

- The following 200- and 400-V class 3G3FV Inverter models are available.
- A total of 21 types of Inverters are available for maximum applicable motor capacities of 0.4 to 300 kW.

| Voltage class            | Protective structure | Maximum applied motor capacity | Model         |
|--------------------------|----------------------|--------------------------------|---------------|
| 200-V class<br>(3-phase) | NEMA1 type           | 0.4 kW                         | 3G3FV-A2004   |
|                          |                      | 0.75 kW                        | 3G3FV-A2007   |
|                          |                      | 1.5 kW                         | 3G3FV-A2015   |
|                          |                      | 2.2 kW                         | 3G3FV-A2022   |
|                          |                      | 3.7 kW                         | 3G3FV-A2037   |
|                          |                      | 5.5 kW                         | 3G3FV-A2055   |
|                          |                      | 7.5 kW                         | 3G3FV-A2075   |
|                          |                      | 11 kW                          | 3G3FV-A2110   |
|                          |                      | 15 kW                          | 3G3FV-A2150   |
|                          | Open chassis type    | 18.5 kW                        | 3G3FV-B2185   |
|                          |                      | 22 kW                          | 3G3FV-B2220   |
|                          |                      | 30 kW                          | 3G3FV-B2300   |
|                          |                      | 37 kW                          | 3G3FV-B2370   |
|                          |                      | 45 kW                          | 3G3FV-B2450   |
|                          |                      | 55 kW                          | 3G3FV-B2550   |
|                          |                      | 75 kW                          | 3G3FV-B2750-E |
|                          |                      | 400-V class<br>(3-phase)       | NEMA1 type    |
| 0.75 kW                  | 3G3FV-A4007          |                                |               |
| 1.5 kW                   | 3G3FV-A4015          |                                |               |
| 2.2 kW                   | 3G3FV-A4022          |                                |               |
| 3.7 kW                   | 3G3FV-A4037          |                                |               |
| 5.5 kW                   | 3G3FV-A4055          |                                |               |
| 7.5 kW                   | 3G3FV-A4075          |                                |               |
| 11 kW                    | 3G3FV-A4110          |                                |               |
| 15 kW                    | 3G3FV-A4150          |                                |               |
| Open chassis type        | 18.5 kW              |                                | 3G3FV-B4185   |
|                          | 22 kW                |                                | 3G3FV-B4220   |
|                          | 30 kW                |                                | 3G3FV-B4300   |
|                          | 37 kW                |                                | 3G3FV-B4370   |
|                          | 45 kW                |                                | 3G3FV-B4450   |
|                          | 55 kW                |                                | 3G3FV-B4550   |
|                          | 75 kW                |                                | 3G3FV-B4750-E |
|                          | 110 kW               |                                | 3G3FV-B411K-E |
|                          | 160 kW               |                                | 3G3FV-B416K-E |
|                          | 185 kW               |                                | 3G3FV-B418K-E |
| 220 kW                   | 3G3FV-B422K-E        |                                |               |
| 300 kW                   | 3G3FV-B430K-E        |                                |               |

## ■ Selection of Modes for Vector Control and V/f Control

- The 3G3FV has the following four control modes.
  - Open-loop vector control (without PG\*) [Factory default]
  - Flux vector control (with PG)
  - V/f control (without PG)
  - V/f control (with PG)
- \*PG stands for “pulse generator” (encoder).
- Vector control is a method for removing interferences with magnetic flux and torque, and controlling torque according to commands. Current vector control independently controls magnetic flux current and torque current by simultaneously controlling the motor’s primary current and its phases. This allows smooth rotation and high torque, along with accurate speed and torque control, at very low speeds.
- Vector control can be replaced from the conventional V/f control system. If the motor constant required for vector control is unknown, the motor constant can be set automatically with the auto-tuning function.
- The respective control modes are effective for the following applications:
  - Open-loop vector control (without PG): General variable speed drive
  - Flux vector control (with PG): Simple servo-drive, high-precision speed control, torque control
  - V/f control (without PG): Conventional Inverter control mode. Used for multiple drives.
  - V/f control (with PG): Simple speed feedback control
- The control characteristics for each mode are shown in the following table.

|                         | Vector control |              | V/f control  |         |
|-------------------------|----------------|--------------|--------------|---------|
|                         | Without PG     | With PG      | Without PG   | With PG |
| Speed control range     | 1:100          | 1:1,000      | 1:40         | 1:40    |
| Speed control precision | ±0.2%          | ±0.02%       | ±2 to 3%     | ±0.03%  |
| Starting drive          | 150% at 1 Hz   | 150% at 0 Hz | 150% at 3 Hz |         |

## ■ Auto-tuning Function

- This function is valid with vector control.
- The motor constant is set automatically just by entering the motor’s rating plate value. This feature allows flux vector control to operate accurately with virtually any normal AC induction motor regardless of the supplier.

## ■ Torque Control

- This function is valid with flux vector control (with PG).
- Torque is controlled by taking multi-function analog input signals as torque commands.
- Switching is possible between torque control and speed control.

## ■ V/f Pattern Settings

- This function is valid for V/f control.



- Select a V/f pattern according to the application from among the 15 preset V/f patterns.
- Custom V/f pattern can be set.

## ■ Frequency References

- The following five types of frequency references can be used to control the output frequency of the Inverter.
  - Numeric input from the Digital Operator
  - Voltage input within a range from 0 to 10 V
  - Voltage input within a range from 0 to  $\pm 10$  V (With minus voltage, rotation is in the opposite direction of the run command.)
  - Current input within a range from 4 to 20 mA
  - Input by Optional Card

The Inverter can be set to use any of the above types by designating it with parameters.

- A maximum of eight frequency references can be registered with the Inverter. With remote multi-step reference input, the Inverter can be in multi-step speed operation with a maximum of eight speed steps.

## ■ PID Control

- The Inverter has a PID control function, thus performing follow-up control with ease.
- Follow-up control is a control method in which the Inverter varies the output frequency to match the feedback value from the sensor with the set target value.
- Follow-up control can be applied to a variety of control operations, depending on the contents detected by the sensor.
- PID control is available for the following applications.
  - Speed control: With a speed sensor, such as a tacho-generator, the Inverter regulates the rotation speed of the motor regardless of the load of the motor or synchronizes the rotation speed of the motor with that of another motor.
  - Pressure control: With a pressure sensor, the Inverter performs constant pressure control.
  - Flow-rate control: By sensing the flow rate of a fluid, the Inverter performs precise flow-rate control.
  - Temperature control: With a temperature sensor, the Inverter performs temperature control by fan speed.

## ■ Zero-servo Control

- This function is valid with vector control (with PG).
- Even at a motor speed of zero (0 Hz), a torque of 150% of the motor's rated torque can be generated and the average servomotor holding power (stopping power) can be obtained.

## ■ Speed Control By Feedback

- This function is valid with PG.
- An optional PG Speed Control Card be used to enable feedback control for speeds, thereby improving speed control accuracy.

## ■ Dwell Function

- By holding the output frequency for a constant time during acceleration and deceleration, acceleration and deceleration can be performed without stepping out even when driving a motor with a large start-up load.

## ■ Low Noise (0.4- to 160-kW Models)

- The output transistor of the Inverter is an IGBT (insulated gate bipolar transistor). Using a sine-wave PWM method with a high-frequency carrier, the motor does not generate metallic noise.

## ■ Monitor Function

- The following items can be monitored with the Digital Operator.

Frequency reference, output frequency, output current, motor speed, output voltage reference, main-circuit DC voltage, output power, torque reference, status of input terminals, status of output terminals, operating status, total operating time, software number, speed deviation value, PID feedback value, fault status, fault history, etc.

- All types of data can be monitored even with multi-function analog output.

## ■ Bilingual Digital Operator

- Either English and Japanese can be selected.
- The Digital Operator area utilizes a 16-character x 2-line liquid crystal display.

## ■ Harmonic Countermeasures (0.4- to 160-kW Models)

- DC reactors (optional) can be connected to 0.4- to 15-kW models.
- Models of 18.5 to 160 kW have a built-in DC reactor.

## ■ Parameter Hierarchy and Three Types of Access Levels

- The 3G3FV has a number of parameters for carrying out the various functions. These parameters are classified into hierarchical levels to make them easier to use. The levels are as follows, from top to bottom: Mode — Group — Function — Parameter.

| Level name | Contents  |
|------------|---|
| Mode       | Classified according to operation<br>Operation mode: For operating the Inverter. (All kinds of monitoring are possible.)<br>Initialize mode: For selecting the language displayed at the Digital Operator, setting access levels, and initializing.<br>Program mode: For setting parameters for operation.<br>Auto-tuning mode: For automatic calculation or setting motor constants. (Only under the vector control mode.)<br>Modified constants mode: For setting or referencing parameters changes after shipping. |
| Group      | Classified by application.  |
| Function   | Classified by function.   |
| Parameter  | Individual parameter settings.  |

- The 3G3FV allows the following three kinds of access levels to be set in order to further simplify parameter setting. (An access level is a range of parameters that can be set or referenced.)
  - Quick-start: Sets/reads parameters required for trial operation. [Factory setting]
  - Basic: Sets/reads parameters that are commonly used.
  - Advanced: Sets/reads all the parameters that can be used.
- In general, press the Enter Key to move from an upper to a lower level. This varies somewhat, however, according to the access level, as shown in the following diagram. For the Quick-start access level, which has few parameters that can be set, pressing the Enter Key jumps directly to the Parameter level; whereas for the Advanced access level, which has many, pressing the Enter Key first leads to the Group level.

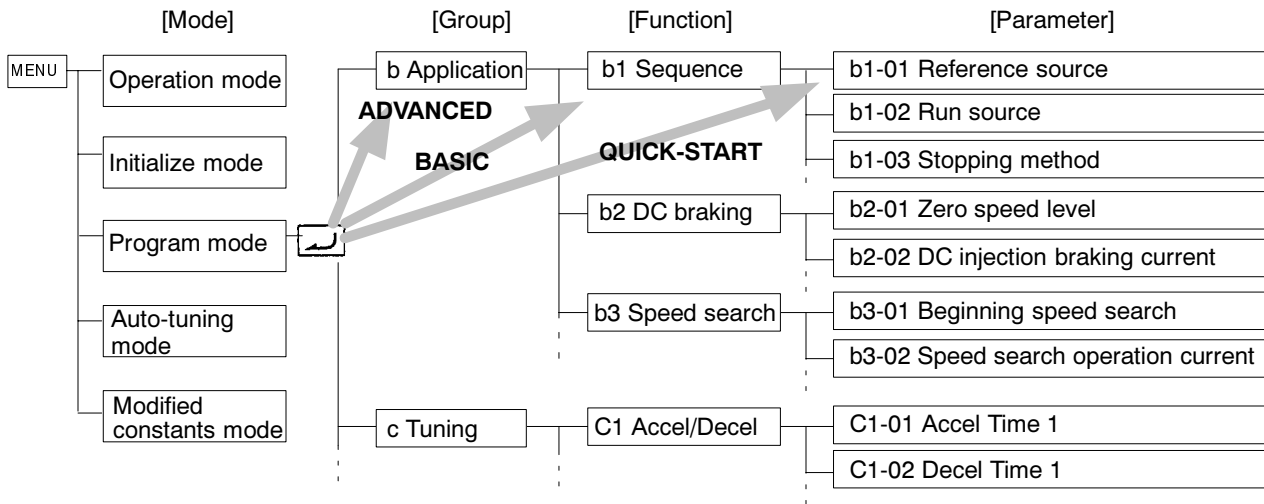

1-2 Nomenclature

■ Panel

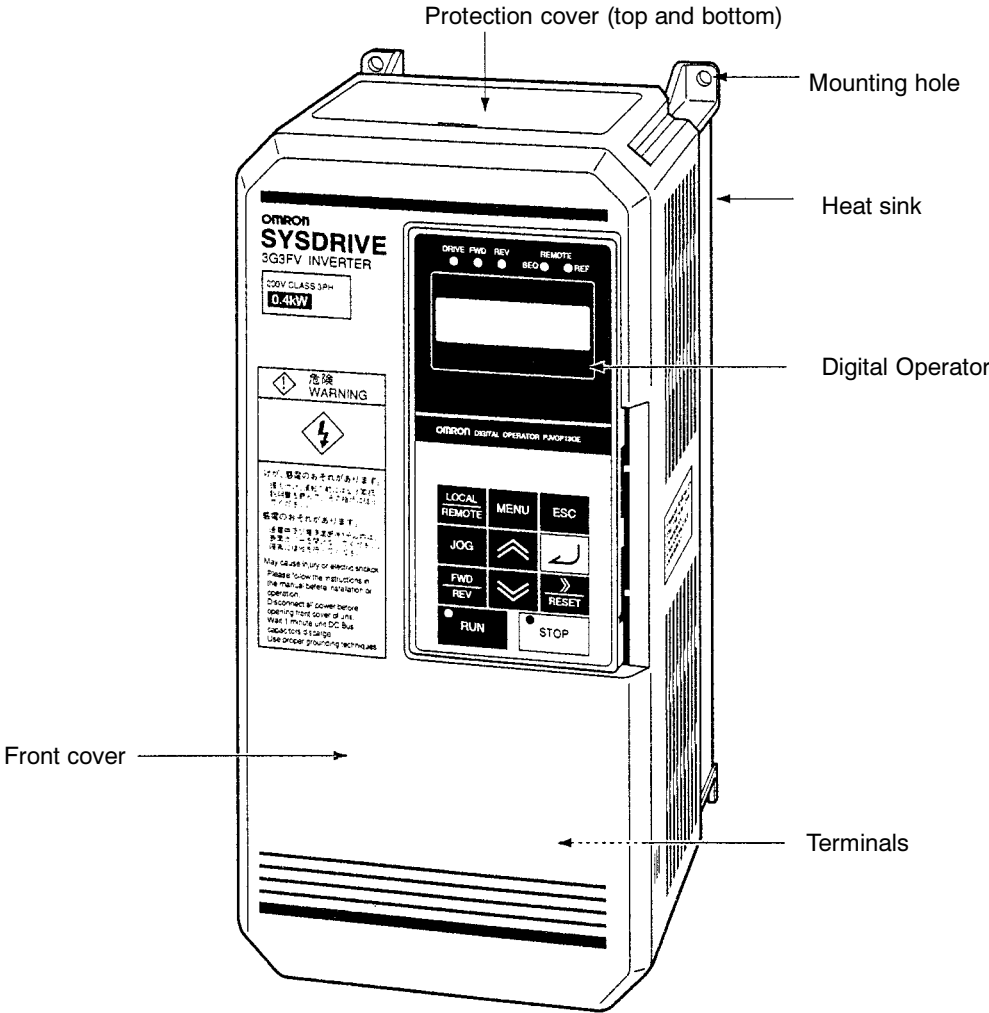

• Terminals (with Front Cover Removed)

Example: 200-V Class Inverter with 0.4-kW Output

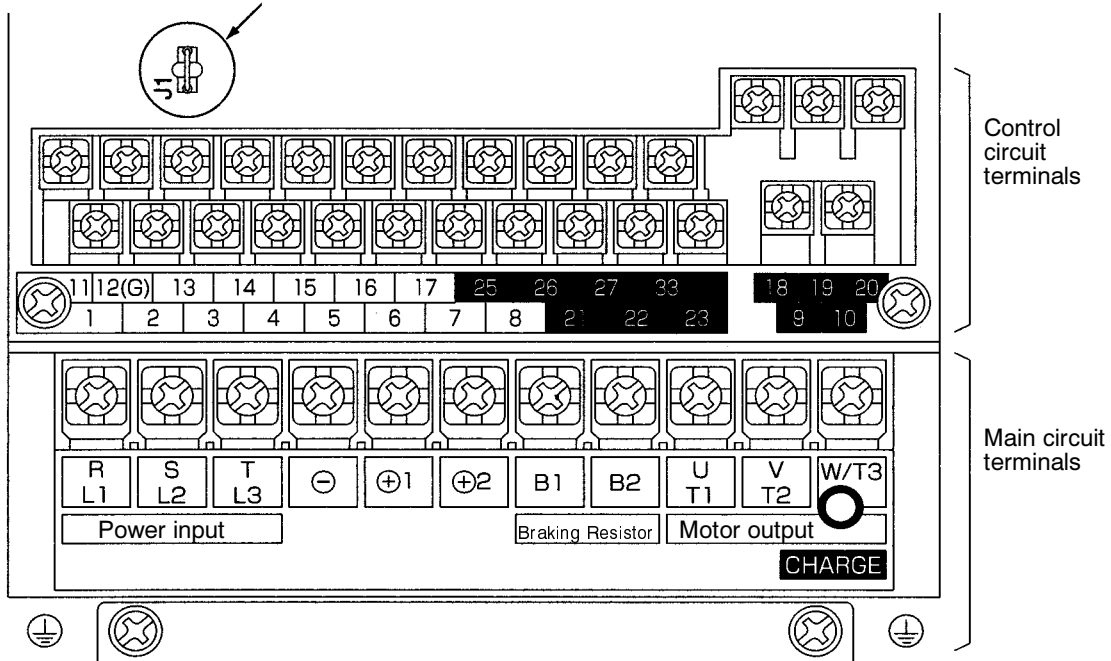

■ Digital Operator

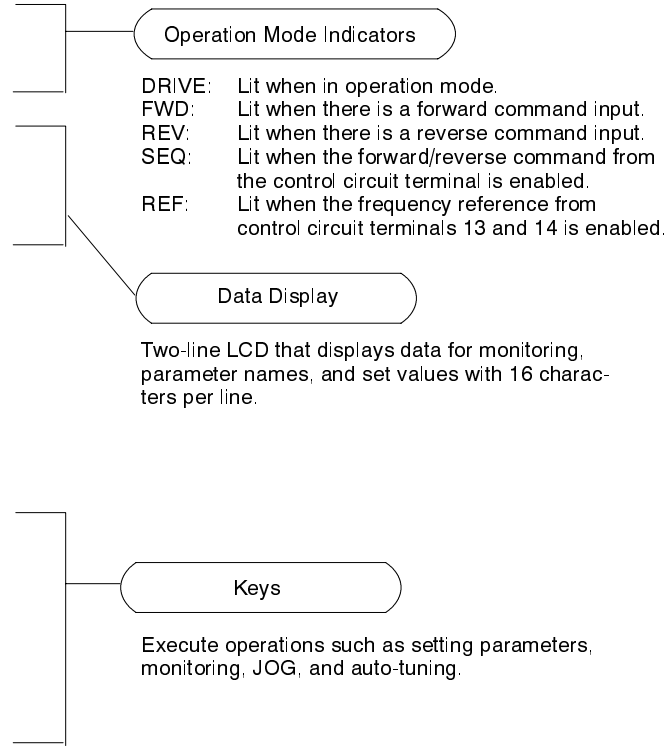
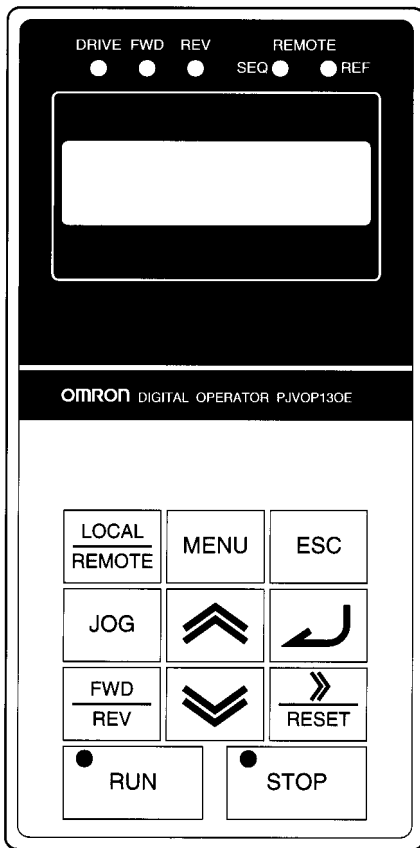

| Key | Name                                   | Function   |
|-----|--|--|
|     | Operation Mode Selection Key           | Switches between Operator and parameter setting (run command and frequency reference). This key can be enabled or disabled with a parameter setting (o2-02). |
|     | Menu Key                               | Displays each mode.  |
|     | Escape Key                             | Returns to the status before the Enter Key is pressed.   |
|     | Jog Key                                | Enables JOG operation when the 3G3FV is in operation with the Digital Operator.  |
|     | Forward/Reverse Rotation Selection Key | Selects the rotation direction of the motor when the 3G3FV is in operation with the Digital Operator.  |
|     | Reset/Digit Selection Key              | Selects digits for parameter settings. Also acts as the reset key when an fault has occurred.  |
|     | Increment Key                          | Selects modes, groups, functions, parameter names, and set values. This key increases numbers when pressed.  |
|     | Decrement Key                          | Selects modes, groups, functions, parameter names, and set values. This key decreases numbers when pressed.  |
|     | Enter Key                              | Enters modes, functions, constants, and set values after they are set.   |
|     | Run Key                                | Starts the 3G3FV running when the 3G3FV is in operation with the Digital Operator.   |
|     | Stop Key                               | Stops the 3G3FV running. This key can be enabled or disabled with a parameter setting (o2-02) in operation with the control circuit terminal.                |

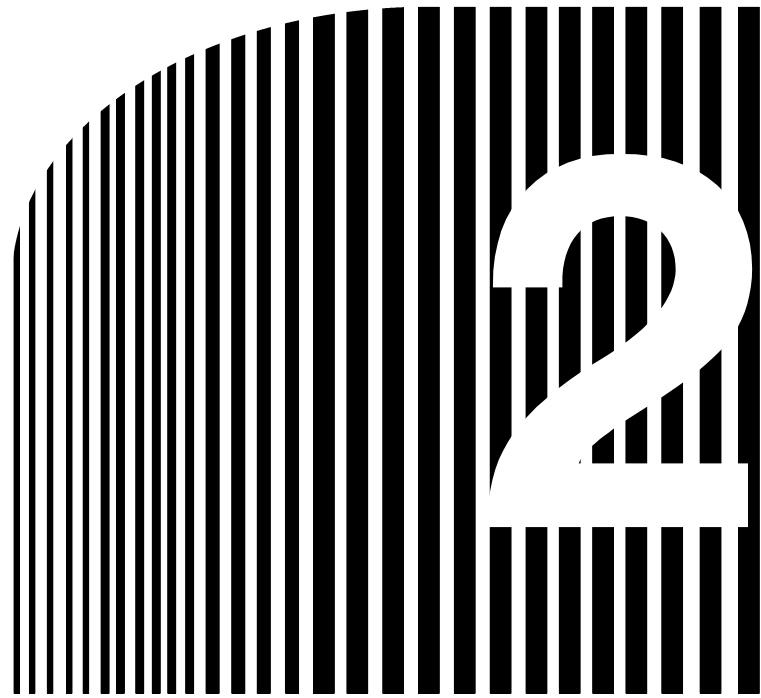

## Chapter 2

### • Installation •

2-1 Mounting

2-2 Wiring

2-1 Mounting

2-1-1 Dimensions

- 3G3FV-A2004/-A2007/-A2015/-A2022/-A2037  
3G3FV-A4004/-A4007/-A4015/-A4022/-A4037

● External Dimensions

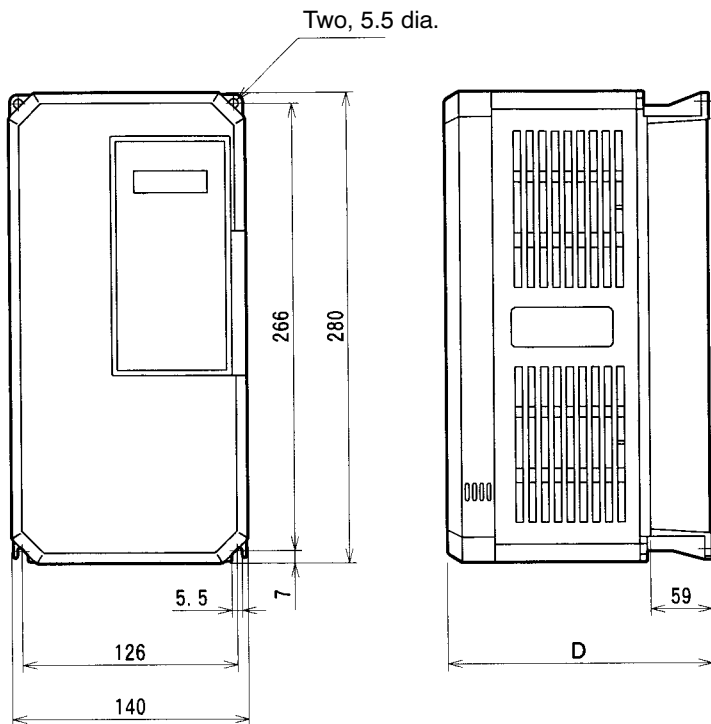

● Mounting Dimensions

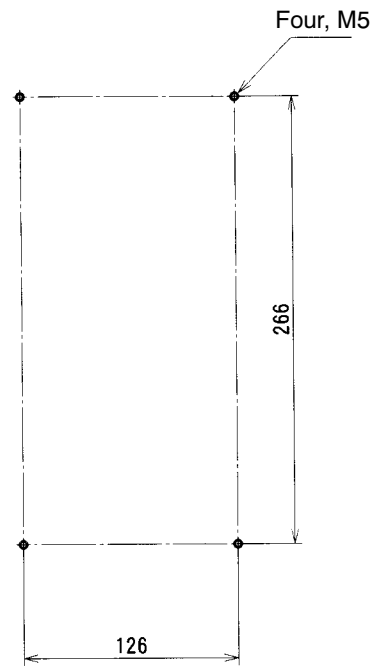

| Voltage class | Model 3G3FV-      | Dimensions (mm) |
|---------------|-------------------|-----------------|
|               |                   | D               |
| 200-V         | A2004/A2007/A2015 | 160             |
|               | A2022/A2037       | 180             |
| 400-V         | A4004/A4007       | 160             |
|               | A4015/A4022/A4037 | 180             |



■ 3G3FV-A2055/-A2075/-A4055/-A4075

● External Dimensions

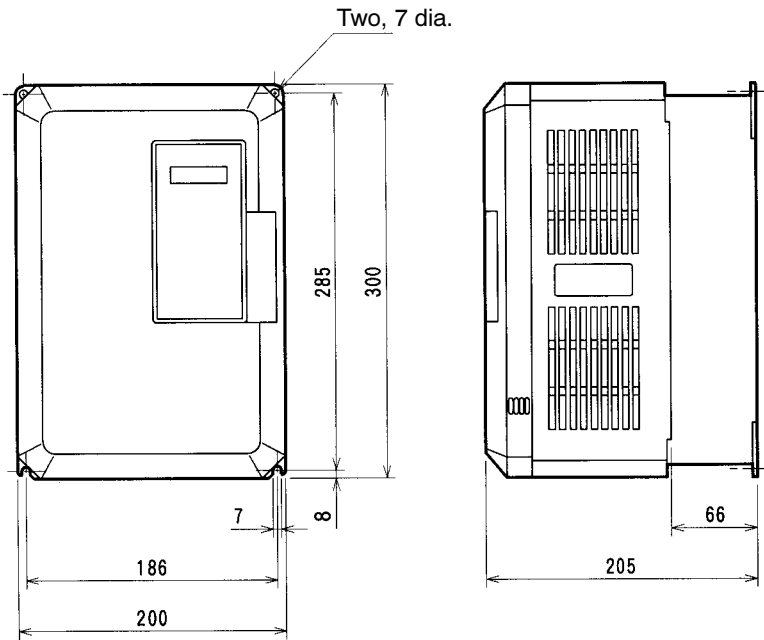

● Mounting Dimensions

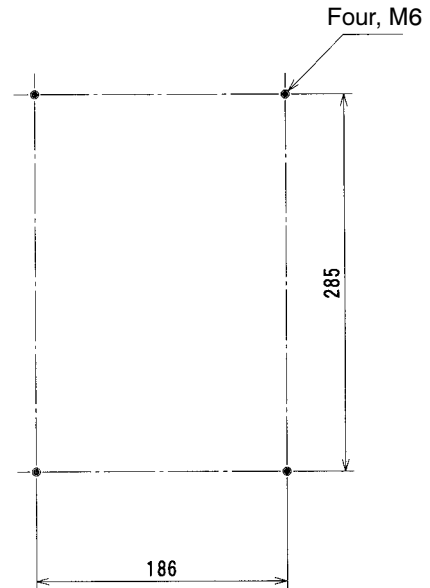

■ 3G3FV-A2110/-A2150/-A4110/-A4150

● External Dimensions

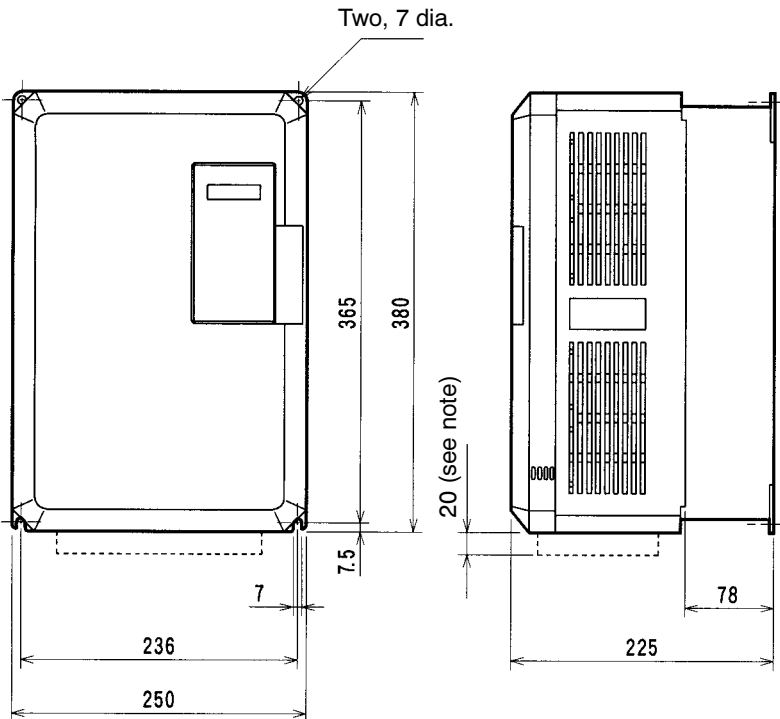

● Mounting Dimensions

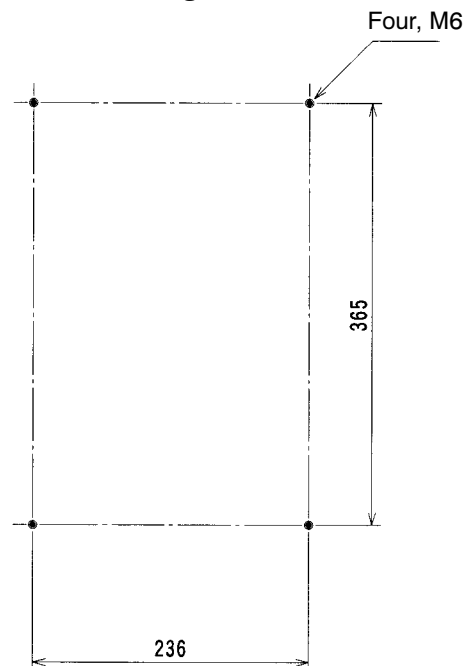

**Note** \*The dashed lines apply only to the A2150.

■ 3G3FV-B2185/-B2220/-B4185/-B4220/-B4300/-B4450

● External Dimensions

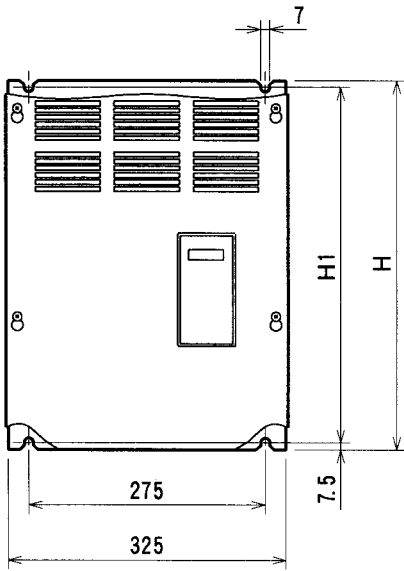

● Mounting Dimensions

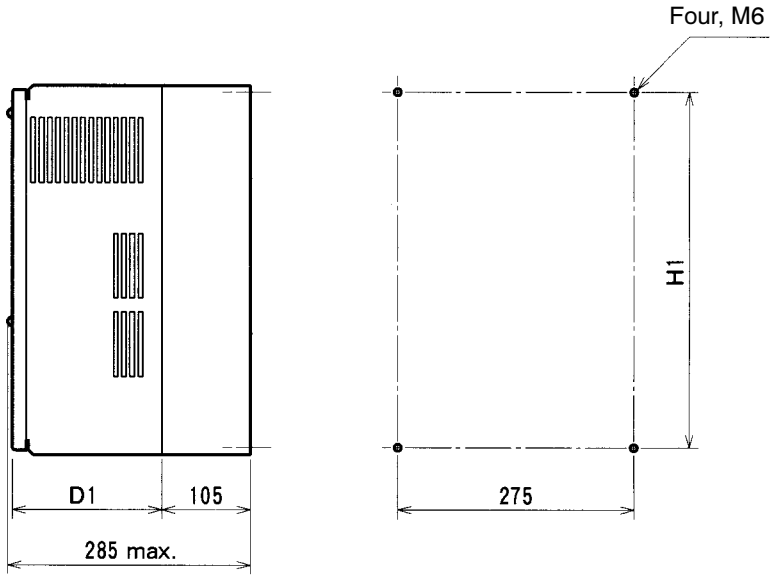

| Voltage class | Model 3G3FV-      | Dimensions (mm) |     |       |
|---------------|-------------------|-----------------|-----|-------|
|               |                   | H               | H1  | D1    |
| 200-V         | B2185/B2220       | 450             | 435 | 174.5 |
| 400-V         | B4185/B4220       | 450             | 435 | 174.5 |
|               | B4300/B4370/B4450 | 625             | 610 | 175   |

■ 3G3FV-B2300/-B2370/-B2450/-B2550/-B4550/-B4750-E

● External Dimensions

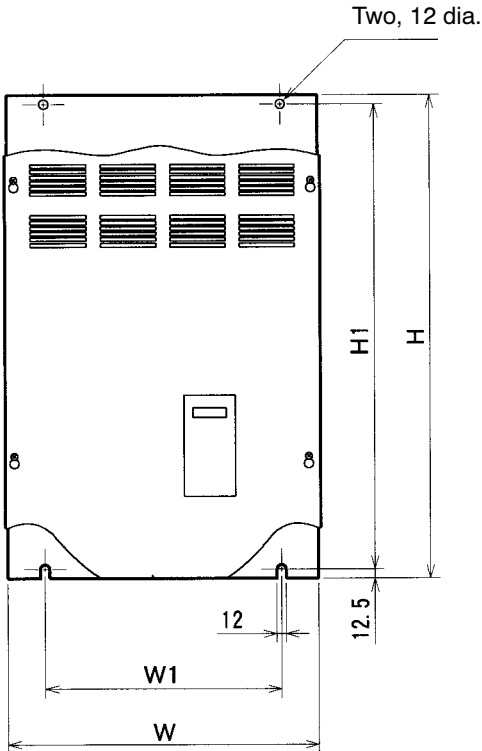

● Mounting Dimensions

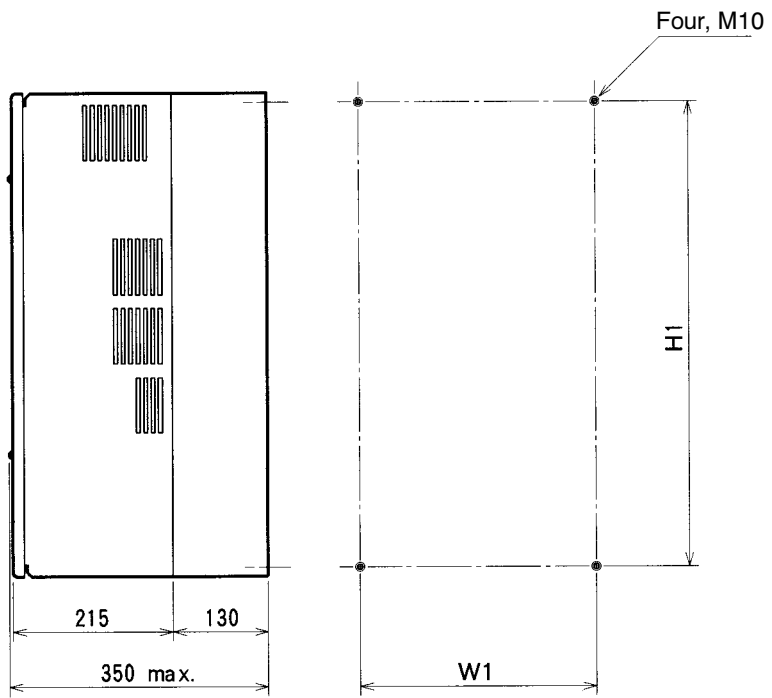

| Voltage class | Model 3G3FV-  | Dimensions (mm) |     |     |     |
|---------------|---------------|-----------------|-----|-----|-----|
|               |               | W               | H   | W1  | H1  |
| 200-V         | B2300B2370    | 425             | 675 | 320 | 650 |
|               | B2450/B2550   | 475             | 800 | 370 | 775 |
| 400-V         | B4550/B4750-E | 455             | 820 | 350 | 795 |

■ 3G3FV-B2750-E/-B411K-E/-B416K-E

● External Dimensions

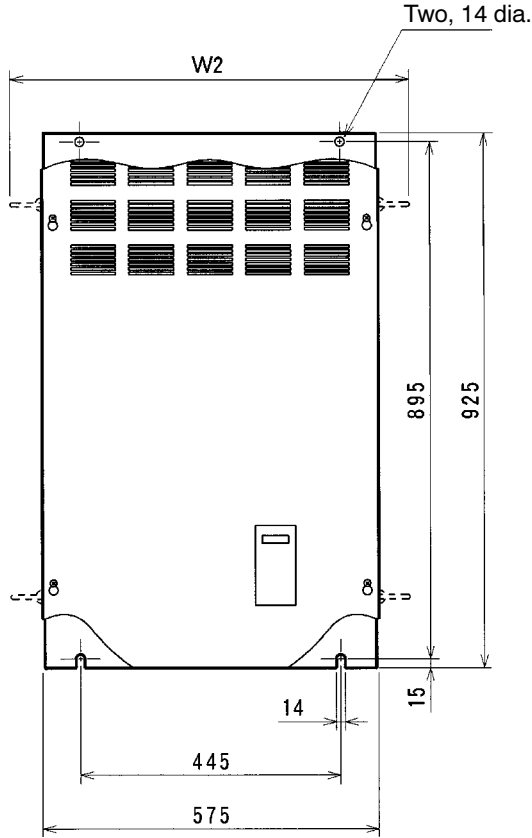

● Mounting Dimensions

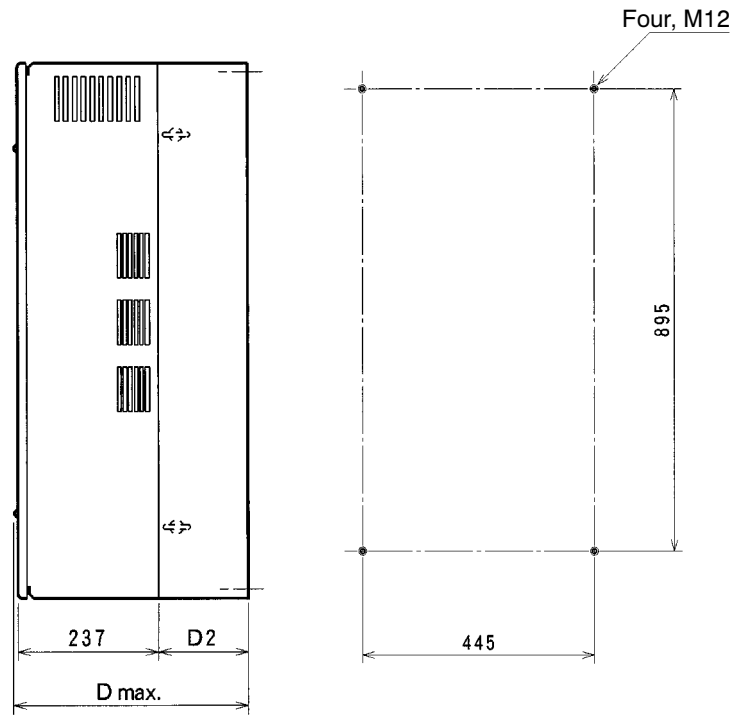

| Voltage class | Model 3G3FV- | Dimensions (mm) |     |     |
|---------------|--------------|-----------------|-----|-----|
|               |              | D               | D2  | W2  |
| 200-V         | B2750-E      | 400 max.        | 158 | 695 |
| 400-V         | B411K-E      | 375 max.        | 130 | 695 |
|               | B416K-E      | 400 max.        | 158 | 695 |

■ 3G3FV-B418K-E/-B422K-E

● External Dimensions

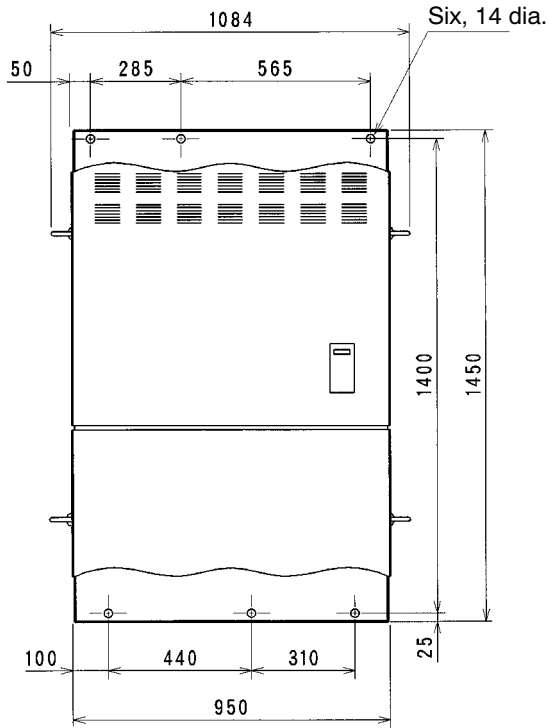

● Mounting Dimensions

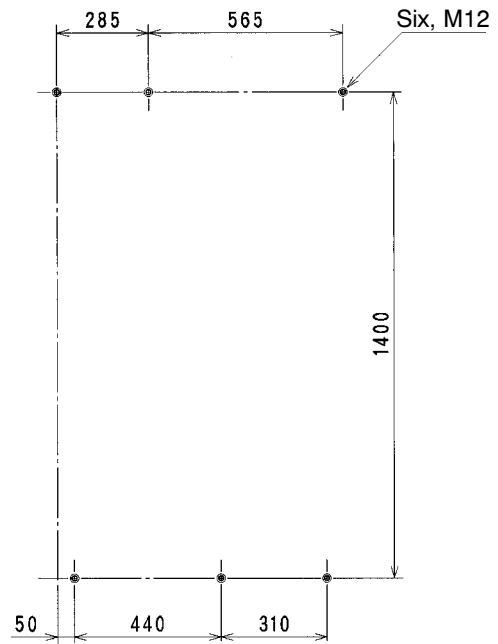

■ 3G3FV-B430K-E

● External Dimensions

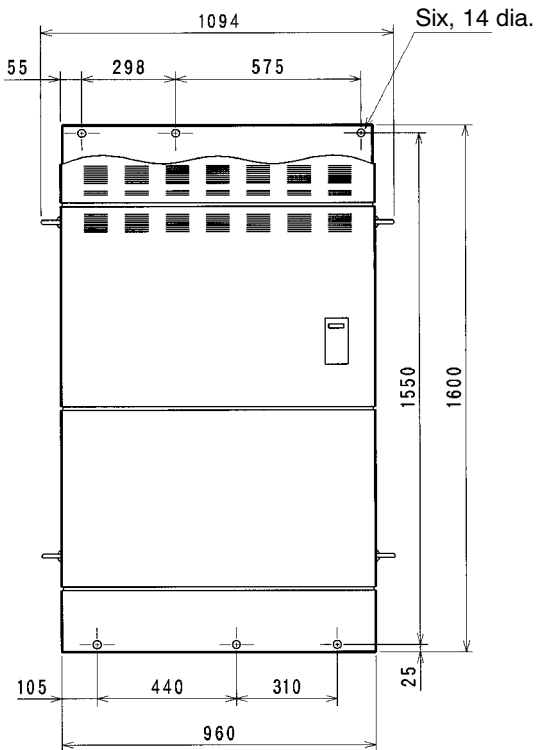

● Mounting Dimensions

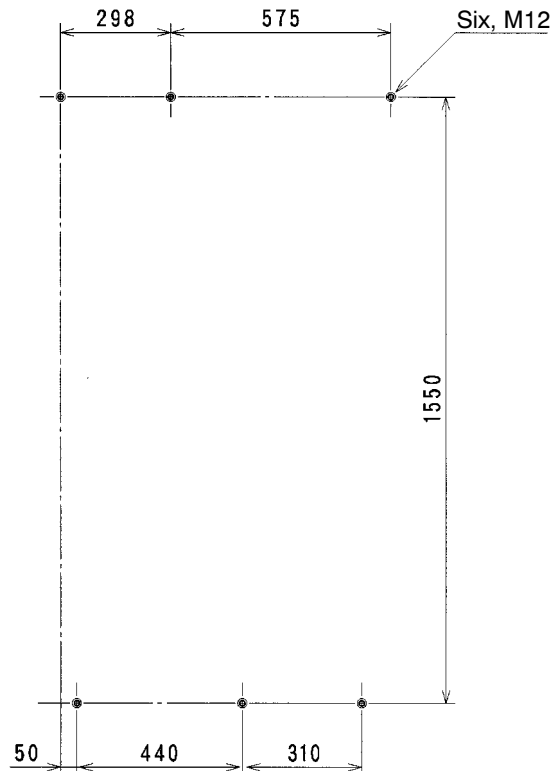

## 2-1-2 Installation Conditions

### ■ Cautions and Warnings

- ⚠ **Caution** Do not install the Inverter near combustible objects. Otherwise, a fire may occur.
- ⚠ **Caution** Do not install the Inverter in a place where it is exposed to dust or rubbish. Otherwise, a fire may occur.
- ⚠ **Caution** Prevent any foreign matter from entering into the Inverter. Otherwise, a fire or equipment trouble may occur.
- ⚠ **Caution** Provide specified spaces between the Inverter and the control panel and also between the Inverter and other units. Otherwise, a fire or equipment trouble may occur.
- ⚠ **Caution** Do not apply any strong impact to the Inverter. Otherwise, damage to the Inverter or cause equipment trouble may occur.
- ⚠ **WARNING** Install a stopping device for safety purposes. Otherwise, an injury may occur. (The holding brake is not a stopping device for safety purposes.)
- ⚠ **WARNING** Install an external emergency stop device so that the power supply can be turned OFF and operation can be stopped instantaneously in case of an emergency. Otherwise, an injury may occur.

### ■ Direction and Dimensions

- Install the Inverter on a vertical surface so that the characters on the nameplate are oriented upward.
- When installing the Inverter, always provide the following installation space to allow normal heat dissipation from the Inverter.

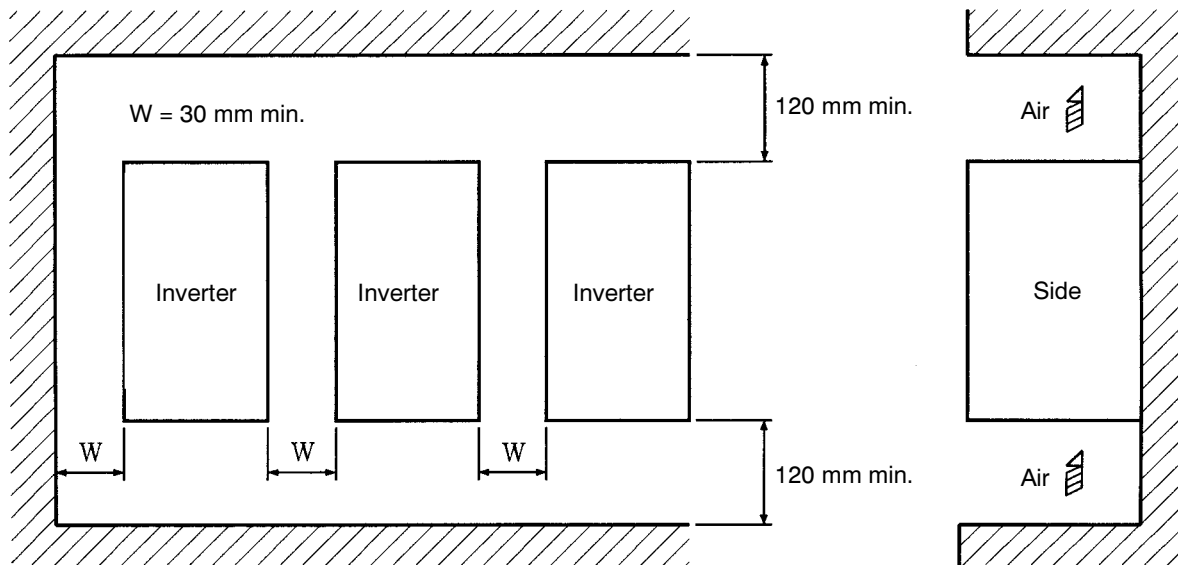

## ■ Installation Site

- Install the Inverter under the following conditions.

### **NEMA1 Type**

Ambient temperature for operation:  $-10^{\circ}\text{C}$  to  $40^{\circ}\text{C}$

Humidity: 90% RH or less (no condensation)

### **Open Chassis Type**

Ambient temperature for operation:  $-10^{\circ}\text{C}$  to  $45^{\circ}\text{C}$

Humidity: 90% RH or less (no condensation)

**Note** A protection cover is attached to the top and bottom of the Inverter. Be sure to remove the protection covers before installing the 200- or 400-V Class Inverter that has an output of 15 kW or less to a panel.

- Install the Inverter in a clean location free from oil mist and dust. Alternatively, install it in a totally enclosed panel that is completely shielded from floating dust.
- When installing or operating the Inverter, always take special care so that metal powder, oil, water, or other foreign matter does not get into the Inverter.
- Do not install the Inverter on inflammable material such as wood.

## ■ Ambient Temperature Control

- To enhance operation reliability, the Inverter should be installed in an environment free from extreme temperature rises.
- If the Inverter is installed in an enclosed environment such as a box, use a cooling fan or air conditioner to maintain the internal air temperature below  $45^{\circ}\text{C}$ .

## ■ Protecting Inverter from Foreign Matter During Installation









- Place a cover over the Inverter during installation to shield it from metal power produced by drilling.
- Upon completion of installation, always remove the cover from the Inverter. Otherwise, ventilation will be affected, causing the Inverter to overheat.

---

## 2-2 Wiring

---

### ■ Cautions and Warnings

-  **WARNING** Be sure that the power supply is turned OFF before wiring. Wait for at least one minute (three minutes for 30-kW or larger models) after turning off the power supply. Otherwise, an electric shock may occur.
-  **WARNING** Wiring must be performed by authorized persons specialized in electrical work. Otherwise, an electric shock or fire may occur.
-  **WARNING** Be sure to check for proper operation after wiring the emergency stop circuit. Otherwise, physical injury may occur.
-  **WARNING** Be sure to ground the ground terminal. Otherwise, an electric shock or fire may occur.
-  **WARNING** Be sure to confirm that the rated voltage of the Inverter coincides with the voltage of the AC power supply. Otherwise, a fire, injury, or equipment trouble may occur.
-  **WARNING** When connecting the braking resistor, Braking Resistor Unit, or Braking Unit, be sure to follow the instructions specified in the Operation Manual. Otherwise, a fire may occur.
-  **WARNING** Be sure to wire correctly. Otherwise, injury or equipment damage may occur.
-  **WARNING** Be sure to firmly tighten the screws on the terminal block. Otherwise, a fire, injury, or equipment damage may occur.
-  **Caution** Do not connect the AC power to the output terminal U, V, or W. Otherwise, equipment damage or trouble may occur.



## 2-2-1 Removing and Mounting the Front Cover

---

Remove the front cover to wire the terminals. Remove the Digital Operator from the front cover before removing the front cover. For models of 15 kW or less (both 200-V and 400-V class), do not remove or mount the front cover without first removing the Digital Operator; otherwise the Digital Operator may malfunction due to imperfect contact.

---

### ■ Removing the Cover (Models of 15 kW or Less)

#### • Removing the Digital Operator

Press the lever on the side of the Digital Operator in the arrow ① direction to unlock the Digital Operator and lift the Digital Operator in the arrow ② direction to remove the Digital Operator as shown in the following illustration.

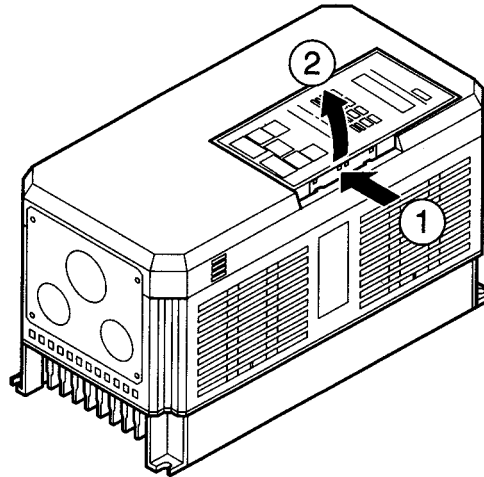

#### • Removing the Front Cover

Press the left and right sides of the front cover in the arrow ① directions and lift the bottom of the cover in the arrow ② direction to remove the front cover as shown in the following illustration.

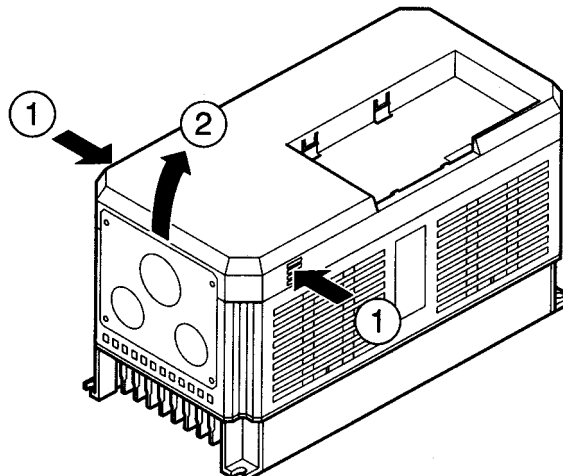

### • Mounting the Front Cover

Mount the front cover to the Inverter by taking in reverse order to the steps to remove the front cover after wiring the terminals.

Do not mount the front cover with the Digital Operator attached to the front cover, otherwise Digital Operator may malfunction due to imperfect contact.

Insert the tab of the upper part of the front cover into the groove of the Inverter and press the lower part of the front cover onto the Inverter until the front cover snaps shut.

### ■ Mounting the Digital Operator

- Hook the Digital Operator on clicks A of the front cover in the arrow ① direction as shown in the following illustration.
- Press the Digital Operator in the arrow ② direction until it snaps shut with clicks B.

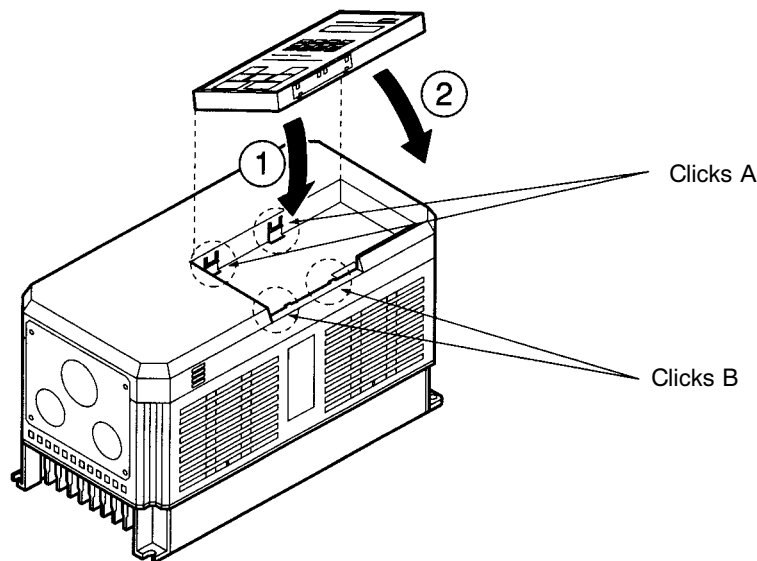

**Note** Do not remove or attach the Digital Operator or mount or remove the front cover using methods other than those mentioned above, otherwise the Inverter may malfunction due to imperfect contact or break.

### ■ Removing the Front Cover of Inverters with 18.5-kW Output or More

- The front cover can be removed without removing the Digital Operator from the Inverter provided that the Inverter model is one with an output of 18.5 kW or more.
- Loosen the four screws of the front cover and move the front cover slightly upwards to remove the front cover.

2-2-2 Terminals

■ Terminal Block Configuration (200-V Class with 0.4-kW Output)

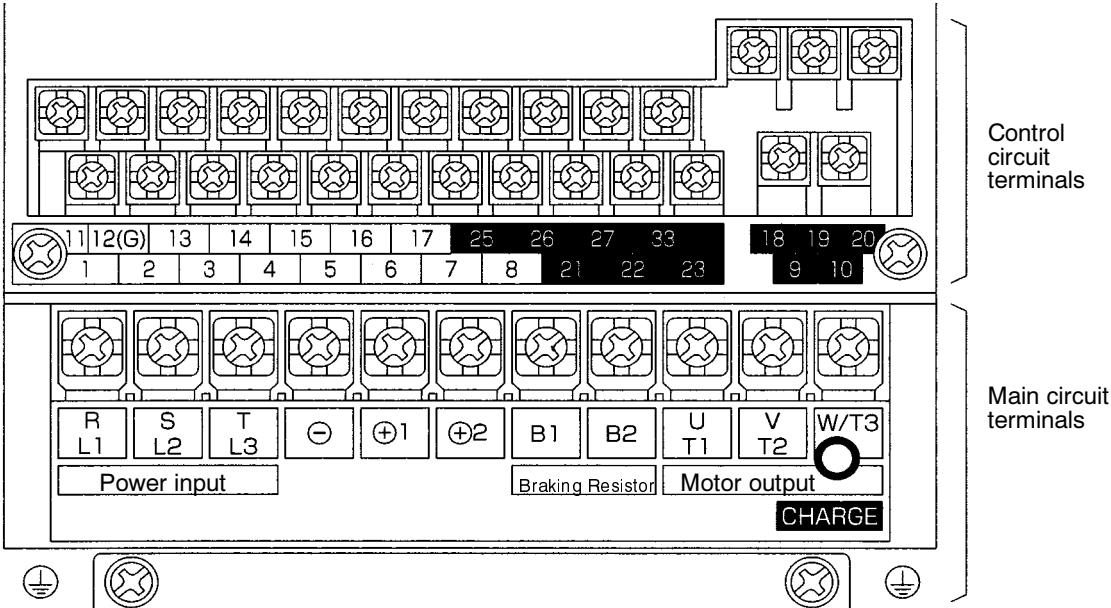

■ Main Circuit Terminals

● 200-V Class

| Model 3G3FV-                   | A2004 to A2075  | A2110 to A2150                              | B2185 to B2220                              | B2300 to B2750-E  |
|--------------------------------|---|---|---|---|
| Maximum applied motor capacity | 0.4 to 7.5 kW   | 11 to 15 kW                                 | 18.5 to 22 kW                               | 30 to 75 kW   |
| L1 (R)                         | Power supply input terminals, 3-phase, 200 to 230 VAC, 50/60 Hz               |   |   |   |
| L2 (S)                         |   |   |   |   |
| L3 (T)                         |   |   |   |   |
| T1 (U)                         | Motor output terminals, 3-phase, 200 to 230 VAC (correspond to input voltage) |   |   |   |
| T2 (V)                         |   |   |   |   |
| T3 (W)                         |   |   |   |   |
| B1                             | Braking Resistor Unit connection terminals                                    | ---   |   |   |
| B2                             |   |   |   |   |
| ⊕ 1                            | DC reactor connection terminal<br>(⊕ 1-⊕ 2)                                   | DC reactor connection terminal<br>(⊕ 1-⊕ 2) | DC power supply input terminal<br>(⊕ 1-⊖)   | ---   |
| ⊕ 2                            |   |   |   |   |
| ⊖                              | DC power supply input terminal<br>(⊕ 1-⊖)                                     | DC power supply input terminal<br>(⊕ 1-⊖)   | Braking Unit connection terminal<br>(⊕ 3-⊖) | Braking Unit connection terminal<br>(⊕ 3-⊖)<br>See note 1 |
| ⊕ 3                            |   |   |   |   |
| s                              | ---   |   | Cooling fan power supply input terminal     | See note 2  |
| r                              |   |   |   |   |
| s200                           | ---   |   |   |   |
| s400                           | ---   |   |   |   |
| ⊕                              | Ground the terminal at a resistance of less than 100 Ω.                       |   |   |   |

**Note 1.** Don't connect a DC power supply. Otherwise, equipment trouble may occur.

**Note 2.** These are the cooling fan power supply and control circuit power supply input terminals.

● 400-V Class

| Model 3G3FV-                   | A4004 to A4150  | B4185 to B4450                            | B4550 to B416K-E  | B418K-E to B430K-E  |
|--------------------------------|---|---|---|---|
| Maximum applied motor capacity | 0.4 to 15 kW  | 18.5 to 45 kW                             | 55 to 160 kW  | 185 to 300 kW   |
| L1 (R)                         | Power supply input terminals, 3-phase, 380 to 460 VAC, 50/60 Hz               |   |   |   |
| L2 (S)                         |   |   |   |   |
| L3 (T)                         |   |   |   |   |
| T1 (U)                         | Motor output terminals, 3-phase, 380 to 460 VAC (correspond to input voltage) |   |   |   |
| T2 (V)                         |   |   |   |   |
| T3 (W)                         |   |   |   |   |
| B1                             | Braking Resistor Unit connection terminals                                    | ---                                       |   |   |
| B2                             |   |   |   |   |
| ⊕ 1                            | DC reactor connection terminal<br>(⊕ 1-⊕ 2)                                   | DC power supply input terminal<br>(⊕ 1-⊖) | ---   | DC power supply input terminal<br>(⊕ 1-⊖)                 |
| ⊕ 2                            |   |   |   |   |
| ⊖                              | ---   | Cooling fan power supply input terminal   | Braking Unit connection terminal<br>(⊕ 3-⊖)<br>See note 1 | Braking Unit connection terminal<br>(⊕ 3-⊖)<br>See note 1 |
| ⊕ 3                            |   |   |   |   |
| s                              | ---   | ---                                       | ---   | ---   |
| r                              |   |   |   |   |
| s200                           | ---   | ---                                       | ---   | ---   |
| s400                           |   |   |   |   |
| Ⓧ                              | Ground the terminal at a resistance of less than 10 Ω.                        |   |   |   |

**Note 1.** Don't connect a DC power supply. Otherwise, equipment trouble may occur.

**Note 2.** These are the cooling fan power supply and control circuit power supply input terminals.

**Note 3.** When 200-V is used, input 200 to 230 VAC from r – s200. When 400-V is used, input 380 to 460 VAC from r – s400.

■ Control Circuit Terminals for All 3G3FV Models

| Symbol | Name | Function                                   | Signal level  |   |
|--------|------|--|---|---|
| Input  | 1    | Forward/Stop                               | Forward at ON. Stops at OFF.  | Photocoupler<br>24 VDC, 8 mA                                      |
|        | 2    | Reverse/Stop                               | Reverse at ON. Stops at OFF.  |   |
|        | 3    | Multi-function contact input 1             | Set by parameter H1-01 (external fault a).  |   |
|        | 4    | Multi-function contact input 2             | Set by parameter H1-02 (fault reset).   |   |
|        | 5    | Multi-function contact input 3             | Set by parameter H1-03 (multi-step reference 1).  |   |
|        | 6    | Multi-function contact input 4             | Set by parameter H1-04 (multi-step reference 2).  |   |
|        | 7    | Multi-function contact input 5             | Set by parameter H1-05 (jog frequency reference)  |   |
|        | 8    | Multi-function contact input 6             | Set by parameter H1-06 (external base-block N.O.)   |   |
|        | 11   | Sequence input common                      | Common for 1 to 8.  |   |
| Input  | 15   | Frequency reference power supply (15 VDC)  | 15-VDC power supply for frequency reference.  | 15 VDC (±10%), 20 mA max.   |
|        | 33   | Frequency reference power supply (-15 VDC) | -15-VDC power supply for frequency reference.   | -15 VDC (±10%), 20 mA max.  |
|        | 13   | Frequency reference input (voltage)        | Frequency reference voltage input terminal<br>Either 0 to +10 V or 0 to ±10 V can be selected as the parameter (H3-01). | 0 to 10 VDC (20 kΩ)<br>0 to ±10 V (20 kΩ)                         |
|        | 14   | Frequency reference input (current)        | Current input terminal for frequency reference.   | 4 to 20 mA (250 kΩ)   |
|        | 16   | Multi-function analog input                | Set by parameter H3-05.   | ---   |
|        | 17   | Frequency reference input common           | Common for analog input signal.   | ---   |
|        | 12   | Shielded wire connection ground            | Shielded terminal for sequence input, frequency reference input.  | ---   |
| Output | 9    | Multi-function contact output              | Set by parameter H2-01 (during running).  | Contact output (SPST-NO)<br>30 VDC, 1 A max.<br>250 VAC, 1 A max. |
|        | 10   | Multi-function contact output common       |   |   |
|        | 25   | Multi-function output 1                    | Set by parameter H2-02 (zero speed detection).  | Open collector output<br>48 V, 50 mA max.                         |
|        | 26   | Multi-function output 2                    | Set by parameter H2-03 (agree output reference detection).  |   |
|        | 27   | Multi-function output 1 and 2 common       | Common for terminals, 25, 26.   |   |
|        | 18   | Fault output (NO condition)                | When fault occurs:<br>Terminals 18 to 20: Closed<br>Terminals 19 to 20: Open  | Contact output (SPDT)<br>30 VDC, 1 A max.<br>250 VAC, 1 A max.    |
|        | 19   | Fault output (NC condition)                |   |   |
|        | 20   | Fault output common                        |   |   |
| Output | 21   | Multi-function analog output 1             | Set by parameter H4-01. (Output frequency: 0 to ±10 V/±100% frequency)  | 0 to ±10 VDC (±5%), 0 to 10 VDC (±5%), 2 mA max.                  |
|        | 23   | Multi-function analog output 2             | Set by parameter H4-01. (Output current: 5 V/Inverter rated current)  |   |
|        | 22   | Multi-function analog output common        | Common for analog output.   |   |

**Note** The settings shown in parentheses in the “Function” column for the multi-function inputs and multi-function contact outputs indicate default settings.

## 2-2-3 Standard Connection Diagram

### ■ Main Circuit Terminal Connections

#### ● 3G3FV-A2004 to A2075, A4004 to A4150

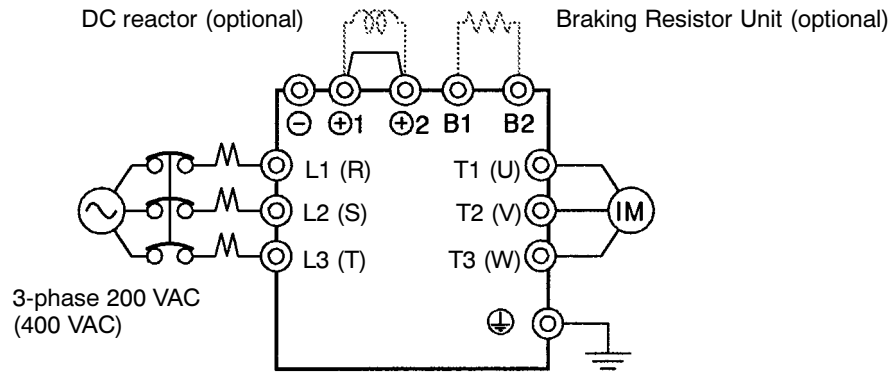

**Note:** Be sure to remove the short bar before connecting a DC reactor.

#### ● 3G3FV-A2110 to A2150

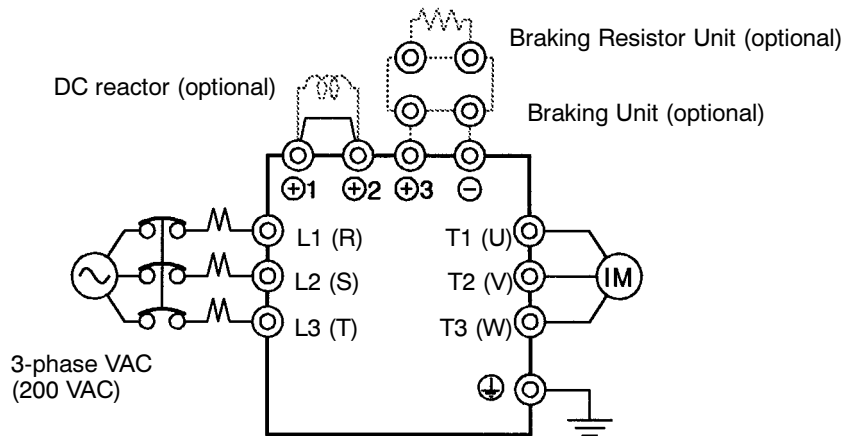

**Note:** Be sure to remove the short bar before connecting a DC reactor.

● 3G3FV-B2185 to B2220, B4185 to B4450

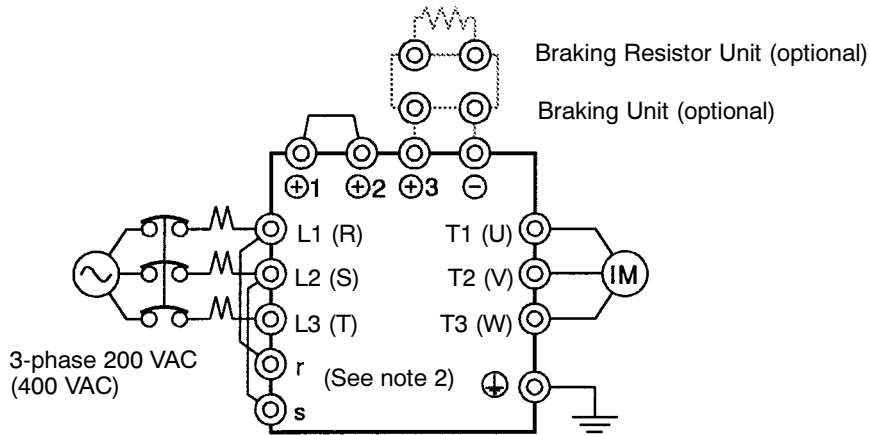

**Note:** The DC reactor is built in.

● 3G3FV-B2300 to B2550

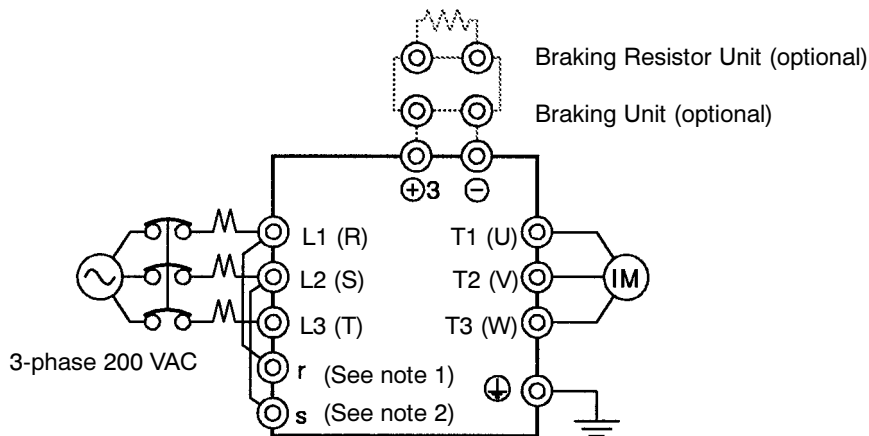

**Note:** The DC reactor is built in.

**Note 1.** For 200-V class, 30 to 75 kW (B2300 to B2750-E) and 400-V class, 55 to 300 kW (B4550 to B430K), input the control circuit power supply from r–s. (For others, create the control power supply internally from the main circuit DC power supply.)

**Note 2.** The r–L1 (R) and s–L2 (S) terminals are short-circuited for shipping.



● 3G3FV-B2750-E

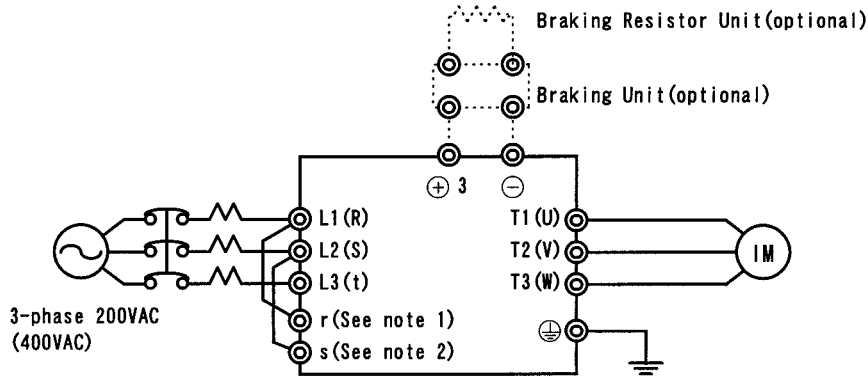

**Note:** The DC reactor is built in.

**Note 1.** For 200-V class, 30 to 75 kW (B2300 to B2750-E) and 400-V class, 55 to 300 kW (B4550-E to B430K-E), input the control circuit power supply from r-s. (For others, create the control power supply internally from the main circuit DC power supply.)

**Note 2.** The r-L1 (R) and s-L2 (S) terminals are short-circuited for shipping.

● 3G3FV-B4550 to B416K-E

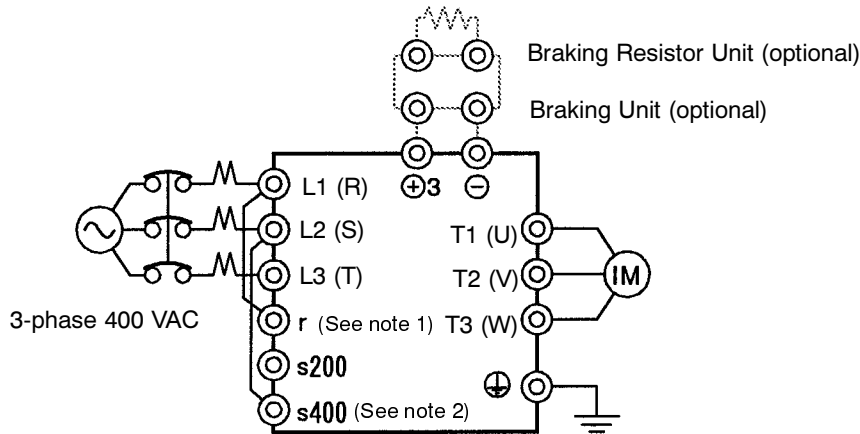

**Note:** The DC reactor is built in.

**Note 1.** For 200-V class, 30 to 75 kW (B2300 to B2750-E) and 400-V class, 55 to 300 kW (B4550-E to B430K-E), input the control circuit power supply from r-s. (For others, create the control power supply internally from the main circuit DC power supply.)

**Note 2.** The r-L1 (R) and s (s400)-L2 (S) terminals are short-circuited for shipping.

● 3G3FV-B418K-E to B430K-E

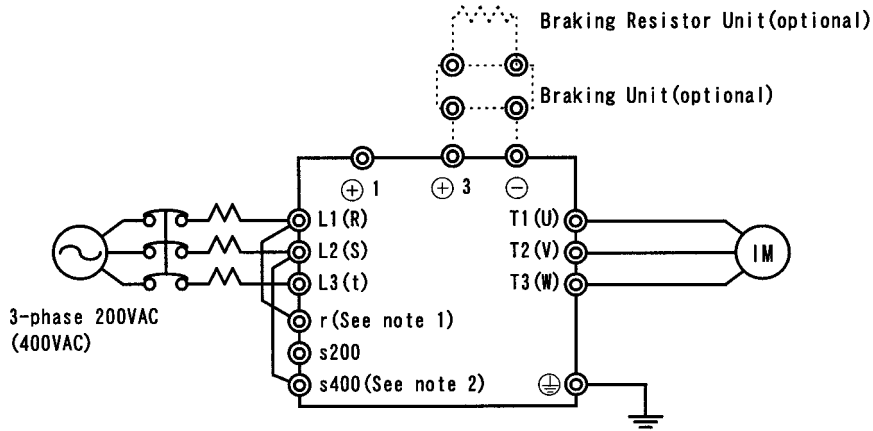

**Note:** Models of 185 to 300 kW can not use the DC reactor.

- Note 1.** For 200-V class, 30 to 75 kW (B2300 to B2750-E) and 400-V class, 55 to 300 kW (B4550-E to B430K-E), input the control circuit power supply from r-s. (For others, create the control power supply internally from the main circuit DC power supply.)
- Note 2.** The r-L1 (R) and s (s400)-L2 (S) terminals are short-circuited for shipping.

■ Control Circuit Terminal Connections (All Models)

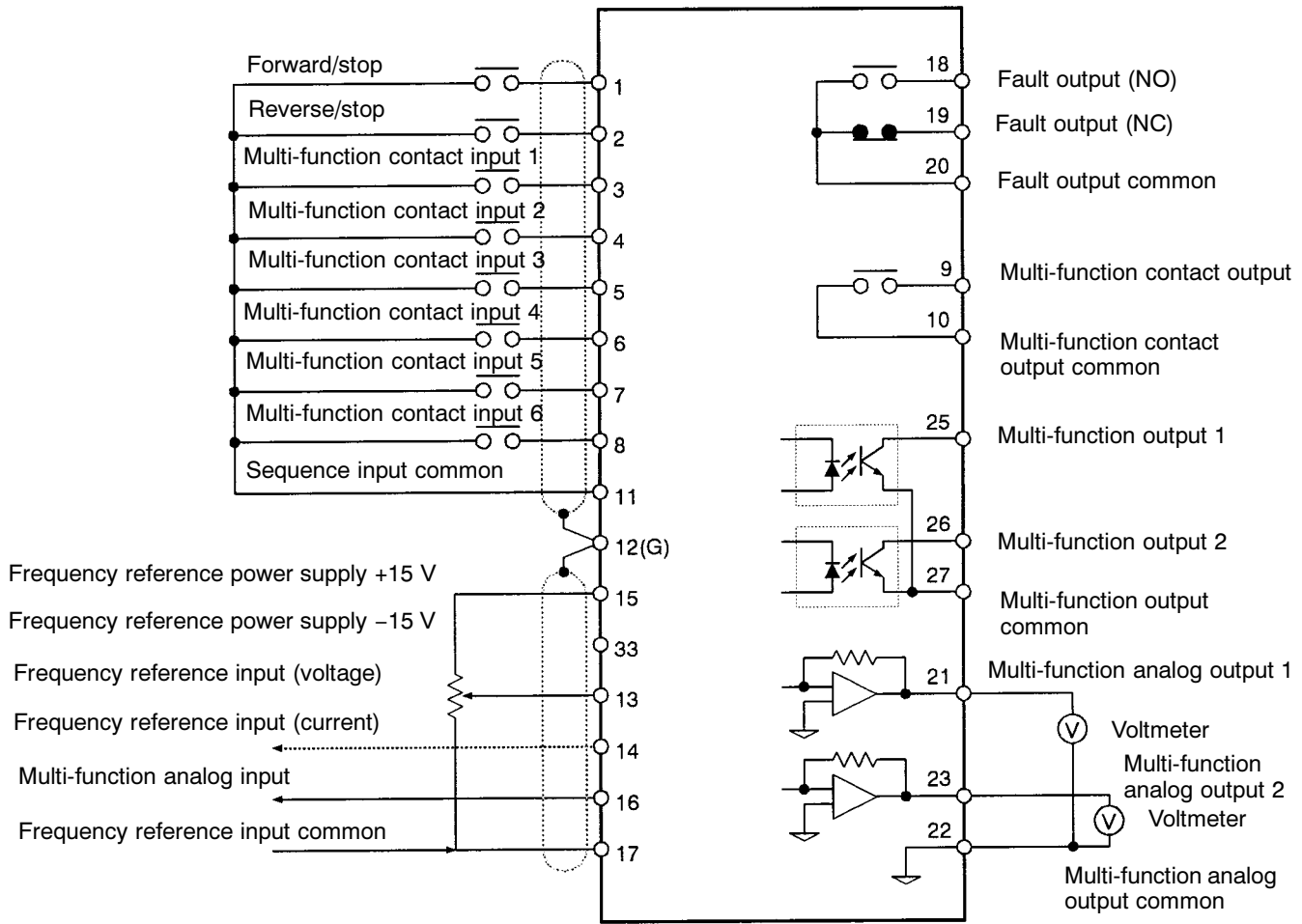

2-2-4 Wiring Around the Main Circuit

---















System reliability and noise resistance are affected by the wiring method used. Therefore, always follow the instructions given below when connecting the Inverter to peripheral devices and other parts.

---

■ Wire Size and Round Solderless Terminal













For the main circuit and ground, always use 600-V polyvinyl chloride (PVC) cables. If the cable is long and may cause voltage drops, increase the wire size according to the cable length.









• Wire Sizes

| Voltage class   | Model   | Terminal  | Terminal screw | Wire thickness (mm <sup>2</sup> ) |
|---|---|---|----------------|-----------------------------------|
| 200-V Class   | 3G3FV-A2004   | L1, L2, L3, (-), (+)1, (+)2, B1, B2, T1, T2, T3                                     | M4             | 2 to 5.5                          |
|   |   |    |                |                                   |
|   | 3G3FV-A2007   | L1, L2, L3, (-), (+)1, (+)2, B1, B2, T1, T2, T3                                     | M4             | 2 to 5.5                          |
|   |   |    |                |                                   |
|   | 3G3FV-A2015   | L1, L2, L3, (-), (+)1, (+)2, B1, B2, T1, T2, T3                                     | M4             | 2 to 5.5                          |
|   |   |    |                | 3.5 to 5.5                        |
|   | 3G3FV-A2022   | L1, L2, L3, (-), (+)1, (+)2, B1, B2, T1, T2, T3                                     | M4             | 3.5 to 5.5                        |
|   |   |    |                |                                   |
|   | 3G3FV-A2037   | L1, L2, L3, (-), (+)1, (+)2, B1, B2, T1, T2, T3                                     | M4             | 5.5                               |
|   |   |    |                |                                   |
|   | 3G3FV-A2055   | L1, L2, L3, (-), (+)1, (+)2, B1, B2, T1, T2, T3                                     | M5             | 8                                 |
|   |   |    |                | 5.5 to 8                          |
|   | 3G3FV-A2075   | L1, L2, L3, (-), (+)1, (+)2, B1, B2, T1, T2, T3                                     | M5             | 8                                 |
|   |   |    |                | 5.5 to 8                          |
|   | 3G3FV-A2110   | L1, L2, L3, (-), (+)1, (+)2, (+)3, T1, T2, T3                                       | M6             | 22                                |
|   |   |   |                | 8                                 |
|   | 3G3FV-A2150   | L1, L2, L3, (-), (+)1, (+)2, (+)3, T1, T2, T3                                       | M8             | 30                                |
|   |   |  | M6             | 8                                 |
|   | 3G3FV-B2185   | L1, L2, L3, (-), (+)1, (+)2, (+)3, T1, T2, T3                                       | M8             | 30                                |
|   |   |  |                | 14                                |
|   |   | r, s  | M4             | 0.5 to 5.5                        |
|   | 3G3FV-B2220   | L1, L2, L3, (-), (+)1, (+)2, (+)3, T1, T2, T3                                       | M8             | 38                                |
|   |   |  |                | 14                                |
|   |   | r, s  | M4             | 0.5 to 5.5                        |
|   | 3G3FV-B2300   | L1, L2, L3, (-), (+)3, T1, T2, T3   | M10            | 100                               |
|   |   |  | M8             | 22                                |
|   |   | r, s  | M4             | 0.5 to 5.5                        |
|   | 3G3FV-B2370   | L1, L2, L3, (-), (+)3, T1, T2, T3   | M10            | 60 x 2P                           |
|  |   | M8  | 22             |                                   |
| r, s  |   | M4  | 0.5 to 5.5     |                                   |
| 3G3FV-B2450   | L1, L2, L3, (-), (+)3, T1, T2, T3   | M10   | 60 x 2P        |                                   |
|   |  | M8  | 22             |                                   |
|   | r, s  | M4  | 0.5 to 5.5     |                                   |
| 3G3FV-B2550   | L1, L2, L3, (-), (+)3, T1, T2, T3   | M10   | 60 x 2P        |                                   |
|   |  | M8  | 30             |                                   |
|   | r, s  | M4  | 0.5 to 5.5     |                                   |

| Voltage class | Model         | Terminal  | Terminal screw | Wire thickness (mm <sup>2</sup> ) |
|---------------|---------------|---|----------------|-----------------------------------|
| 200-V Class   | 3G3FV-B2750-E | L1, L2, L3, (-), (+)3, T1, T2, T3   | M12            | 100 x 2P                          |
|               |               |  | M8             | 50                                |
|               |               | r, s  | M4             | 0.5 to 5.5                        |

**Note** The wire thickness is set for copper wires at 75°C.

| Voltage class | Model   | Terminal  | Terminal screw | Wire thickness (mm <sup>2</sup> ) |
|---------------|---|---|----------------|-----------------------------------|
| 400-V Class   | 3G3FV-A4004   | L1, L2, L3, (-), (+)1, (+)2, B1, B2, T1, T2, T3                                     | M4             | 2 to 5.5                          |
|               |   |    |                |                                   |
|               | 3G3FV-A4007   | L1, L2, L3, (-), (+)1, (+)2, B1, B2, T1, T2, T3                                     | M4             | 2 to 5.5                          |
|               |   |    |                |                                   |
|               | 3G3FV-A4015   | L1, L2, L3, (-), (+)1, (+)2, B1, B2, T1, T2, T3                                     | M4             | 2 to 5.5                          |
|               |   |    |                |                                   |
|               | 3G3FV-A4022   | L1, L2, L3, (-), (+)1, (+)2, B1, B2, T1, T2, T3                                     | M4             | 2 to 5.5                          |
|               |   |    |                |                                   |
|               | 3G3FV-A4037   | L1, L2, L3, (-), (+)1, (+)2, B1, B2, T1, T2, T3                                     | M4             | 2 to 5.5                          |
|               |   |  |                | 3.5 to 5.5                        |
|               | 3G3FV-A4055   | L1, L2, L3, (-), (+)1, (+)2, B1, B2, T1, T2, T3                                     | M4             | 3.5 to 5.5                        |
|               |   |  |                |                                   |
|               | 3G3FV-A4075   | L1, L2, L3, (-), (+)1, (+)2, B1, B2, T1, T2, T3                                     | M5             | 5.5                               |
|               |   |  |                |                                   |
|               | 3G3FV-A4110   | L1, L2, L3, (-), (+)1, (+)2, B1, B2, T1, T2, T3                                     | M5             | 8 to 14                           |
|               |   |  | M6             | 8                                 |
|               | 3G3FV-A4150   | L1, L2, L3, (-), (+)1, (+)2, B1, B2, T1, T2, T3                                     | M5             | 8 to 14                           |
|               |   |  | M6             | 8                                 |
|               | 3G3FV-B4185   | L1, L2, L3, (-), (+)1, (+)2, (+)3, T1, T2, T3                                       | M6             | 14                                |
|               |   |  | M8             | 8                                 |
|               |   | r, s  | M4             | 0.5 to 5.5                        |
|               | 3G3FV-B4220   | L1, L2, L3, (-), (+)1, (+)2, (+)3, T1, T2, T3                                       | M6             | 22                                |
|               |   |  | M8             | 8                                 |
|               |   | r, s  | M4             | 0.5 to 5.5                        |
| 3G3FV-B4300   | L1, L2, L3, (-), (+)1, (+)2, (+)3, T1, T2, T3                                       | M8  | 22             |                                   |
|               |  |   | 8              |                                   |
|               | r, s  | M4  | 0.5 to 5.5     |                                   |
| 3G3FV-B4370   | L1, L2, L3, (-), (+)1, (+)2, (+)3, T1, T2, T3                                       | M8  | 30             |                                   |
|               |  |   | 14             |                                   |
|               | r, s  | M4  | 0.5 to 5.5     |                                   |

| Voltage class | Model   | Terminal  | Terminal screw | Wire thickness (mm <sup>2</sup> ) |
|---------------|---|---|----------------|-----------------------------------|
| 400-V Class   | 3G3FV-B4450   | L1, L2, L3, (-), (+)1, (+)2, (+)3, T1, T2, T3                                       | M8             | 50                                |
|               |   |    |                | 14                                |
|               |   | r, s  | M4             | 0.5 to 5.5                        |
|               | 3G3FV-B4550   | L1, L2, L3, (-), (+)3, T1, T2, T3   | M10            | 100                               |
|               |   |    | M8             | 22                                |
|               |   | r, s200, s400   | M4             | 0.5 to 5.5                        |
|               | 3G3FV-B4750-E   | L1, L2, L3, (-), (+)3, T1, T2, T3   | M10            | 60 x 2P                           |
|               |   |    | M8             | 22                                |
|               |   | r, s200, s400   | M4             | 0.5 to 5.5                        |
|               | 3G3FV-B411K-E   | L1, L2, L3, (-), (+)3, T1, T2, T3   | M10            | 60 x 2P                           |
|               |   |    | M8             | 30                                |
|               |   | r, s200, s400   | M4             | 0.5 to 5.5                        |
|               | 3G3FV-B416K-E   | L1, L2, L3, (-), (+)3, T1, T2, T3   | M12            | 100 x 2P                          |
|               |   |    | M8             | 50                                |
|               |   | r, s200, s400   | M4             | 0.5 to 5.5                        |
|               | 3G3FV-B418K-E   | L1, L2, L3, (-), (+)1, (+)3, T1, T2, T3   | M16            | 325 x 2P                          |
|               |   |    | M8             | 50                                |
|               |   | r, s200, s400   | M4             | 0.5 to 5.5                        |
|               | 3G3FV-B422K-E   | L1, L2, L3, (-), (+)1, (+)3, T1, T2, T3   | M16            | 325 x 2P                          |
|               |   |  | M8             | 60                                |
| r, s200, s400 |   | M4  | 0.5 to 5.5     |                                   |
| 3G3FV-B430K-E | L1, L2, L3, (-), (+)1, (+)3, T1, T2, T3   | M16   | 325 x 2P       |                                   |
|               |  | M8  | 60             |                                   |
|               | r, s200, s400   | M4  | 0.5 to 5.5     |                                   |

**Note** The wire thickness is set for copper wires at 75°C.

● Round Solderless Terminals and Tightening Torque

| Wire thickness (mm <sup>2</sup> ) | Terminal screw | Size   | Tightening torque (N•m) |
|-----------------------------------|----------------|--------|-------------------------|
| 0.5                               | M4             | 1.25-4 | 1.2                     |
| 0.75                              | M4             | 1.25-4 | 1.2                     |
| 1.25                              | M4             | 1.25-4 | 1.2                     |
| 2                                 | M4             | 2-4    | 1.2                     |
|                                   | M5             | 2-5    | 2.0                     |
|                                   | M6             | 2-6    | 2.5                     |
|                                   | M8             | 2-8    | 6.0                     |
| 3.5/5.5                           | M4             | 5.5-4  | 1.2                     |
|                                   | M5             | 5.5-5  | 2.0                     |
|                                   | M6             | 5.5-6  | 2.5                     |
|                                   | M8             | 5.5-8  | 6.0                     |
| 8                                 | M5             | 8-5    | 2.0                     |
|                                   | M6             | 8-6    | 2.5                     |
|                                   | M8             | 8-8    | 6.0                     |
| 14                                | M6             | 14-6   | 2.5                     |
|                                   | M8             | 14-8   | 6.0                     |
| 22                                | M6             | 22-6   | 2.5                     |
|                                   | M8             | 22-8   | 6.0                     |
| 30/38                             | M8             | 38-8   | 6.0                     |
| 50/60                             | M8             | 60-8   | 6.0                     |
|                                   | M10            | 60-10  | 10.0                    |
| 80                                | M10            | 80-10  | 10.0                    |
| 100                               |                | 100-10 | 10.0                    |
| 100                               | M12            | 100-12 | 14.0                    |
| 150                               |                | 150-12 | 14.0                    |
| 200                               |                | 200-12 | 14.0                    |
| 325                               | M12 x 2        | 325-12 | 14.0                    |
|                                   | M16            | 325-16 | 25.0                    |

**Note Determining Wire Size**

Determine the wire size for the main circuit so that line voltage drop is within 2% of the rated voltage.

Line voltage drop is calculated as follows:

$$\text{Line voltage drop (V)} = \sqrt{3} \times \text{wire resistance } (\Omega/\text{km}) \times \text{wire length (m)} \times \text{current (A)} \times 10^{-3}$$

■ Wiring on the Input Side of Main Circuit

● Installing a Molded-case Circuit Breaker

Always connect the power input terminals (L1, L2, and L3) and power supply via a molded-case circuit breaker (MCCB).

- Choose an MCCB with a capacity of 1.5 to 2 times the Inverter’s rated current.
- For the MCCB’s time characteristics, be sure to consider the Inverter’s overload protection (one minute at 150% of the rated output current).
- If the MCCB is to be used in common among multiple Inverters, or other devices, set up a sequence such that the power supply will be turned off by a fault output, as shown in the following diagram.

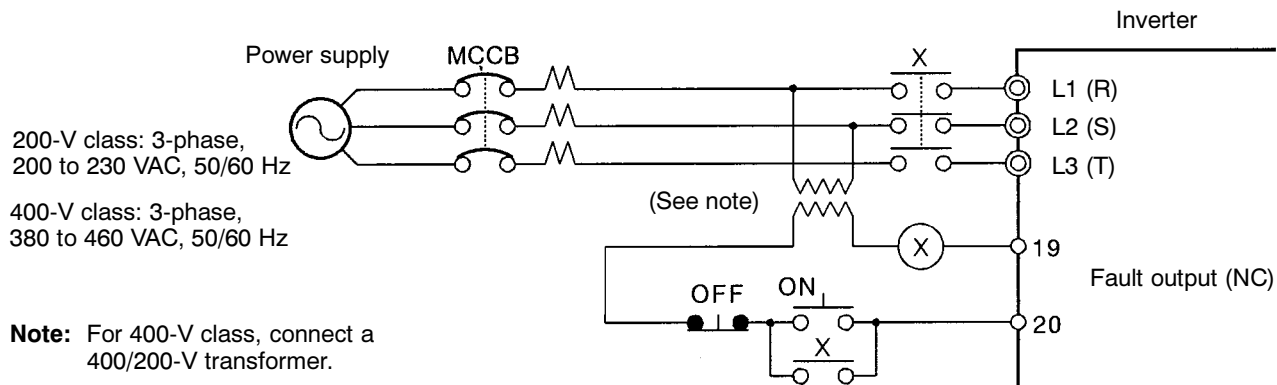

● Installing a Ground Fault Interrupter

Inverter outputs use high-speed switching, so high-frequency leakage current is generated. In general, a leakage current of approximately 100 mA will occur for each Inverter (when the power cable is 1 m), and approximately 5 mA for each additional meter of power cable. Therefore, at the power supply input area, use a special-purpose breaker for Inverters, which detects only the leakage current in the frequency range that is hazardous to humans and excludes high-frequency leakage current.

- For the special-purpose breaker for Inverters, choose a ground fault interrupter with a sensitivity amperage of at least 10 mA per Inverter.
- When using a general leakage breaker, choose a ground fault interrupter with a sensitivity amperage of 200 mA or more per Inverter and with an operating time of 0.1 s or more.

● Installing a Magnetic Contactor

If the power supply for the main circuit is to be shut off because of the sequence, a magnetic contactor can be used instead of a molded-case circuit breaker.

When a magnetic contactor is installed on the primary side of the main circuit to forcibly stop a load, however, the regenerative braking does not work and the load coasts to a stop.

- A load can be started and stopped by opening and closing the magnetic contactor on the primary side. Frequently opening and closing the magnetic contactor, however, may cause the Inverter to break down.
- When the Inverter is operated with the Digital Operator, automatic operation cannot be performed after recovery from a power interruption.
- If the Braking Resistor Unit is to be used, program the sequence so that the magnetic contactor is turned off by the contact of the Unit’s thermal relay.



● **Connecting Input Power Supply to the Terminal Block**

Input power supply can be connected to any terminal on the terminal block because the phase sequence of input power supply is irrelevant to the phase sequence (L1, L2, and L3).

● **Installing an AC Reactor**

If the Inverter is connected to a large-capacity power transformer (600 kW or more) or the phase advance capacitor is switched, an excessive peak current may flow through the input power circuit, causing the converter unit to break down. To prevent this, install an optional AC reactor on the input side of the Inverter. This also improves the power factor on the power supply side.

● **Installing a Surge Absorber**

Always use a surge absorber or diode for the inductive loads near the Inverter. These inductive loads include magnetic contactors, electromagnetic relays, solenoid valves, solenoids, and magnetic brakes.

● **Wiring the Power Terminal of the Inverter with 18.5- to 300-kW Output**

- For 200-V class, 18.5 to 75 kW, or 400-V class, 18.5 to 45 kW, connect the r and s terminals to the L1 (R) and L2 (S) terminals respectively. (These are shorted by short wire for shipping.)
- For 400-V class, 55 to 300 kW, connect the r and s400 terminals to the L1 (R) and L2 (S) terminals respectively. (These are shorted by a short wire for shipping.)

● **Installing a Noise Filter on Power Supply Side**

Install a noise filter to eliminate noise transmitted between the power line and the Inverter.

● **Wiring Example 1**

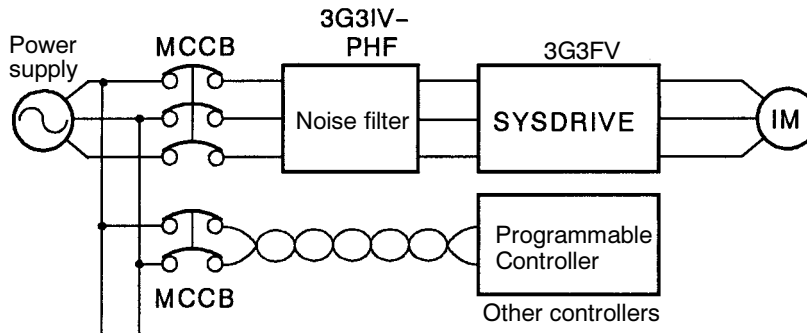

**Note** Use a special-purpose noise filter for Inverters.

- **Wiring Example 2**

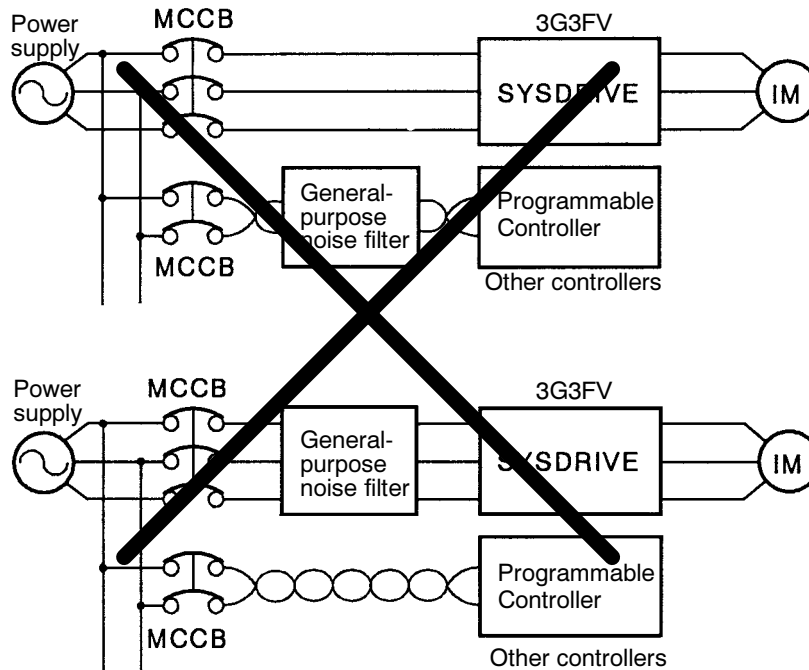

Do not use any general-purpose noise filter. No general-purpose noise filter can effectively suppress noise generated from the Inverter.

## ■ Wiring on the Output Side of Main Circuit

- **Connecting the Terminal Block to the Load**

Connect output terminals T1 (U), T2 (V), and T3 (W) to motor lead wires T1 (U), T2 (V), and T3 (W), respectively. Check that the motor rotates forward with the forward command. Switch over any two of the output terminals to each other and reconnect if the motor rotates in reverse with the forward command.

- **Never Connect a Power Supply to Output Terminals**

Never connect a power supply to output terminals T1 (U), T2 (V), and T3 (W). If voltage is applied to the output terminals, the internal circuit of the Inverter will be damaged.

- **Never Short or Ground Output Terminals**

If the output terminals are touched with bare hands or the output wires come into contact with the Inverter casing, an electric shock or grounding will occur. This is extremely hazardous. Also, be careful not to short the output wires.

- **Do Not Use a Phase Advancing Capacitor or Noise Filter**

Never to connect a phase advance capacitor or LC/RC noise filter to the output circuit. Doing so may result in damage to the Inverter or cause other parts to burn.

- **Do Not Use an Electromagnetic Switch or Magnetic Contactor**

Do not connect an electromagnetic switch or magnetic contactor to the output circuit. If a load is connected to the Inverter during running, an inrush current will actuate the overcurrent protective circuit in the Inverter.

● **Installing a Thermal Relay**

This Inverter has an electronic thermal protection function to protect the motor from overheating. If, however, more than one motor is operated with one Inverter or multi-polar motor is used, always install a thermal relay (THR) between the Inverter and the motor and set n033 to 0 (no thermal protection). In this case, program the sequence so that the magnetic contactor on the input side of the main circuit is turned off by the contact of the thermal relay.

● **Installing a Noise Filter on Output Side**

Connect a noise filter to the output side of the Inverter to reduce radio noise and induction noise.

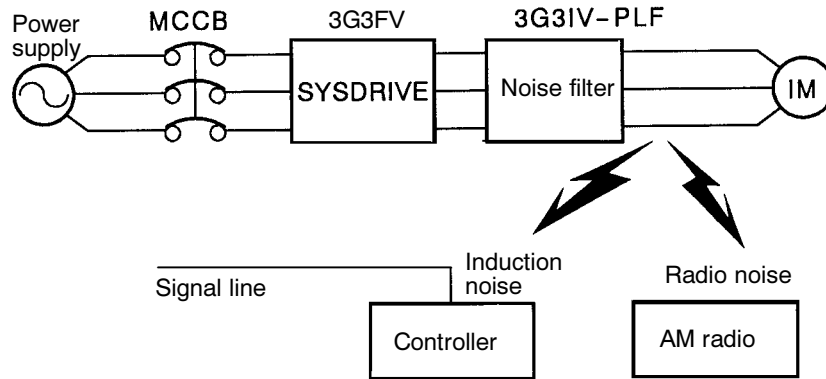

Induction Noise: Electromagnetic induction generates noise on the signal line, causing the controller to malfunction.

Radio Noise: Electromagnetic waves from the Inverter and cables cause the broadcasting radio receiver to make noise.

● **Countermeasures Against Induction Noise**

As described previously, a noise filter can be used to prevent induction noise from being generated on the output side. Alternatively, cables can be routed through a grounded metal pipe to prevent induction noise. Keeping the metal pipe at least 30 cm away from the signal line considerably reduces induction noise.

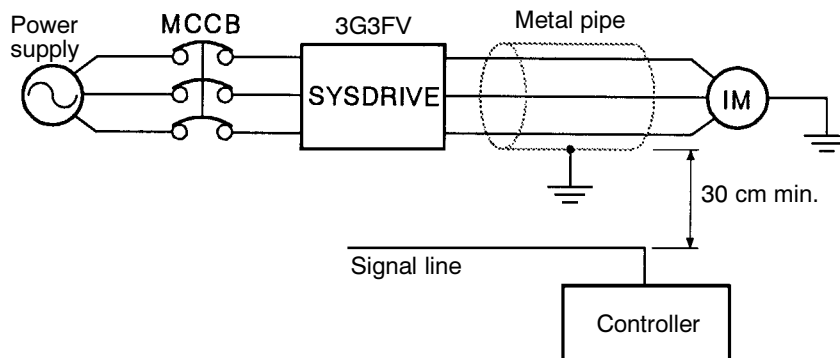

● Countermeasures Against Radio Interference

Radio noise is generated from the Inverter as well as the input and output lines. To reduce radio noise, install noise filters on both input and output sides, and also install the Inverter in a totally enclosed steel box. The cable between the Inverter and the motor should be as short as possible.

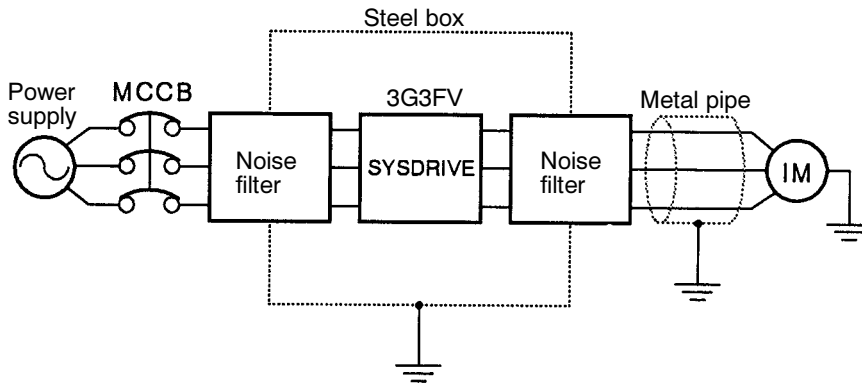

● Cable Length between Inverter and Motor

If the cable between the Inverter and the motor is long, the high-frequency leakage current will increase, causing the Inverter output current to increase as well. This may affect peripheral devices. To prevent this, adjust the carrier frequency (set in C06-01 to C06-03) as shown in the table below. (For details, refer to the parameter settings.)

| Cable length        | 50 m max.   | 100 m max.  | More than 100 m |
|---------------------|-------------|-------------|-----------------|
| Carrier frequency   | 15 kHz max. | 10 kHz max. | 5 kHz max.      |
| (Set value: C06-01) | (15.0)      | (10.0)      | (5.0)           |
| (Set value: C06-02) | (15.0)      | (10.0)      | (5.0)           |
| (Set value: C06-03) | (0)         | (0)         | (0)             |

**Note** The carrier frequency setting range varies depending on the Inverter capacity.

- 200-V class, 18.5 kW max.; 400-V class, 30 kW max.: 0.4 to 15.0 kHz
- 200-V class, 22 to 75 kW; 400-V class, 37 to 160 kW: 0.4 to 10.0 kHz
- 400-V class, 185 to 300 kW: 0.4 to 2.5 kHz

■ **Ground Wiring**

- Always use the ground terminal of the 200-V Inverter with a ground resistance of less than 100 Ω and that of the 400-V Inverter with a ground resistance of less than 10 Ω.
- Do not share the ground wire with other devices such as welding machines or power tools.
- Always use a ground wire that complies with technical standards on electrical equipment and minimize the length of the ground wire.  
Leakage current flows through the Inverter. Therefore, if the distance between the ground electrode and the ground terminal is too long, potential on the ground terminal of the Inverter will become unstable.
- When using more than one Inverter, be careful not to loop the ground wire.

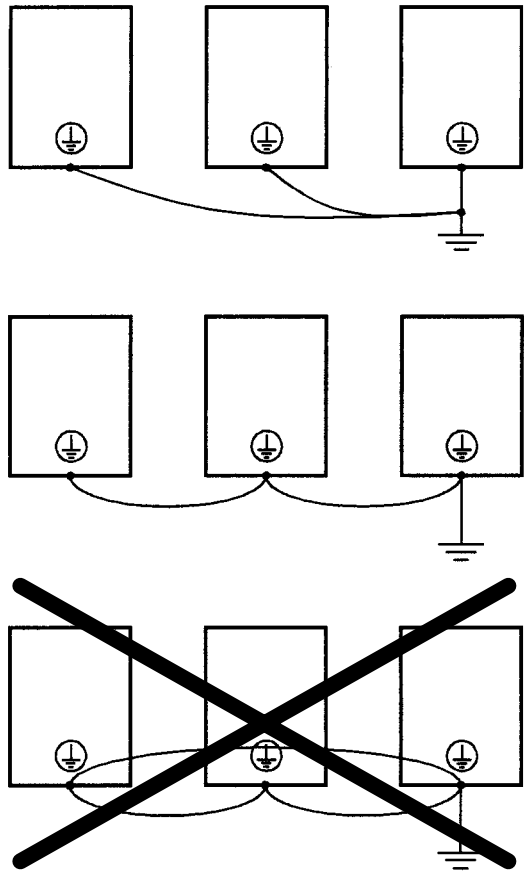

■ Countermeasures against Harmonics

With the continuing development of electronics, the generation of harmonics from industrial machines has been causing problems recently. Refer to the following for the definition of harmonics (i.e., harmonic currents with voltages) and countermeasures against the generation of harmonics from the Inverter.

● Harmonics (Harmonic Currents with Voltages)

• Definition

Harmonics consist of electric power produced from AC power and alternating at frequencies that are integral multiples of the frequency of the AC power.

The following are the harmonic frequencies of a 60- or 50-Hz commercial power supply.

Second harmonic: 120 (100) Hz

Third harmonic: 180 (150) Hz

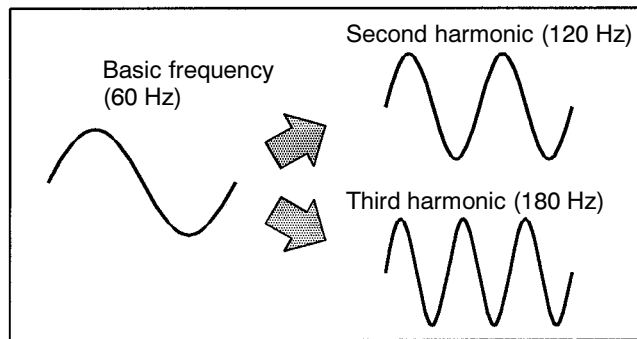

• Problems Caused by Harmonics Generation

The waveform of the commercial power supply will be distorted if the commercial power supply contains excessive harmonics.

Machines with such a commercial power supply will malfunction or generate excessive heat.

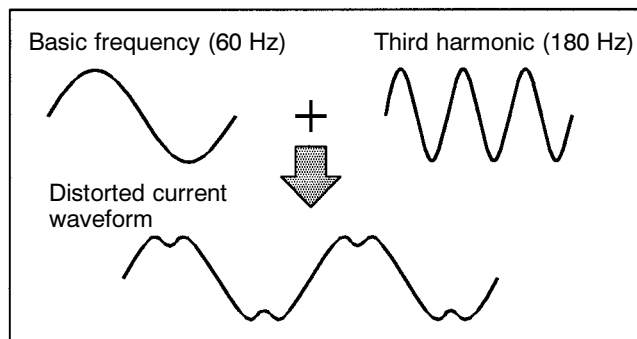

● Causes of Harmonics Generation

• Usually, electric machines have built-in circuitry that converts commercial AC power supply into DC power. Such AC power, however, contains harmonics due to the difference in current flow between AC and DC.

• Obtaining DC from AC using Rectifiers and Capacitors

DC voltage is obtained by converting AC voltage into a pulsating one-side voltage with rectifiers and smoothing the pulsating one-side voltage with capacitors. Such AC current, however, contains harmonics.

• **Inverter**

The Inverter as well as normal electric machines has an input current containing harmonics because the Inverter converts AC into DC.

The output current of the Inverter is comparatively high. Therefore, the ratio of harmonics in the output current of the Inverter is higher than that of any other electric machine.

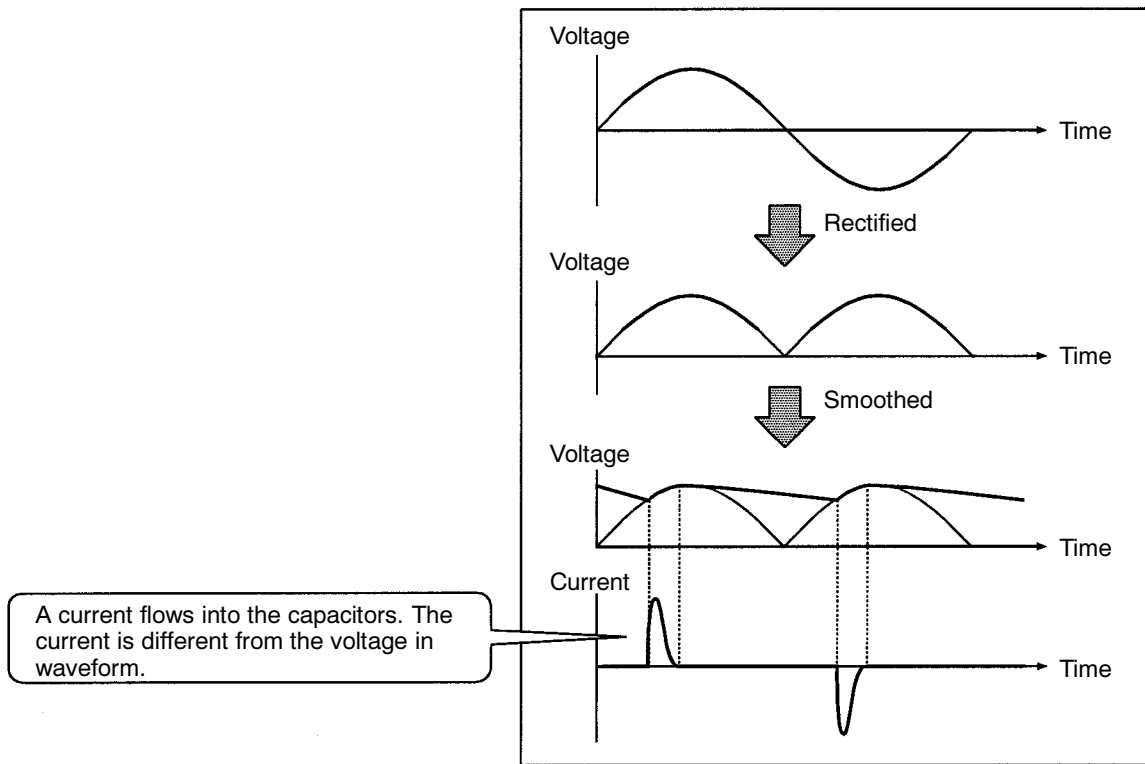

• **Countermeasures with Reactors against Harmonics Generation**

• **DC/AC Reactors**

The DC reactor and AC reactor suppress harmonics and currents that change suddenly and greatly. The DC reactor suppresses harmonics better than the AC reactor. The DC reactor used with the AC reactor suppresses harmonics more effectively.

The input power factor of the Inverter is improved by suppressing the harmonics in the input current of the Inverter.

**Note** 18.5- to 160-kW Inverters have a built-in DC reactor.

185- to 300-kW Inverters cannot use a DC reactor.

• **Connection**

Connect the DC reactor to the internal DC power supply of the Inverter after shutting off the power supply to the Inverter and making sure that the charge indicator of the Inverter turns off.

**⚠ WARNING** Do not touch the internal circuitry of the Inverter in operation, otherwise an electric shock or a burn injury may occur.

• Wiring Method

With DC Reactor

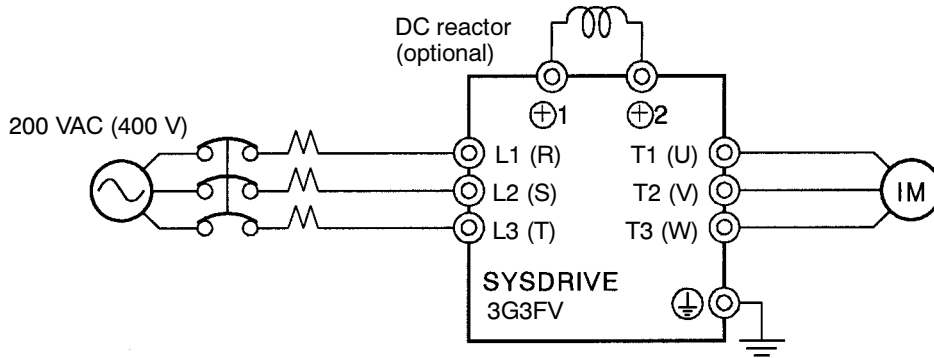

**Note** Be sure to remove the short bar on terminals +1 and +2 before connecting the DC reactor.

With DC and AC Reactors

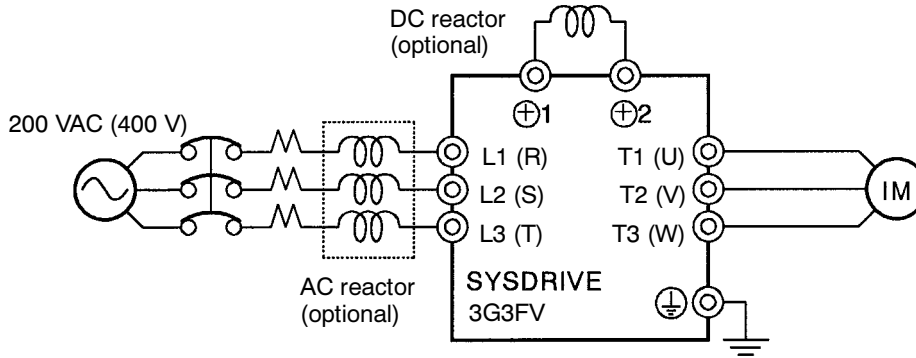

**Note** Be sure to remove the short bar on terminals +1 and +2 before connecting the DC reactor.

• Reactor Effects

Harmonics are effectively suppressed when the DC reactor is used with the AC reactor as shown in the following table.

| Harmonic suppression method | Harmonic generation rate (%) |              |               |               |               |               |               |               |
|-----------------------------|------------------------------|--------------|---------------|---------------|---------------|---------------|---------------|---------------|
|                             | 5th harmonic                 | 7th harmonic | 11th harmonic | 13th harmonic | 17th harmonic | 19th harmonic | 23th harmonic | 25th harmonic |
| No reactor                  | 65                           | 41           | 8.5           | 7.7           | 4.3           | 3.1           | 2.6           | 1.8           |
| AC reactor                  | 38                           | 14.5         | 7.4           | 3.4           | 3.2           | 1.9           | 1.7           | 1.3           |
| DC reactor                  | 30                           | 13           | 8.4           | 5             | 4.7           | 3.2           | 3.0           | 2.2           |
| DC and AC reactors          | 28                           | 9.1          | 7.2           | 4.1           | 3.2           | 2.4           | 1.6           | 1.4           |



■ **Connecting the Braking Resistor**

- Connect the braking resistor as shown in the following diagram.
- When using a Braking Resistor Unit, set L8-01 to “1” (i.e., overheating protection of the braking resistor) and set L3-04 to “0” (i.e., no decelerating stall prevention).

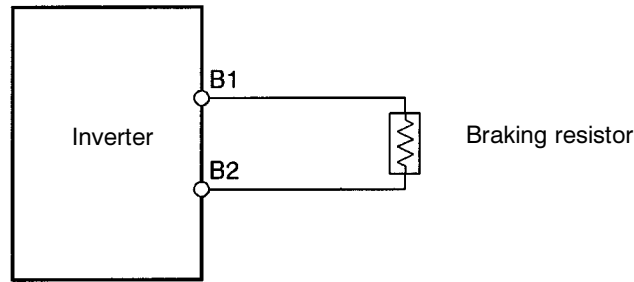

**⚠ Caution** The braking resistor’s connection terminals are B1 and B2. Do not connect any other terminals. Connecting any terminals other than B1 or B2 can cause the resistor to overheat, resulting in damage to the equipment.

■ **Connecting the Braking Resistor Unit and Braking Unit**

- Connect the Braking Resistor Unit and Braking Unit to the Inverter as shown in the following diagrams.
- Set L8-01 to “0” (i.e., no overheating protection of the braking resistor) and L3-04 to “0” (i.e., no decelerating stall prevention) before using the Inverter with the Braking Resistor Unit connected.

**Note 1.** Set L8-01 to “1” before operating the Inverter with the braking resistor without thermal relay trip contacts.

**Note 2.** The Braking Resistor Unit cannot be used and the deceleration time cannot be shortened by the Inverter if L3-04 is set to “1” (i.e., decelerating stall prevention).

- To prevent the Unit from overheating, make a power supply sequence as shown below or connect the thermal relay trip output of the Unit to the external fault input terminal of the Inverter to interrupt the running of the Inverter.

● **200-V Class with 0.4- to 7.5-kW Output and 400-V Class with 0.4- to 15-kW Output**

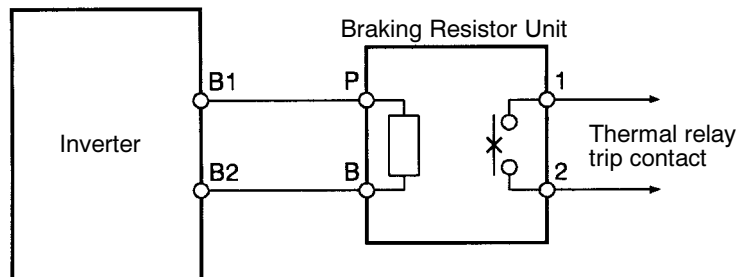

• 200-V Class with 11-kW-or-more Output and 400-V Class with 18.5-or-more Output

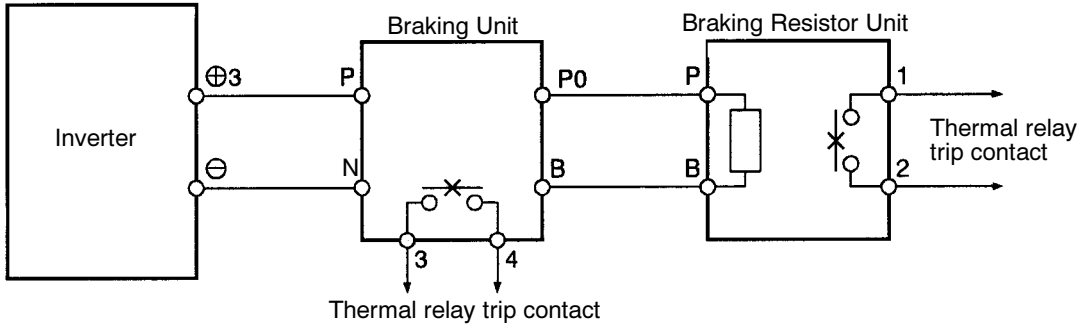

• Connecting Braking Units in Parallel

When connecting two or more Braking Units in parallel, use the wiring and connectors shown in the following diagram. There are connectors for selecting whether each Braking Unit is to be a Master or Slave. Select “Master” for the first Braking Unit only; select “Slave” for all other Braking Units (i.e., from the second Unit onwards).

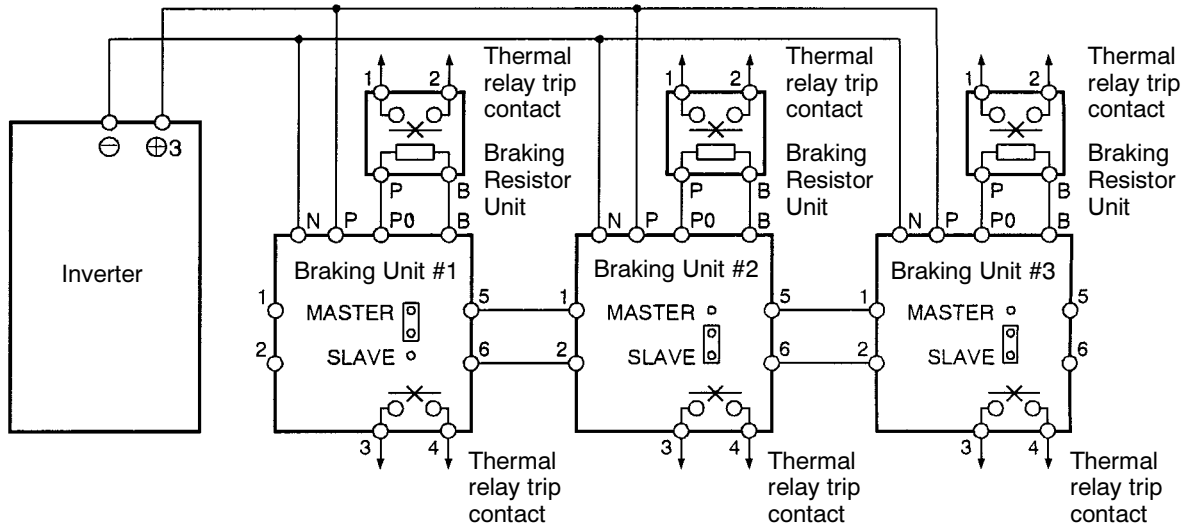

● Power Supply Sequence

200-V class: Three-phase, 200 to 230 VAC (50/60 Hz)  
 400-V class: Three-phase, 380 to 460 VAC (50/60 Hz)

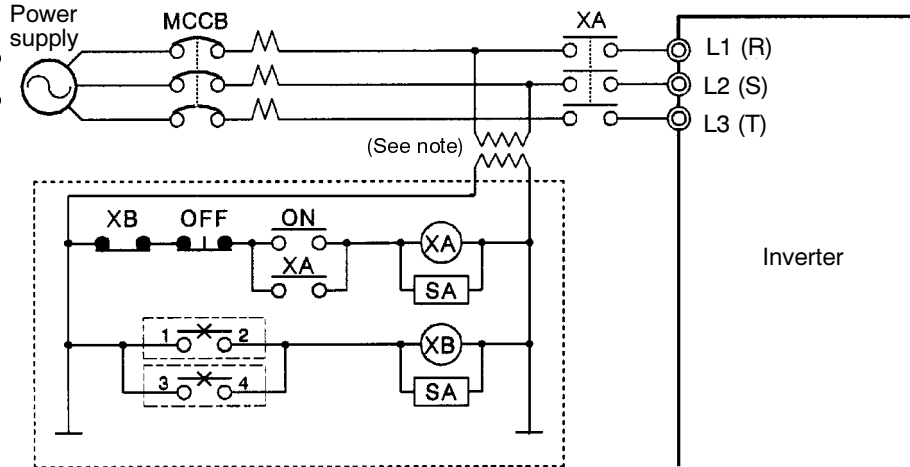

**Note** Use a transformer with 200- and 400-V outputs for the power supply of the 400-V Inverter.

2-2-5 Wiring Control Circuit Terminals

A control signal line must be 50 m maximum and separated from power lines. The frequency reference must be input to the Inverter through twisted-pair wires.

■ Wire Size and Round Solderless Terminals

Use thick wires to prevent voltage drops if the wires are long.

● Wires for All Inverter Models

| Terminal          | Terminal screw | Wire thickness (mm <sup>2</sup> )                      | Type  |
|-------------------|----------------|--|---|
| 1 to 11, 13 to 33 | M3.5           | Stranded wire: 0.5 to 1.25<br>Single wire: 0.5 to 1.25 | Shielded, twisted-pair wire<br>Shielded, polyethylene-covered, vinyl sheath cable |
| 12 (G)            | M3.5           | 0.5 to 2   |   |

● Round Solderless Terminals for Ground Terminal

| Wire thickness (mm <sup>2</sup> ) | Terminal screw | Size        | Screw torque (N • m) |
|-----------------------------------|----------------|-------------|----------------------|
| 0.5                               | M3.5           | 1.25 to 3.5 | 0.8                  |
| 0.75                              |                | 1.25 to 3.5 |                      |
| 1.25                              |                | 1.25 to 3.5 |                      |
| 2                                 |                | 2 to 3.5    |                      |

■ Considerations When Wiring Control Circuit Terminals

- Wire control signal lines separately from the main circuit lines and other power lines.
- Wire control circuit terminals 9, 10, 18, 19, and 20 (contact outputs) separately from terminals 1 to 8, 21, 22, 23, 25, 26, 27, 33, and 11 to 17.
- Connect shielded wire to terminal 12(G).
- Insulate the shielded areas with tape to prevent contact with other signal lines and equipment.

## 2-2-6 Installing and Wiring PG Speed Control Cards

PG Speed Control Cards are used for executing speed control using a pulse generator (PG). There are four types of PG speed control, as shown below. Select the type that fits the application and control method.

3G3FV-PPGA2: A-phase (single) pulse input for open collector output, special-purpose V/f control

3G3FV-PPGB2: A/B-phase pulse input for open collector output, special-purpose vector control

3G3FV-PPGD2: A-phase (single) pulse input, line driver input, special-purpose V/f control

3G3FV-PPGX2: A/B/Z-phase pulse input, line driver input, special-purpose vector control

### ■ Installing a PG Speed Control Card

1. Turn off the main-circuit power supply, and leave it off for at least one minute before removing the front cover of the Inverter (or at least three minutes for Inverters of 30 kW or more). Check to be sure that the CHARGE light is OFF.
2. Insert the spacer (which is provided) into the spacer hole in the Inverter's mounting base. For Inverters of 3.7 kW or less, there are two adjacent holes. Insert the spacer into the 7CN hole. The spacer cannot be easily removed if inserted into the wrong hole. Be very careful to insert the spacer into the correct hole, and in the proper direction.
3. Referring to the enlarged illustration in the following diagram, align the PG Speed Control Card with the catch position as shown by (1) and (2) and fit it precisely to the Option-A connector. Then pass the spacer through the spacer hole at the Card. (Refer to illustration A.) Check to be sure that it is precisely aligned with the 4CN position, and snap it into the proper position.

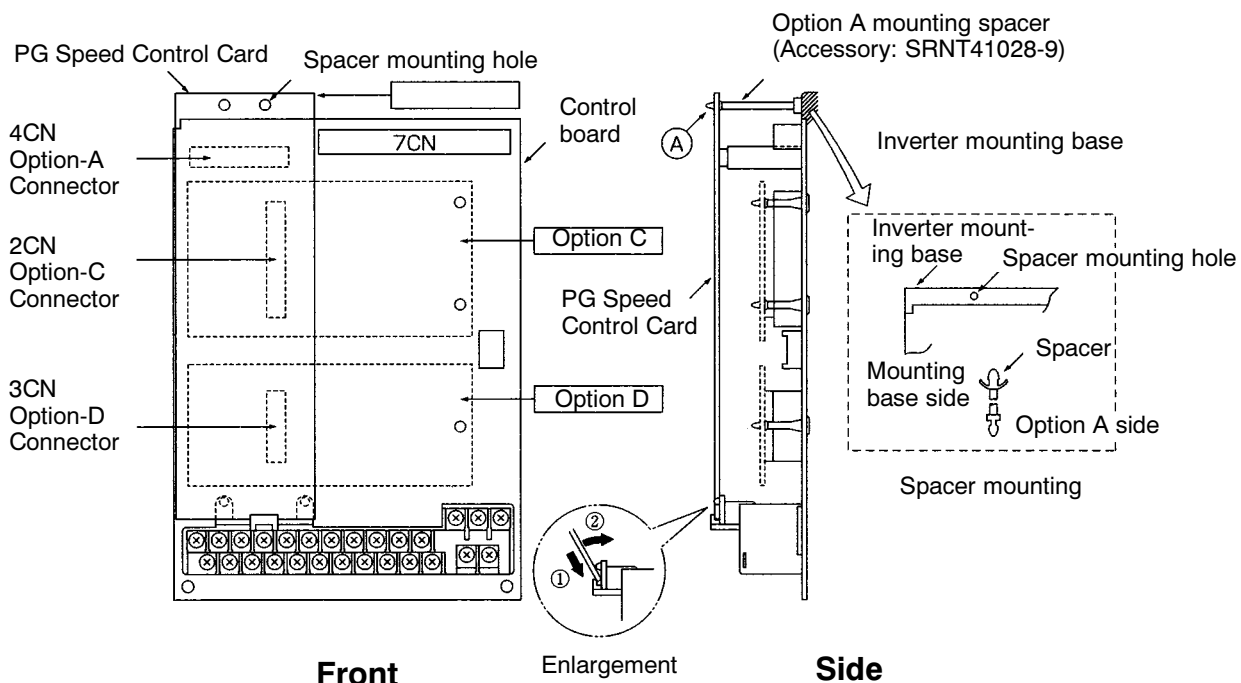

■ PG Speed Control Card Terminal Blocks

● 3G3FV-PPGA2 (For V/f With PG Feedback Mode Only)

| Terminal | No. | Contents                                | Specifications  |
|----------|-----|---|---|
| TA1      | 1   | Power supply for pulse generator        | 12 VDC ( $\pm 5\%$ ), 200 mA max.   |
|          | 2   |   | 0 VDC (GND for power supply)  |
|          | 3   | +12-V/open collector switching terminal | Terminal for switching between 12-V voltage input and open collector input. For open collector input, short across 3 and 4. |
|          | 4   |   |   |
|          | 5   | Pulse input terminal                    | H: +4 to 12 V; L: +1 V max. (Maximum response frequency: 30 kHz)  |
|          | 6   |   | Pulse input common  |
|          | 7   | Pulse motor output terminal             | 12 VDC ( $\pm 10\%$ ), 20 mA max.   |
|          | 8   |   | Pulse monitor output common   |
| TA2      | (E) | Shielded-wire connection terminal       | ---   |

● 3G3FV-PPGB2 (For Flux Vector Control Mode Only)

| Terminal | No. | Contents                          | Specifications   |
|----------|-----|-----------------------------------|--|
| TA1      | 1   | Power supply for pulse generator  | 12 VDC ( $\pm 5\%$ ), 200 mA max.                                |
|          | 2   |                                   | 0 VDC (GND for power supply)                                     |
|          | 3   | A-phase pulse input terminal      | H: +8 to 12 V; L: +1 V max. (Maximum response frequency: 30 kHz) |
|          | 4   |                                   | Pulse input common   |
|          | 5   | B-phase pulse input terminal      | H: +8 to 12 V; L: +1 V max. (Maximum response frequency: 30 kHz) |
|          | 6   |                                   | Pulse input common   |
| TA2      | 1   | A-phase monitor output terminal   | Open collector output, 24 VDC, 30 mA max.                        |
|          | 2   |                                   | A-phase monitor output common                                    |
|          | 3   | B-phase monitor output terminal   | Open collector output, 24 VDC, 30 mA max.                        |
|          | 4   |                                   | B-phase monitor output common                                    |
| TA3      | (E) | Shielded-wire connection terminal | ---  |

● 3G3FV-PPGD2 (For V/f With PG Feedback Mode Only)

| Terminal | No. | Contents                          | Specifications                               |
|----------|-----|-----------------------------------|--|
| TA1      | 1   | Power supply for pulse generator  | 12 VDC ( $\pm 5\%$ ), 200 mA max. (see note) |
|          | 2   |                                   | 0 VDC (GND for power supply)                 |
|          | 3   |                                   | 5 VDC ( $\pm 5\%$ ), 200 mA max. (see note)  |
|          | 4   | Pulse input + terminal            | Line driver input (RS-422 level input)       |
|          | 5   | Pulse input - terminal            | Maximum response frequency: 300 kHz          |
|          | 6   | Common terminal                   | ---  |
|          | 7   | Pulse monitor output + terminal   | Line driver output (RS-422 level output)     |
|          | 8   | Pulse monitor output - terminal   |  |
| TA2      | (E) | Shielded-wire connection terminal | ---  |

**Note** 5 VDC and 12 VDC cannot be used at the same time.

● 3G3FV-PPGX2 (For Flux Vector Control Mode Only)

| Terminal | No. | Contents                         | Specifications  |
|----------|-----|----------------------------------|---|
| TA1      | 1   | Power supply for pulse generator | 12 VDC ( $\pm 5\%$ ), 200 mA max. (see note)                                  |
|          | 2   |                                  | 0 VDC (GND for power supply)  |
|          | 3   |                                  | 5 VDC ( $\pm 5\%$ ), 200 mA max. (see note)                                   |
|          | 4   | A-phase + input terminal         | Line driver input (RS-422 level input)<br>Maximum response frequency: 300 kHz |
|          | 5   | A-phase - input terminal         |   |
|          | 6   | B-phase + input terminal         |   |
|          | 7   | B-phase - input terminal         |   |
|          | 8   | Z-phase + input terminal         |   |
|          | 9   | Z-phase - input terminal         |   |
|          | 10  | Common terminal                  |   |
| TA2      | 1   | A-phase + output terminal        | Line driver output (RS-422 level output)                                      |
|          | 2   | A-phase - output terminal        |   |
|          | 3   | B-phase + output terminal        |   |
|          | 4   | B-phase - output terminal        |   |
|          | 5   | Z-phase + output terminal        |   |
|          | 6   | Z-phase - output terminal        |   |
|          | 7   | Control circuit common           | Control circuit GND   |
| TA3      | (E) |                                  | ---   |

**Note** 5 VDC and 12 VDC cannot be used at the same time.

■ Wiring a PG Speed Control Card

● 3G3FV-PPGA2 (For V/f With PG Feedback Mode Only)

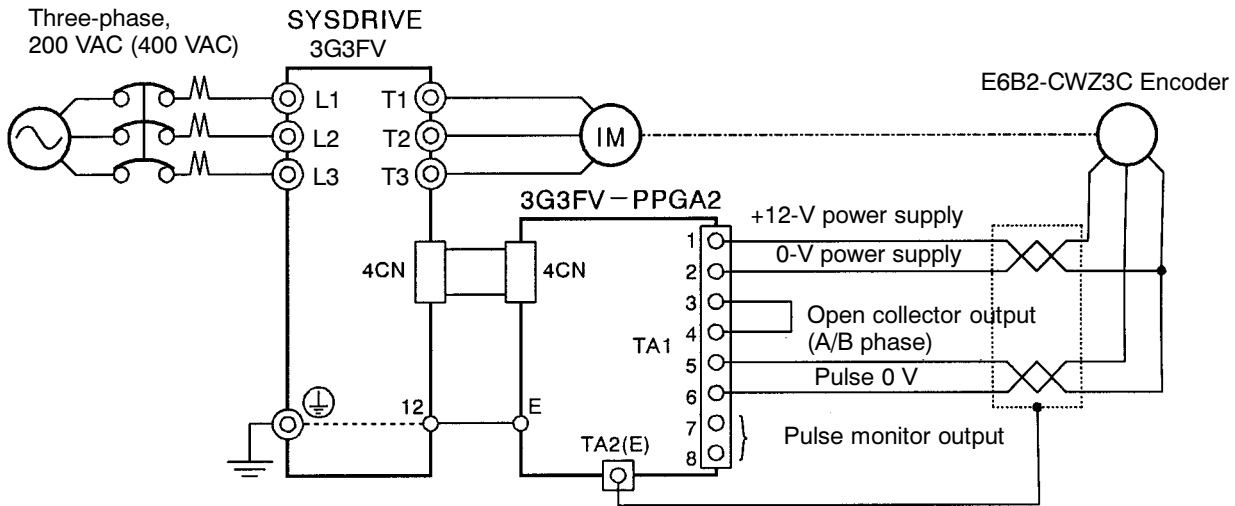
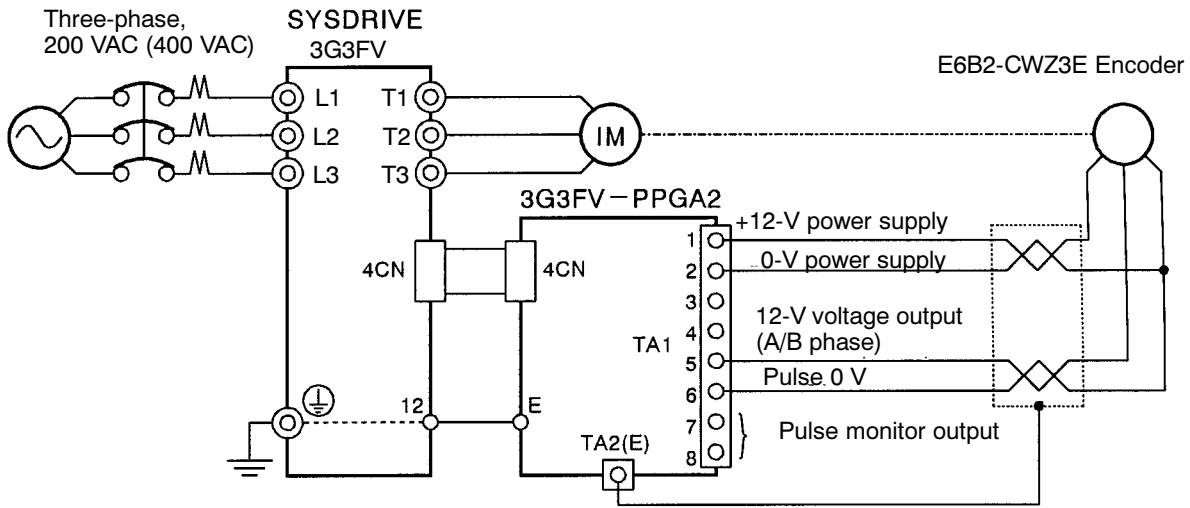

- Note 1.** Twisted-pair shielded wire must be used for signal lines.
- Note 2.** Do not use the pulse generator's power supply for anything other than the pulse generator (encoder). Using it for another purpose can cause malfunctions due to noise.
- Note 3.** The length of the pulse generator's wiring must not be more than 30 meters.

I/O Circuit Configuration

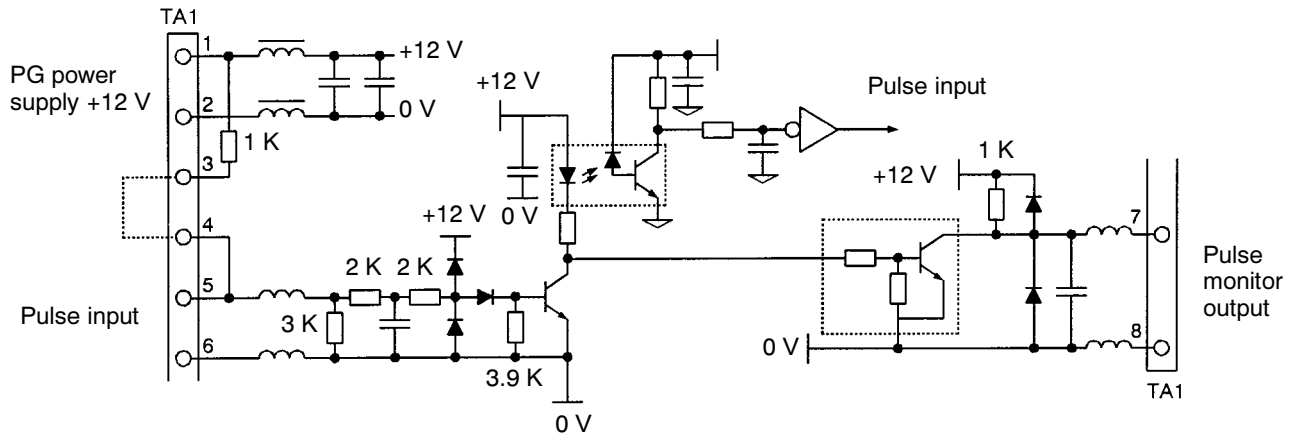

**Note** When connecting to a voltage-output-type PG (encoder), select a PG with an output impedance of no more than 3 kΩ.

• 3G3FV-PPGB2 (For Flux Vector Control Mode Only)

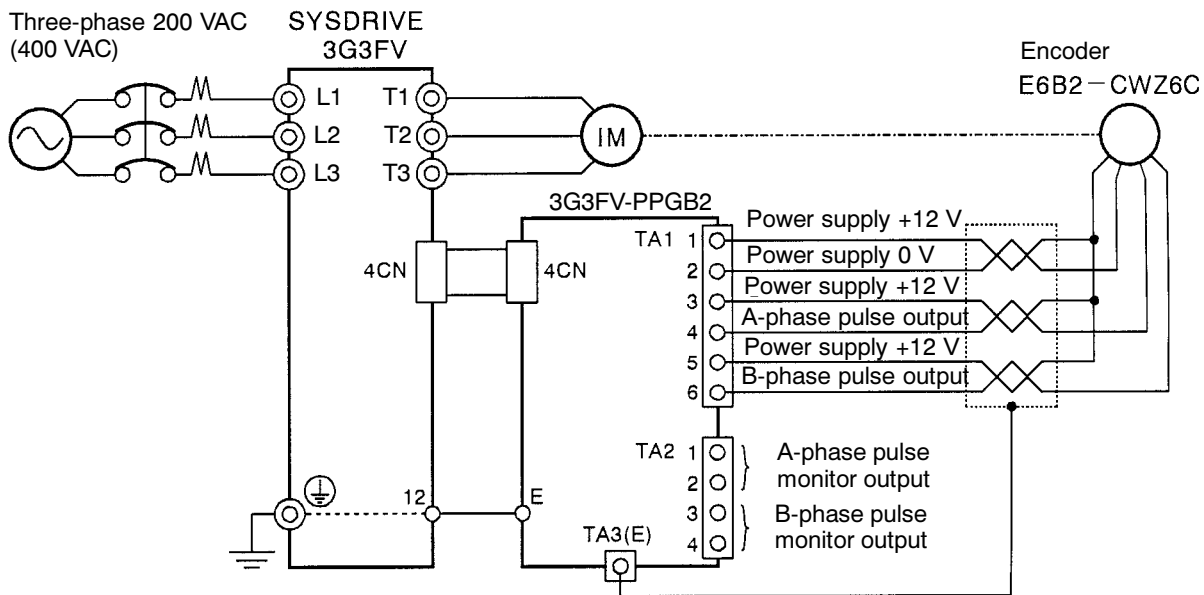

- Note 1.** Twisted-pair shielded wire must be used for signal lines.
- Note 2.** Do not use the pulse generator's power supply for anything other than the pulse generator (encoder). Using it for another purpose can cause malfunctions due to noise.
- Note 3.** The length of the pulse generator's wiring must not be more than 30 meters.



I/O Circuit Configuration

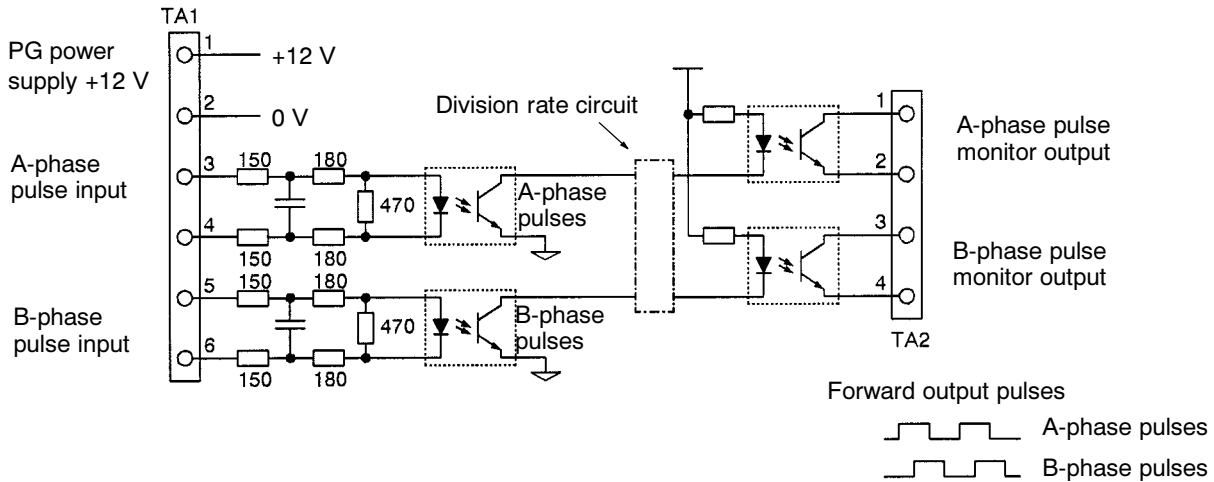

**Note** When connecting to a voltage-output-type PG (encoder), select a PG that has an output impedance with a current of at least 12 mA to the input circuit photocoupler (diode). The E6B2-CWZ3E cannot be used.

• 3G3FV-PPGD2 (For V/f With PG Feedback Mode Only)

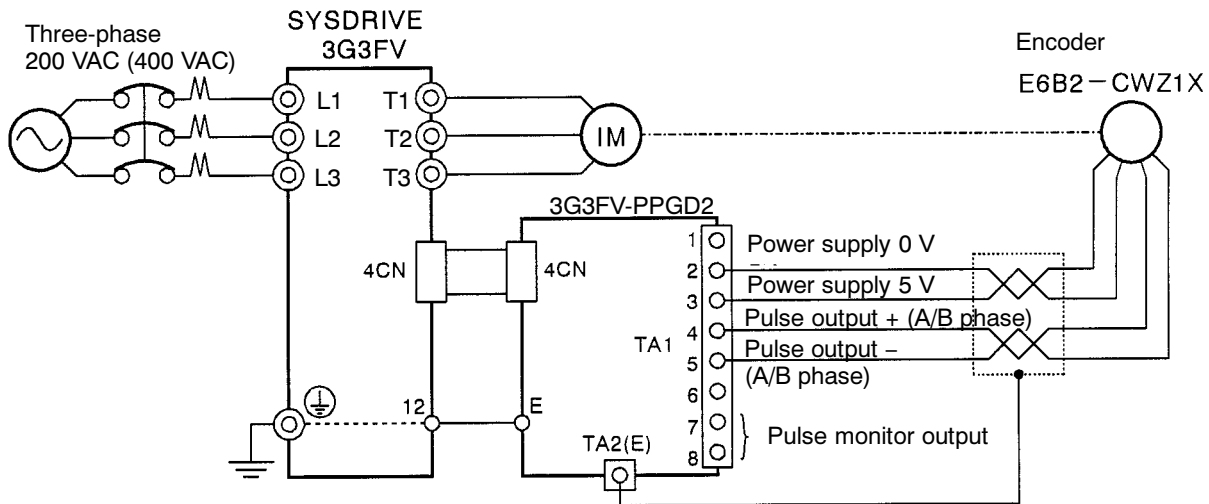

**Note 1.** Twisted-pair shielded wire must be used for signal lines.

**Note 2.** Do not use the pulse generator's power supply for anything other than the pulse generator (encoder). Using it for another purpose can cause malfunctions due to noise.

**Note 3.** The length of the pulse generator's wiring must not be more than 50 meters.

● 3G3FV-PPGX2 (For Flux Vector Control Mode Only)

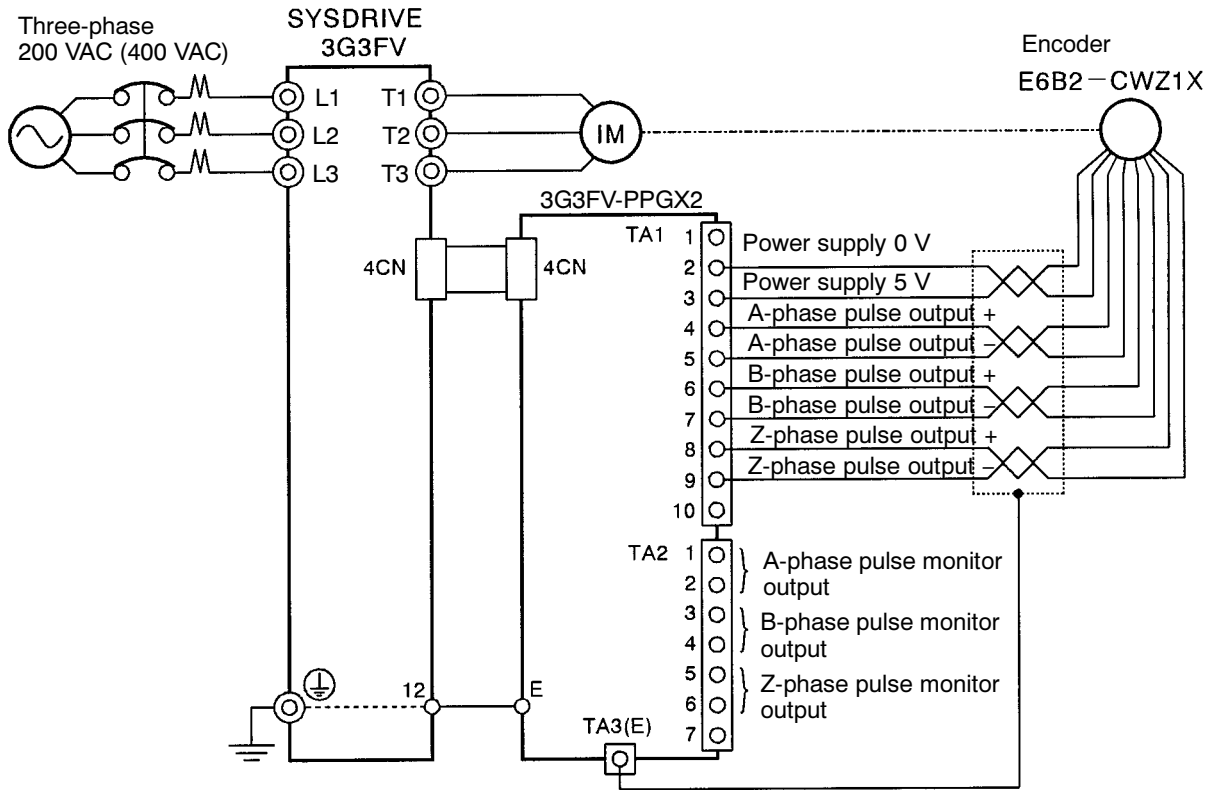

- Note 1.** Shielded, twisted-pair wire must be used for signal lines.
- Note 2.** Do not use the pulse generator's power supply for anything other than the pulse generator (encoder). Using it for another purpose can cause malfunctions due to noise.
- Note 3.** The length of the pulse generator's wiring must not be more than 50 meters.

■ Wiring PG Speed Control Card Terminal Blocks

Use no more than 30 meters of wiring for PG (encoder) signal lines and no more than 50 meters for 3G3FV-PPGD2 and 3G3FV-PPGX2, and keep them separate from power lines. Use shielded, twisted-pair wire for pulse input and pulse output monitor wire, and connect the shield to the shielded wire connection terminal.

● Wires for All Inverter Models

| Terminal                          | Terminal screw | Wire thickness (mm <sup>2</sup> ) | Type  |
|-----------------------------------|----------------|-----------------------------------|---|
| Pulse generator power supply      | ---            | Stranded wire: 0.5 to 1.25        | Shielded, twisted-pair wire<br>Shielded, polyethylene-covered, vinyl sheath cable |
| Pulse input terminal              | ---            | Single wire: 0.5 to 1.25          |   |
| Pulse monitor output terminal     | ---            | ---                               |   |
| Shielded wire connection terminal | M3.5           | 0.5 to 2                          |   |

● **Solderless Terminals for Control Circuit Terminals**

The use of solderless terminals for the control circuit terminals is recommended because solderless terminals are easy to connect securely.

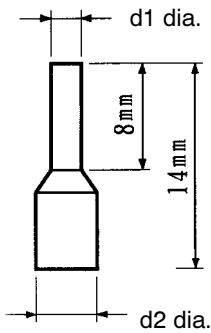

| Wire thickness       | Model       | d1   | d2   | Manufacturer    |
|----------------------|-------------|------|------|-----------------|
| 0.5 mm <sup>2</sup>  | A1 0.5-8WH  | 1.00 | 2.60 | Phoenix Contact |
| 0.75 mm <sup>2</sup> | A1 0.75-8GY | 1.20 | 2.80 |                 |
| 1 mm <sup>2</sup>    | A1 1-8RD    | 1.40 | 3.00 |                 |
| 1.5 mm <sup>2</sup>  | A1 1.5-8BK  | 1.70 | 3.50 |                 |

**Note** Do not solder wires with the control circuit terminals if wires are used instead of solderless terminals. Wires may not contact well with the control circuit terminals or the wires may be disconnected from the control circuit terminals due to vibration if the wires are soldered.

● **Round Solderless Terminal Sizes and Screw Torque**

| Wire thickness (mm <sup>2</sup> ) | Terminal screw | Size        | Screw torque (N • m) |
|-----------------------------------|----------------|-------------|----------------------|
| 0.5                               | M3.5           | 1.25 to 3.5 | 0.8                  |
| 0.75                              |                | 1.25 to 3.5 |                      |
| 1.25                              |                | 1.25 to 3.5 |                      |
| 2                                 |                | 2 to 3.5    |                      |

■ **Wiring Control Circuit Terminals**

● **Wiring Method**

1. Loosen the terminal screws with a thin-slotted screwdriver.
2. Insert the wires from underneath the terminal block.
3. Tighten the terminal screws firmly.

**Note 1.** Always separate the control signal line from the main circuit cables and other power cables.

**Note 2.** Do not solder the wires to the control circuit terminals. The wires may not contact well with the control circuit terminals if the wires are soldered.

**Note 3.** The end of each wire connected to the control circuit terminals must be stripped for approximately 7 mm.

**Note 4.** Use a shielded wire for the ground terminal.

**Note 5.** Insulate the shield with tape so that the shield will not touch any signal line or device.

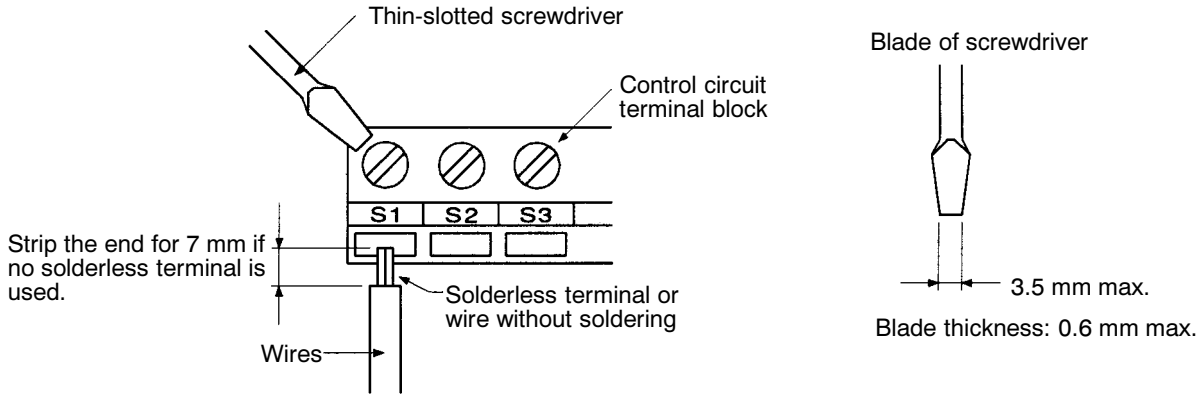

## ■ Selecting the Number of PG (Encoder) Pulses

### ● 3G3FV-PPGA2/-PPGB2

- The maximum response frequency is 30 kHz.
- Taking into consideration the encoder pulse deviation (phase difference:  $90 \pm 45^\circ$ ) and the waveform when the cable is long, select a smaller number of pulses than the ones shown in the following table.

| Motor's maximum speed (r/min)   | 1,800 | 1,500 | 900  |
|---------------------------------|-------|-------|------|
| Number of encoder pulses (p/r)  | 500   | 600   | 1,00 |
| Maximum encoder frequency (kHz) | 15    | 15    | 15   |

### ● 3G3FV-PPGD2/-PPGX2

- The maximum response frequency is 300 kHz.
- When the encoder pulse deviation (phase difference:  $90 \pm 45^\circ$ ) is taken into consideration, the number of encoder pulses can be calculated by means of the following formula:

$$\text{Number of encoder pulses [p/r]} \leq \frac{60 \times \text{maximum response frequency (300,000 Hz)}}{2 \times \text{motor's maximum rotation speed (r/min)}}$$

- If the motor's maximum speed is less than 4,000 r/min, an encoder of 1,000 to 2,000 p/r is recommended. Even if an encoder with higher than required resolution is selected, it will not improve the speed control range or precision.

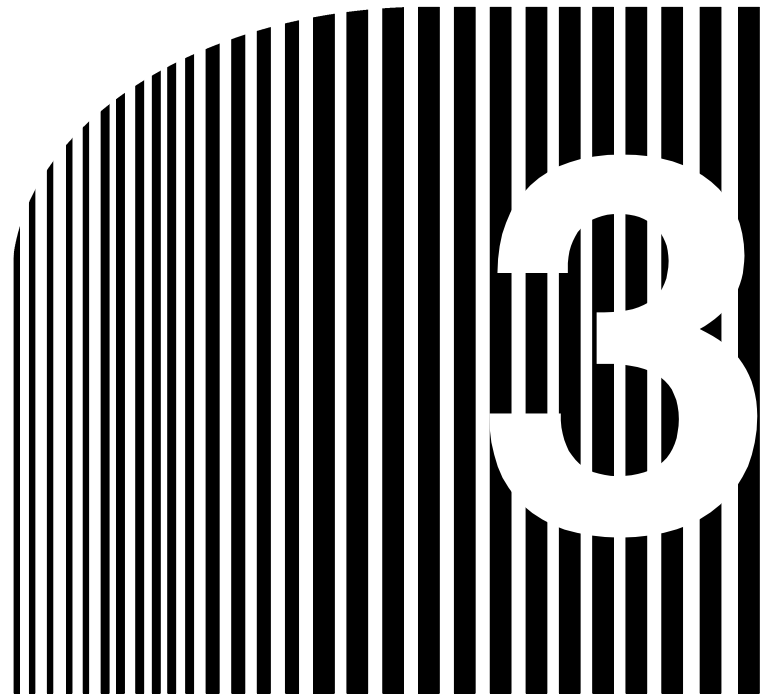

## Chapter 3

### • Preparing for Operation •

- 3-1 Using the Digital Operator
- 3-2 Modes
- 3-3 Operation Mode
- 3-4 Initialize Mode
- 3-5 Program Mode
- 3-6 Auto-tuning Mode
- 3-7 Modified Constants Mode

### 3-1 Using the Digital Operator

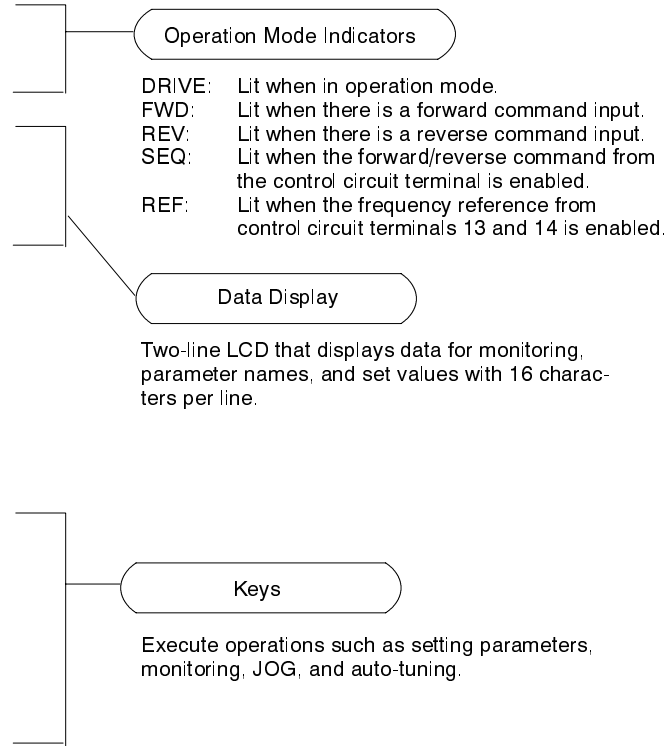
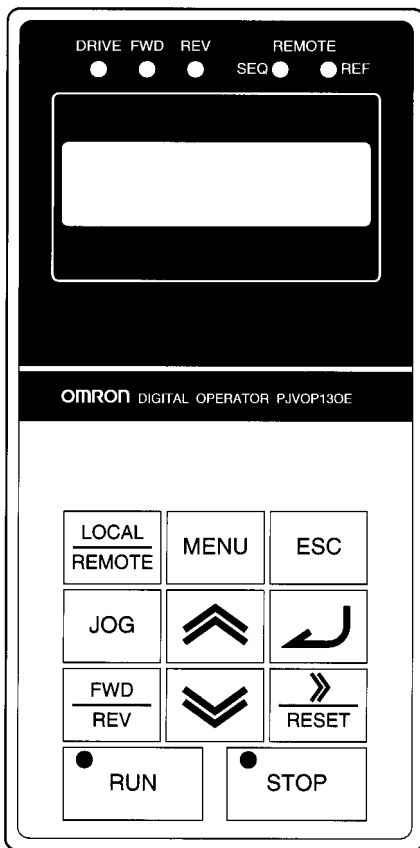

| Key | Name                                   | Function   |
|-----|--|--|
|     | Operation Mode Selection Key           | Switches between Operator and parameter setting (run command and frequency reference). This key can be enabled or disabled with a parameter setting (o2-02). |
|     | Menu Key                               | Displays each mode.  |
|     | Escape Key                             | Returns to the status before the Enter Key is pressed.   |
|     | Jog Key                                | Enables JOG operation when the 3G3FV is in operation with the Digital Operator.  |
|     | Forward/Reverse Rotation Selection Key | Selects the rotation direction of the motor when the 3G3FV is in operation with the Digital Operator.  |
|     | Reset/Digit Selection Key              | Selects digits for parameter settings. Also acts as the reset key when an fault has occurred.  |
|     | Increment Key                          | Selects modes, groups, functions, parameter names, and set values. This key increases numbers when pressed.  |
|     | Decrement Key                          | Selects modes, groups, functions, parameter names, and set values. This key decreases numbers when pressed.  |
|     | Enter Key                              | Enters modes, functions, constants, and set values after they are set.   |
|     | Run Key                                | Starts the 3G3FV running when the 3G3FV is in operation with the Digital Operator.   |
|     | Stop Key                               | Stops the 3G3FV running. This key can be enabled or disabled with a parameter setting (o2-02) in operation with the control circuit terminal.                |

**3-2 Modes**

This section describes the 3G3FV's various parameter setting and monitoring modes.

**■ Inverter Modes**

- The SYSDRIVE 3G3FV Inverter's parameters and monitoring functions have been organized in groups, so it is easier to make settings and read data. These function groups are known as modes.
- The 3G3FV is equipped with 5 modes, as shown in the following table.

| Mode                    | Primary function(s)   |
|-------------------------|---|
| Operation mode          | The Inverter can be run in this mode.<br>Use this mode when monitoring values such as frequency references or output current, displaying fault information, or displaying the fault history.  |
| Initialize mode         | Use this mode when selecting the language displayed on the Digital Operator, selecting the access level for setting/reading parameters, selecting the control mode, or initializing the parameters.   |
| Program mode            | Use this mode when setting/reading the parameters required for operation. The program-mode functions are subdivided into the following groups:<br>Application: Operation mode selection, DC control, speed search, etc.<br>Tuning: Acceleration/deceleration times, S-curve characteristics, carrier frequencies, etc.<br>Reference: Settings related to frequency control<br>Motor: V/f characteristics and Motor constants<br>Option: Settings for Optional Cards<br>Terminal: Settings for sequential I/O and analog I/O<br>Protection: Settings for the motor and inverter protection functions<br>Operator: Selects the Digital Operator's display and key functions |
| Auto-tuning mode        | (Usable only with the vector control mode)<br>Use this mode when running a motor with unknown motor constants in the vector control mode. The motor constants are calculated and set automatically.   |
| Modified constants mode | Use this mode to set/read parameters that have been changed from their factory-set values.  |

**■ Switching Modes**

- Once the Unit has been put into operation mode by pressing the Menu Key, the Increment and Decrement Keys can be pressed to switch to other modes.
- Press the Enter Key to set/read the parameters in each mode.

- Press the Escape Key to return to the mode display from the parameter display.

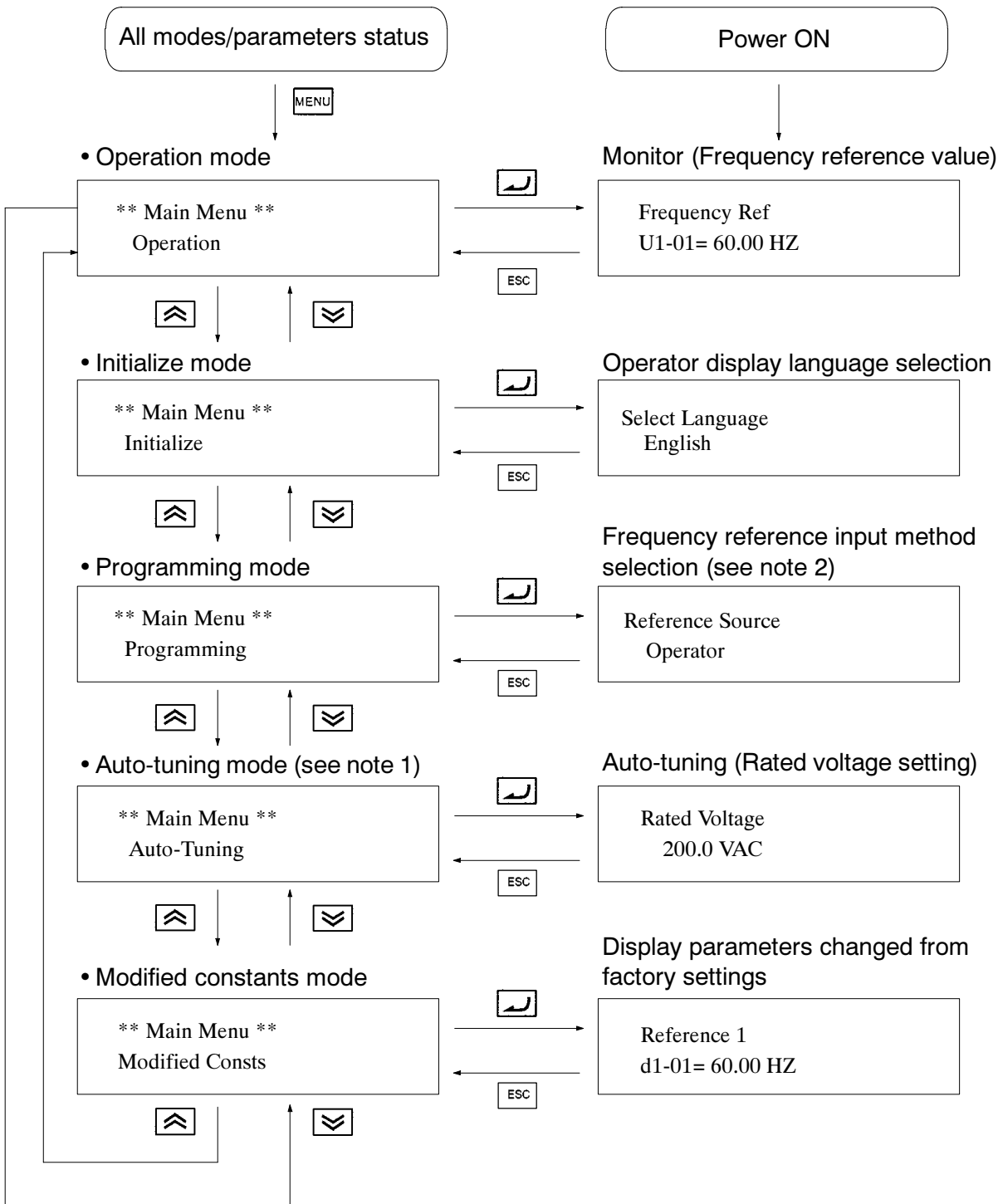

**Note 1.** Auto-tuning mode will be displayed only when vector control mode has been selected. (The factory setting is “vector control without pulse generator.”)

**Note 2.** The actual display depends on the parameter access level setting (A1-01).









■ **Parameter Access Level**

The SYSDRIVE 3G3FV's has three access levels which divide the various parameters based on their usage, as shown below. The access level restricts which parameters can be set or displayed.

| Level       | Function   |
|-------------|--|
| Quick-start | Allows setting/reading of parameters required for test runs. (factory-set) |
| Basic       | Allows setting/reading of general-purpose parameters.                      |
| Advanced    | Allows setting/reading of all parameters.                                  |

Set the access level in initialize mode with parameter A1-01.

● **Changing the Access Level from Quick-start to Basic**

| Key sequence  | Display                       | Explanation                                    |
|---|-------------------------------|--|
|    | ** Main Menu **<br>Operation  | Displays operation mode.                       |
|    | ** Main Menu **<br>Initialize | Displays initialize mode.                      |
|    | Select Language<br>English    | Puts the Unit in initialize mode.              |
|    | Access Level<br>Quick Start   | Switches to the access level parameter.        |
|    | A1-01= 2 ***<br>Quick Start   | Displays the access level parameter setting.   |
|    | A1-01= 3<br>Basic Level       | Changes the access level setting to "BASIC."   |
|  | Entry Accepted                | Writes the new parameter setting.              |
|   | Access Level<br>Basic Level   | Returns to the access level parameter display. |

The following diagram shows this procedure in flowchart format.

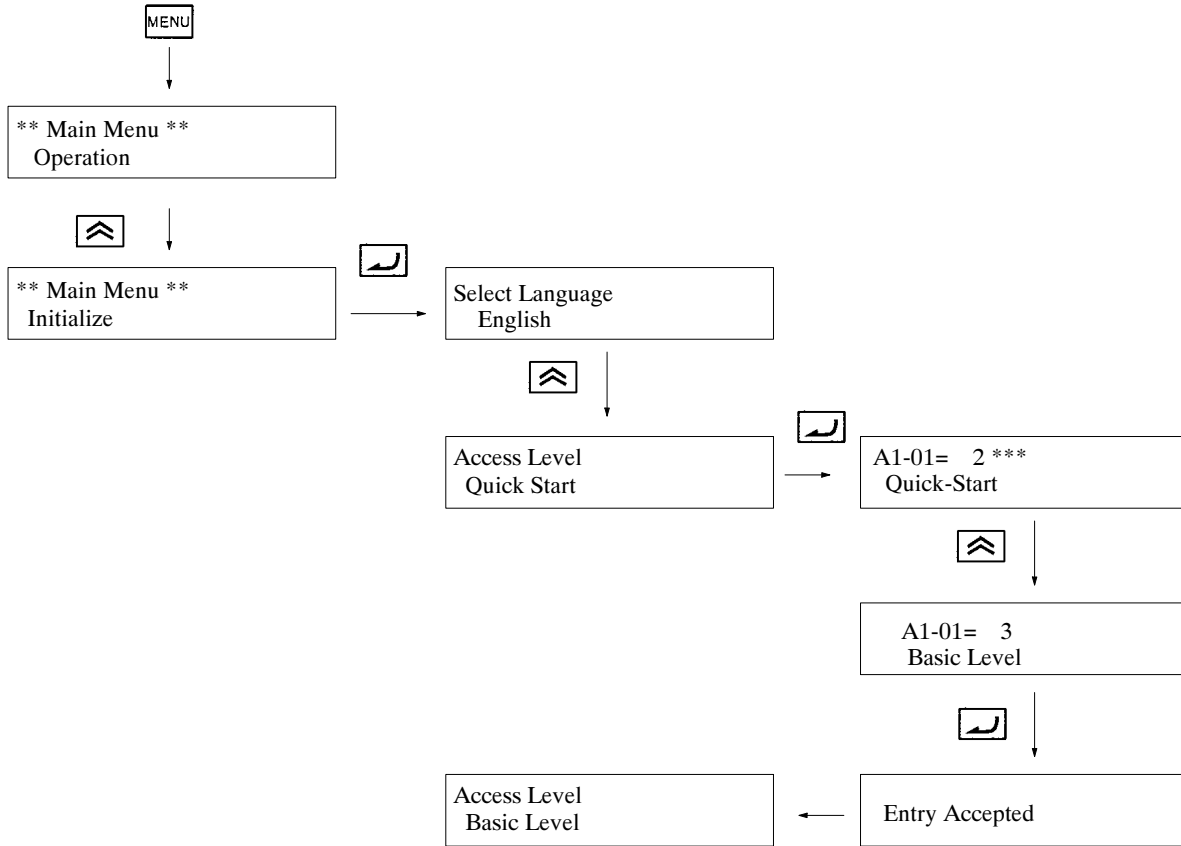

■ **Setting Parameters in Each Access Level**

- The displays in program mode differ for each access level. (There is no difference in other modes.)
- This section provides the procedure to change the acceleration time to 20 s in each access level. The acceleration time (C1-01) is a parameter in program mode.
- If the new parameter setting is not written to the Unit (by pressing the Enter Key) within one minute after starting the procedure, the display will automatically revert to the original parameter setting. In this case, the procedure must be started again.

● Parameter Setting Levels (Partial)

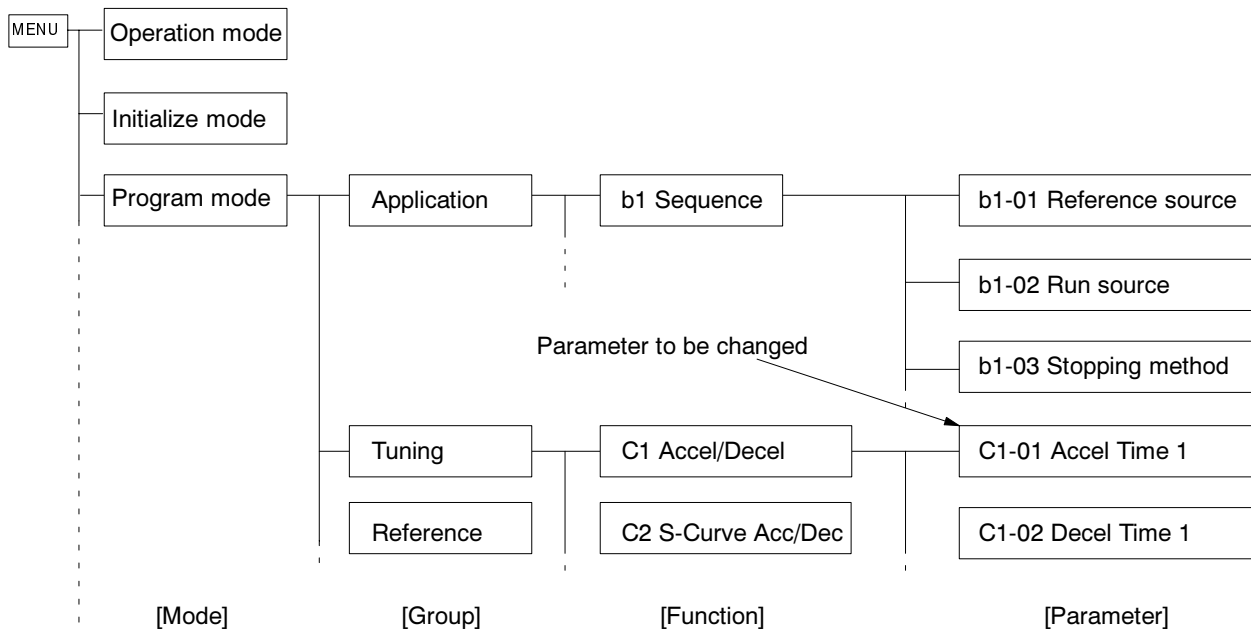











● Setting the Parameter in the Quick-start Access Level

The parameter level will be displayed when the Enter Key is pressed at the program mode display.

| Key sequence    | Display                         | Explanation  |
|-----------------|---------------------------------|--|
| MENU            | ** Main Menu **<br>Operation    | Displays operation mode.   |
| ⏴ 2 times       | ** Main Menu **<br>Programming  | Displays program mode.   |
| ↵               | Reference Source<br>Terminals   | Puts the Unit in program mode.<br>Displays the b1-01 Reference source selection.                 |
| ⏴               | Run Source<br>Terminals         | Displays the b1-02 Run source selection.   |
| ⏴               | Stopping Method<br>Ramp to Stop | Displays the b1-03 Stopping method selection.  |
| ⏴               | Accel Time 1<br>c1-01= 10.0 Sec | Displays C1-01 Acceleration time 1.  |
| ↵               | Accel Time 1<br>0010.0 Sec      | Selects the parameter so that the leading 0 flashes.<br>(The digit that can be changed flashes.) |
| ⏴ RESET 2 times | Accel Time 1<br>0010.0 Sec      | Moves the cursor so that the "1" digit flashes.  |
| ⏴               | Accel Time 1<br>0020.0 Sec      | Changes the 1 to a 2.  |
| ↵               | Entry Accepted                  | Writes the new setting.  |
| ---             | Accel Time 1<br>c1-01= 20.0 Sec | Returns to the C1-01 Acceleration time 1 display.  |
| ESC             | ** Main Menu **<br>Programming  | Returns to the program mode display.   |











● **Setting the Parameter in the Basic Access Level**

The function level will be displayed when the Enter Key is pressed at the program mode display.

| Key sequence  | Display                         | Explanation  |
|---|---------------------------------|--|
|  MENU    | ** Main Menu **<br>Operation    | Displays operation mode.   |
|  2 times | ** Main Menu **<br>Programming  | Displays program mode.   |
|          | Function b1<br>Sequence         | Puts the Unit in program mode.<br>Displays the b1 Sequence function selection.                   |
|          | Function b2<br>DC Braking       | Displays the b2 DC Braking function selection.   |
|          | Function C1<br>Accel/Decel      | Displays the C1 Accel/Decel function selection.  |
|          | Accel Time 1<br>c1-01= 10.0 Sec | Displays C1-01 Acceleration time 1.  |
|          | Accel Time 1<br>0010.0 Sec      | Selects the parameter so that the leading 0 flashes.<br>(The digit that can be changed flashes.) |
|  2 times | Accel Time 1<br>0010.0 Sec      | Moves the cursor so that the "1" digit flashes.  |
|          | Accel Time 1<br>0020.0 Sec      | Changes the 1 to a 2.  |
|          | Entry Accepted                  | Writes the new setting.  |
| ---   | Accel Time 1<br>c1-01= 20.0 Sec | Returns to the C1-01 Acceleration time 1 display.  |
|  ESC   | Function C1<br>Accel/Decel      | Returns to the program mode display.   |

● **Setting the Parameter in the Advanced Access Level**

The group level will be displayed when the Enter Key is pressed at the program mode display.

| Key sequence  | Display                         | Explanation  |
|---|---------------------------------|--|
|  MENU    | ** Main Menu **<br>Operation    | Displays operation mode.   |
|  2 times | ** Main Menu **<br>Programming  | Displays program mode.   |
|          | Group b<br>Application          | Puts the Unit in program mode.<br>Displays the Group b Application group selection.              |
|          | Group C<br>Tuning               | Displays the Group C Tuning group selection.   |
|          | Function C1<br>Accel/Decel      | Displays the C1 Accel/Decel function selection.  |
|          | Accel Time 1<br>c1-01= 10.0 Sec | Displays C1-01 Acceleration time 1.  |
|          | Accel Time 1<br>0010.0 Sec      | Selects the parameter so that the leading 0 flashes.<br>(The digit that can be changed flashes.) |
|  2 times | Accel Time 1<br>0010.0 Sec      | Moves the cursor so that the "1" digit flashes.  |
|          | Accel Time 1<br>0020.0 Sec      | Changes the 1 to a 2.  |
|          | Entry Accepted                  | Writes the new setting.  |
| ---   | Accel Time 1<br>c1-01= 20.0 Sec | Returns to the C1-01 Acceleration time 1 display.  |
|  ESC   | Function C1<br>Accel/Decel      | Returns to the C1 Accel/Decel function selection.  |

**3-3 Operation Mode**

---

---

---

Operation mode is the mode in which the Inverter can run. When running the Inverter, press the Enter Key from the operation mode display to bring up the monitor display. Run commands can't be received from any other display. Once the Unit is running, it can be switched to other modes.

Many parameters can't be changed when the Inverter is running. Refer to *Chapter 7 Parameter Lists* for details.

Bring up monitor displays such as the frequency reference, output frequency, output current, and output voltage as well as fault information and the fault history in operation mode.

---

---

■ Operations in Operation Mode

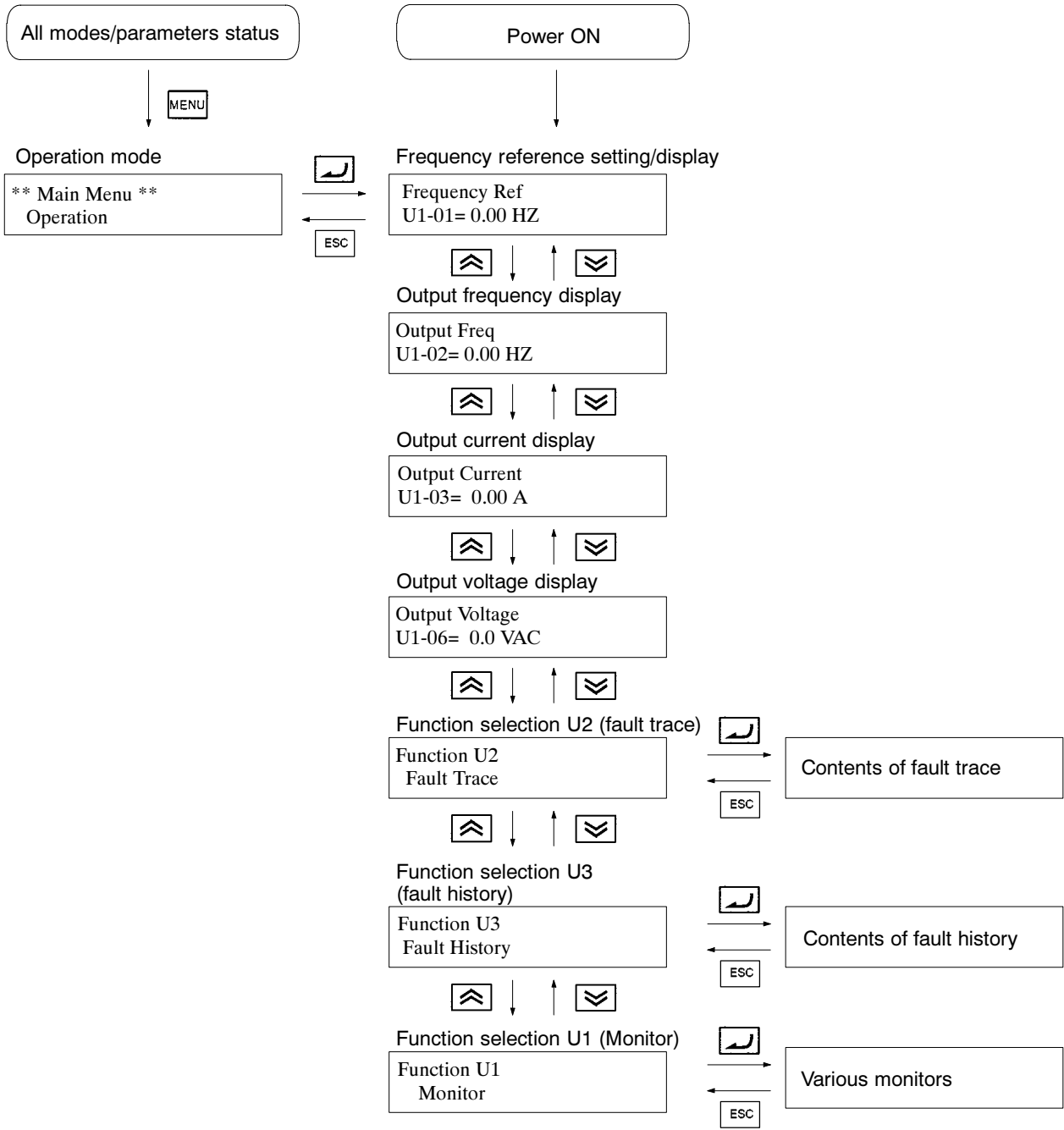

■ **Conditions for Monitoring**

The following tables show the items that can be monitored in operation mode. The table's "Valid access levels" column indicates whether an item can be monitored in a particular access level and control mode. The codes in this column have the following meanings.

Q: These items can be monitored in all access levels. (Quick-start, Basic, and Advanced)

B: These items can be monitored in the Basic and Advanced access levels.

A: These items can be monitored in the Advanced access level only.

X: These items cannot be monitored in the control mode shown.

The output signal levels for multi-function analog outputs shown in the table are for a gain of 100.0 and a bias of 0.00.

**Status Monitor**

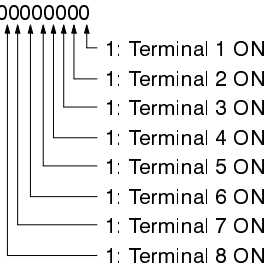
| Item  | Display                                   | Function  | Output signal levels for multi-function analog outputs | Min. Units | Valid access levels |          |             |             |
|-------|---|---|--|------------|---------------------|----------|-------------|-------------|
|       |   |   |  |            | V/f                 | V/f w/PG | Open Vector | Flux Vector |
| U1-01 | Frequency Ref                             | Monitors/sets the frequency reference value.<br>The display units can be set with parameter o1-01.  | 10 V:<br>Max. frequency<br>(0 to ±10 V possible)       | 0.01 Hz    | Q                   | Q        | Q           | Q           |
| U1-02 | Output Freq                               | Monitors the output frequency.<br>The display units can be set with parameter o1-01.  | 10 V:<br>Max. frequency<br>(0 to ±10 V possible)       | 0.01 Hz    | Q                   | Q        | Q           | Q           |
| U1-03 | Output Current                            | Monitors the output current.  | 10 V: Rated current<br>(0 to +10 V output)             | 0.1 A      | Q                   | Q        | Q           | Q           |
| U1-04 | Control Method                            | Shows which control mode is set.  | Can't be output.                                       | ---        | Q                   | Q        | Q           | Q           |
| U1-05 | Motor Speed                               | Monitors the motor speed.   | 10 V:<br>Max. frequency<br>(0 to ±10 V possible)       | 0.01 Hz    | X                   | Q        | Q           | Q           |
| U1-06 | Output Voltage                            | Monitors the Inverter's internal output voltage reference value.  | 10 V: 200 (400) VAC<br>(0 to +10 V output)             | 0.1 V      | Q                   | Q        | Q           | Q           |
| U1-07 | DC Bus Voltage                            | Monitors the DC voltage of the Inverter's internal main circuit.  | 10 V: 400 (800) VDC<br>(0 to +10 V output)             | 1 V        | Q                   | Q        | Q           | Q           |
| U1-08 | Output kWatts                             | Monitors the output power. (This is an internally detected value.)  | 10 V:<br>Max. motor capacity<br>(0 to ±10 V possible)  | 0.1 kW     | Q                   | Q        | Q           | Q           |
| U1-09 | Torque Reference                          | Monitors the internal torque reference value when vector control is used.   | 10 V: Rated torque<br>(0 to ±10 V possible)            | 0.1%       | X                   | X        | Q           | Q           |
| U1-10 | Input Term Sts<br>(Input terminal status) | Shows the ON/OFF status of inputs.<br>U1-10=00000000<br> | Can't be output.                                       | ---        | Q                   | Q        | Q           | Q           |

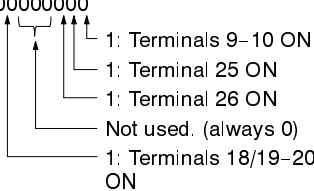
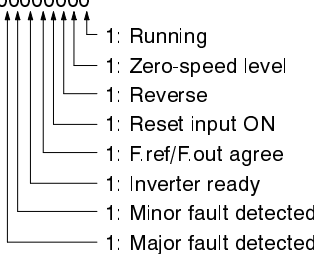

| Item  | Display  | Function  | Output signal levels for multi-function analog outputs | Min. Units | Valid access levels |          |             |             |
|-------|--|---|--|------------|---------------------|----------|-------------|-------------|
|       |  |   |  |            | V/f                 | V/f w/PG | Open Vector | Flux Vector |
| U1-11 | Output Term Sts<br>(Output terminal status)        | Shows the ON/OFF status of outputs.<br>U1-11=00000000<br>                      | Can't be output.                                       | ---        | Q                   | Q        | Q           | Q           |
| U1-12 | Int Ctl Sts 1<br>(Internal control status)         | Shows the Inverter's operating status.<br>U1-12=00000000<br>                   | Can't be output.                                       | ---        | Q                   | Q        | Q           | Q           |
| U1-13 | Elapsed Time                                       | Monitors the Inverter's elapsed operating time.<br>The initial value and running/power-on time selection can be set with parameters o2-07 and o2-08.            | Can't be output.                                       | 1 hr       | Q                   | Q        | Q           | Q           |
| U1-14 | FLASH ID   | Manufacturer's ID number  | Can't be output.                                       | ---        | Q                   | Q        | Q           | Q           |
| U1-15 | Term 13 Level<br>(Terminal 13 input voltage level) | Monitors the input voltage of the frequency reference (voltage).<br>An input of 10 V corresponds to 100%.   | 10 V: 100% (10 V)<br>(0 to ±10 V possible)             | 0.1%       | B                   | B        | B           | B           |
| U1-16 | Term 14 Level<br>(Terminal 14 input current level) | Monitors the input current of the frequency reference (current).<br>An input of 20 mA corresponds to 100%.  | 10 V: 100% (20 mA)<br>(0 to +10 V output)              | 0.1%       | B                   | B        | B           | B           |
| U1-17 | Term 16 Level<br>(Terminal 16 input voltage level) | Monitors the input voltage of the multi-function analog input.<br>An input of 10 V corresponds to 100%.   | 10 V: 100% (10 V)<br>(0 to ±10 V possible)             | 0.1%       | B                   | B        | B           | B           |
| U1-18 | Mot SEC Current                                    | Monitors the calculated value of the motor's secondary current (I <sub>q</sub> ). The motor's rated current corresponds to 100%.                                | 10 V: Rated current<br>(0 to +10 V output)             | 0.1%       | B                   | B        | B           | B           |
| U1-19 | Mot EXC Current                                    | Monitors the calculated value of the motor's excitation current (I <sub>d</sub> ). The motor's rated current corresponds to 100%.                               | 10 V: Rated current<br>(0 to +10 V output)             | 0.1%       | X                   | X        | B           | B           |
| U1-20 | SFS Output   | Monitors the output frequency after a soft start. The display shows the frequency without the correction from compensation functions such as slip compensation. | 10 V: Max. frequency<br>(0 to ±10 V possible)          | 0.01 Hz    | A                   | A        | A           | A           |
| U1-21 | ASR Input  | Monitors the input to the speed control loop. The max. frequency corresponds to 100%.   | 10 V: Max. frequency<br>(0 to ±10 V possible)          | 0.01 %     | X                   | A        | X           | A           |
| U1-22 | ASR Output   | Monitors the output from the speed control loop. The motor's rated current corresponds to 100%.   | 10 V: Rated current<br>(0 to ±10 V possible)           | 0.01 %     | X                   | A        | X           | A           |
| U1-23 | Speed Deviation                                    | Monitors the speed deviation within the speed control loop. The max. frequency corresponds to 100%.   | 10 V: Max. frequency<br>(0 to ±10 V possible)          | 0.01 %     | X                   | A        | X           | A           |
| U1-24 | PID Feedback                                       | Monitors the feedback value when PID control is used. The input for the max. frequency corresponds to 100%.   | 10 V: Max. frequency<br>(0 to ±10 V possible)          | 0.01 %     | A                   | A        | A           | A           |

| Item  | Display          | Function   | Output signal levels for multi-function analog outputs | Min. Units | Valid access levels |          |             |             |
|-------|------------------|--|--|------------|---------------------|----------|-------------|-------------|
|       |                  |  |  |            | V/f                 | V/f w/PG | Open Vector | Flux Vector |
| U1-25 | DI-16 Reference  | Monitors the command value from a 3G3FV-PDI16H2 Digital Command Card. The value will be displayed in binary or BCD depending on parameter F3-01. | Can't be output.                                       | ---        | A                   | A        | A           | A           |
| U1-26 | Voltage Ref (Vq) | Monitors the Inverter's internal voltage reference value for the motor's secondary current control.  | 10 V: 200 (400) VAC (0 to ±10 V possible)              | 0.1 V      | X                   | X        | A           | A           |
| U1-27 | Voltage Ref (Vd) | Monitors the Inverter's internal voltage reference value for the motor's excitation current control.   | 10 V: 200 (400) VAC (0 to ±10 V possible)              | 0.1 V      | X                   | X        | A           | A           |
| U1-28 | CPU ID           | Manufacturer's CPU software ID number  | Can't be output.                                       | 0.1 V      | A                   | A        | A           | A           |

**Fault Trace**

| Item  | Display          | Function  | Output signal levels for multi-function analog outputs | Min. Units | Valid access levels |          |             |             |
|-------|------------------|---|--|------------|---------------------|----------|-------------|-------------|
|       |                  |   |  |            | V/f                 | V/f w/PG | Open Vector | Flux Vector |
| U2-01 | Current Fault    | Information on the current fault  | Can't be output.                                       | ---        | Q                   | Q        | Q           | Q           |
| U2-02 | Last Fault       | Information on the last fault   |  | ---        | Q                   | Q        | Q           | Q           |
| U2-03 | Frequency Ref    | Frequency reference value when the "last fault" occurred.                         |  | 0.01 Hz    | Q                   | Q        | Q           | Q           |
| U2-04 | Output Freq      | Output frequency when the "last fault" occurred.                                  |  | 0.01 Hz    | Q                   | Q        | Q           | Q           |
| U2-05 | Output Current   | Output current when the "last fault" occurred.                                    |  | 0.1 A      | Q                   | Q        | Q           | Q           |
| U2-06 | Motor Speed      | Motor speed when the "last fault" occurred.                                       |  | 0.01 Hz    | X                   | Q        | Q           | Q           |
| U2-07 | Output Voltage   | Output voltage when the "last fault" occurred.                                    |  | 0.1 V      | Q                   | Q        | Q           | Q           |
| U2-08 | DC Bus Voltage   | The main circuit DC voltage when the "last fault" occurred.                       |  | 1 V        | Q                   | Q        | Q           | Q           |
| U2-09 | Output kWatts    | Output power when the "last fault" occurred.                                      |  | 0.1 kW     | Q                   | Q        | Q           | Q           |
| U2-10 | Torque Reference | Torque reference when the "last fault" occurred. (The rated torque = 100%.)       |  | 0.1%       | X                   | X        | Q           | Q           |
| U2-11 | Input Term Sts   | Input terminal status when the "last fault" occurred. (Same format as U1-10.)     |  | ---        | Q                   | Q        | Q           | Q           |
| U2-12 | Output Term Sts  | Output terminal status when the "last fault" occurred. (Same format as U1-11.)    |  | ---        | Q                   | Q        | Q           | Q           |
| U2-13 | Inverter status  | Inverter operating status when the "last fault" occurred. (Same format as U1-12.) |  | ---        | Q                   | Q        | Q           | Q           |
| U2-14 | Elapsed time     | Elapsed operating or power-on time when the "last fault" occurred.                |  | 1 hr       | Q                   | Q        | Q           | Q           |

**Fault History**

| Item  | Display         | Function  | Output signal levels for multi-function analog outputs | Min. Units | Valid access levels |          |             |             |
|-------|-----------------|---|--|------------|---------------------|----------|-------------|-------------|
|       |                 |   |  |            | V/f                 | V/f w/PG | Open Vector | Flux Vector |
| U3-01 | Last Fault      | Information on the last fault.  | Can't be output.                                       | ---        | Q                   | Q        | Q           | Q           |
| U3-02 | Fault Message 2 | Information on the 2 <sup>nd</sup> to last fault.                                 |  | ---        | Q                   | Q        | Q           | Q           |
| U3-03 | Fault Message 3 | Information on the 3 <sup>rd</sup> to last fault.                                 |  | ---        | Q                   | Q        | Q           | Q           |
| U3-04 | Fault Message 4 | Information on the 4 <sup>th</sup> to last fault.                                 |  | ---        | Q                   | Q        | Q           | Q           |
| U3-05 | Elapsed Time 1  | Elapsed running or power-on time when the last fault occurred.                    |  | 1 hr       | Q                   | Q        | Q           | Q           |
| U3-06 | Elapsed Time 2  | Elapsed running or power-on time when the 2 <sup>nd</sup> to last fault occurred. |  | 1 hr       | Q                   | Q        | Q           | Q           |
| U3-07 | Elapsed Time 3  | Elapsed running or power-on time when the 3 <sup>rd</sup> to last fault occurred. |  | 1 hr       | Q                   | Q        | Q           | Q           |
| U3-08 | Elapsed Time 4  | Elapsed running or power-on time when the 4 <sup>th</sup> to last fault occurred. |  | 1 hr       | Q                   | Q        | Q           | Q           |

**■ Monitoring at Startup**









- In operation mode, the frequency reference, output frequency, output current, and output voltage can be monitored immediately if the default settings are being used. One of these four values, the output voltage, can be changed to a different value. When a value other than the output voltage is to be monitored, set that value's number in parameter o1-01 (user monitor selection).
- When the power is turned on, the frequency reference will appear in the Unit's data display if the default settings are being used. Any one of the four values monitored at startup (frequency reference, output frequency, output current, or the value set in parameter o1-01) can be selected to appear when the power is turned on. The value that appears at startup is determined by parameter o1-02 (Power-On Monitor).
- Parameters o1-01 and o1-02 can be changed in the Basic or Advanced access levels. These parameters can be changed during operation.

**User Monitor Selection (Parameter o1-01)**

Use parameter o1-01 to select the values that will be monitored at startup. Use the last two digits from the "U1 Monitor" list (U1-□□) to select a value. For example, the torque reference is U1-09, so input 9 to select the torque reference.

| Parameter number | Display name     | Setting range | Units | Default setting | Valid access levels |             |                  |             |
|------------------|------------------|---------------|-------|-----------------|---------------------|-------------|------------------|-------------|
|                  |                  |               |       |                 | V/f Control         | V/f with PG | Open Loop Vector | Flux Vector |
| o1-01            | User Monitor Sel | 4 to 28       | ---   | 6               | Basic or Advanced   |             |                  |             |

The following example shows how to change parameter o1-01 so that the output power is monitored at startup instead of the output voltage.

| Key sequence  | Display                            | Explanation  |
|---|------------------------------------|--|
|          | ** Main Menu **<br>Operation       | Displays operation mode.                                 |
|          | ** Main Menu **<br>Programming     | Displays program mode.                                   |
|          | Function b1<br>Sequence            | Puts the Unit in program mode.                           |
|  2 times | Function o1<br>Monitor Select      | Displays function selection o1.                          |
|          | User Monitor Sel<br>Output Voltage | Puts the Unit in function selection o1. (Monitor Select) |
|          | o1-01= 6 ***<br>Output Voltage     | Displays the parameter setting for o1-01.                |
|  2 times | o1-01= 8 ***<br>Output kWatts      | Sets the parameter to output power.                      |
|          | Entry Accepted                     | Writes the new setting.                                  |
|   | User Monitor Sel<br>Output kWatts  | Returns to the Monitor Select display.                   |







**Note** In this example, the setting is changed in the Basic access level.

**Power-On Monitor (Parameter o1-02)**

Use parameter o1-02 to indicate which value will be displayed when the Unit is started. A setting of 1 indicates the frequency reference, 2 indicates the output frequency, 3 indicates the output current, and 4 indicates the value set in parameter o1-01.

| Parameter number | Display name     | Setting range | Units | Default setting | Valid access levels |             |                  |             |
|------------------|------------------|---------------|-------|-----------------|---------------------|-------------|------------------|-------------|
|                  |                  |               |       |                 | V/f Control         | V/f with PG | Open Loop Vector | Flux Vector |
| o1-02            | Power-On Monitor | 1 to 4        | ---   | 1               | Basic or Advanced   |             |                  |             |

The following example shows how to change parameter o1-02 so that the output current is displayed at startup. (The procedure continues from the end of the previous example.)

| Key sequence  | Display                            | Explanation  |
|---|------------------------------------|--|
|   | User Monitor Sel<br>Output kWatts  | Monitor Select display (See the previous example.) |
|          | Power-On Monitor<br>Frequency Ref  | Displays the Power-On Monitor display.             |
|          | o1-02= 1 ***<br>Frequency Ref      | Displays the parameter setting for o1-02.          |
|  2 times | O1-02= 3<br>Output Current         | Sets the parameter to output current.              |
|          | Entry Accepted                     | Writes the new setting.                            |
|   | Power-On Monitor<br>Output Current | Returns to the Power-On Monitor display.           |
|          | Function o1<br>Monitor Select      | Returns to the function selection o1 display.      |
|          | ** Main Menu **<br>Programming     | Returns to the program mode display.               |

**Note** In this example, the setting is changed in the Basic access level.

### 3-4 Initialize Mode

The initialize mode is used to select the language displayed by the Unit, the access level, and the control mode; it is also used to initialize the Unit's parameters.







#### ■ Selecting the Display Language

Use parameter A1-00 to select the language displayed by the Unit. A value of 0 indicates English and a value of 1 indicates Japanese. This parameter is not initialized by the initialize operation and it can be changed during operation.

| Parameter number | Display name    | Setting range | Units | Default setting | Valid access levels             |             |                  |             |
|------------------|-----------------|---------------|-------|-----------------|---------------------------------|-------------|------------------|-------------|
|                  |                 |               |       |                 | V/f Control                     | V/f with PG | Open Loop Vector | Flux Vector |
| A1-00            | Select Language | 0 or 1        | ---   | 0               | Quick-start, Basic, or Advanced |             |                  |             |

#### Example

The following example shows how to change parameter A1-00 so that Japanese is displayed instead of English.

| Key sequence  | Display                       | Explanation  |
|---|-------------------------------|--|
|  | ** Main Menu **<br>Operation  | Displays operation mode.                                       |
|  | ** Main Menu **<br>Initialize | Displays initialize mode.                                      |
|  | Select Language<br>English    | Puts the Unit in initialize mode.<br>(Select Language display) |
|  | A1-00= 0<br>English           | Displays the parameter setting for A1-00.                      |
|  | A1-00= 1 ***<br>FN]:^         | Sets the display language to English.                          |
|  | <^.3=3 67:P6]                 | Writes the new setting.  |
|   | 9^]:^ >]@8<br>FN]:^           | Returns to the Select Language display.                        |

#### ■ Setting the Access Level

Use parameter A1-01 to select the parameter access level. This level determines which parameters can be displayed and changed. (The parameters which can be displayed and changed also depend upon the control mode being used.) This parameter can be changed during operation.

| Parameter number | Display name | Setting range | Units | Default setting | Valid access levels             |             |                  |             |
|------------------|--------------|---------------|-------|-----------------|---------------------------------|-------------|------------------|-------------|
|                  |              |               |       |                 | V/f Control                     | V/f with PG | Open Loop Vector | Flux Vector |
| A1-01            | Access Level | 0 to 4        | ---   | 2               | Quick-start, Basic, or Advanced |             |                  |             |

**Access Level Settings**

| Setting | Name           | Function  |
|---------|----------------|---|
| 0       | Operation Only | This setting allows operation mode and initialize mode to be displayed or changed. Use this setting to prevent parameter settings from being changed.                             |
| 1       | User Program   | This setting allows only the user-selected parameters (up to 32) to be displayed or changed. Select the desired parameters as “User Constants” in parameters A2-01 through A2-32. |
| 2       | Quick-start    | This setting allows the parameters required to start the Inverter (about 25) to be displayed or changed.  |
| 3       | Basic          | This setting allows the commonly used parameters to be displayed or changed.  |
| 4       | Advanced       | This setting allows all parameters to be displayed or changed.  |

**■ Setting the Control Mode**

Use parameter A1-02 to select one of the four control modes. This parameter is not initialized by the initialize operation and it cannot be changed during operation.

| Parameter number | Display name   | Setting range | Units | Default setting | Valid access levels             |             |                  |             |
|------------------|----------------|---------------|-------|-----------------|---------------------------------|-------------|------------------|-------------|
|                  |                |               |       |                 | V/f Control                     | V/f with PG | Open Loop Vector | Flux Vector |
| A1-02            | Control Method | 0 to 3        | ---   | 2               | Quick-start, Basic, or Advanced |             |                  |             |

**Control Mode Settings**







| Setting | Name             | Function   |
|---------|------------------|--|
| 0       | V/f Control      | V/f control without pulse generator (normal V/f control)   |
| 1       | V/f w/PG Fdbk    | V/f control with pulse generator (V/f control using a PG Speed Control Card)                               |
| 2       | Open Loop Vector | Vector control without pulse generator<br>(Vector control using the Inverter’s internal speed information) |
| 3       | Flux Vector      | Vector control with pulse generator<br>(Vector control using a PG Speed Control Card)                      |

**Control Mode Characteristics**

| Characteristic           | V/f Control   | V/f w/PG Fdbk   | Open Loop Vector  | Flux Vector  |
|--------------------------|---|---|---|--|
| Basic control method     | Voltage/frequency control (open loop)                             | Voltage/frequency control with speed compensation                               | Current vector control without PG   | Current vector control with PG   |
| Speed detector           | Not required  | Required (pulse generator)  | Not required  | Required (pulse generator)   |
| Optional Speed Detectors | Not required  | 3G3FV-PPGA2 or 3G3FV-PPGD2  | Not required  | 3G3FV-PPGB2 or 3G3FV-PPGX2   |
| Speed control range      | 1:40  | 1:40  | 1:100   | 1:1,000  |
| Starting torque          | 150%/3 Hz   | 150%/3 Hz   | 150%/1 Hz   | 150%/0 Hz  |
| Speed control precision  | ±2 to 3%  | ±0.03%  | ±0.2%   | ±0.02%   |
| Torque limit             | Not possible  | Not possible  | Possible  | Possible   |
| Torque control           | Not possible  | Not possible  | Not possible  | Possible   |
| Example applications     | <ul style="list-style-type: none"> <li>Multiple motors</li> </ul> | <ul style="list-style-type: none"> <li>Simple speed feedback control</li> </ul> | <ul style="list-style-type: none"> <li>Variable speed drive applications</li> </ul> | <ul style="list-style-type: none"> <li>Simple servo drives</li> <li>Precision speed control</li> <li>Torque control</li> </ul> |

**Example**

The following example shows how to change parameter A1-02 to select Flux Vector control (vector control with pulse generator).

| Key sequence  | Display                            | Explanation  |
|---|------------------------------------|--|
|          | ** Main Menu **<br>Operation       | Displays operation mode.                                       |
|          | ** Main Menu **<br>Initialize      | Displays initialize mode.                                      |
|          | Select Language<br>English         | Puts the Unit in initialize mode.<br>(Select Language display) |
|  2 times | Control Method<br>Open Loop Vector | Displays the Control Method display.                           |
|          | A1-02= 2<br>Open Loop Vector       | Displays the parameter setting for A1-02.                      |
|          | A1=02 3<br>Flux Vector             | Changes the setting to Flux Vector.                            |
|          | Entry Accepted                     | Writes the new setting.  |
|   | Control Method<br>Flux Vector      | Returns to the Control Method display.                         |

■ **Initializing the Parameters**

Use parameter A1-03 to initialize the parameters. This parameter cannot be changed during operation.

| Parameter number | Display name    | Setting range          | Units | Default setting | Valid access levels             |             |                  |             |
|------------------|-----------------|------------------------|-------|-----------------|---------------------------------|-------------|------------------|-------------|
|                  |                 |                        |       |                 | V/f Control                     | V/f with PG | Open Loop Vector | Flux Vector |
| A1-03            | Init Parameters | 0, 1110, 2220, or 3330 | ---   | 0               | Quick-start, Basic, or Advanced |             |                  |             |

**Initialize Parameters Settings**

| Setting | Function  |
|---------|---|
| 0       | Returns to the Initialize display without initializing any parameters.  |
| 1110    | Initializes the parameters to the user settings.<br>This function initializes the parameters to values that have been recorded as user settings. To record the user settings, change the parameters to the desired values and then set parameter o2-03 (User Defaults) to 1. (The 1110 function is disabled when parameter o2-03 is 0.) |
| 2220    | 2-wire sequential initialization (Initializes the parameters to the factory settings.)  |
| 3330    | 3-wire sequential initialization  |

● **Example of Wiring for 2-wire Sequential Operation**

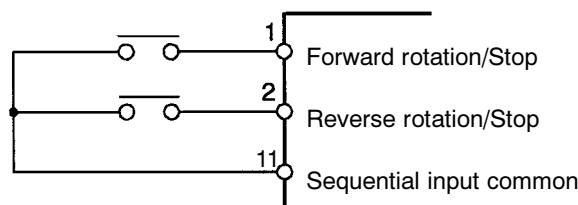



● Example of Wiring for 3-wire Sequential Operation

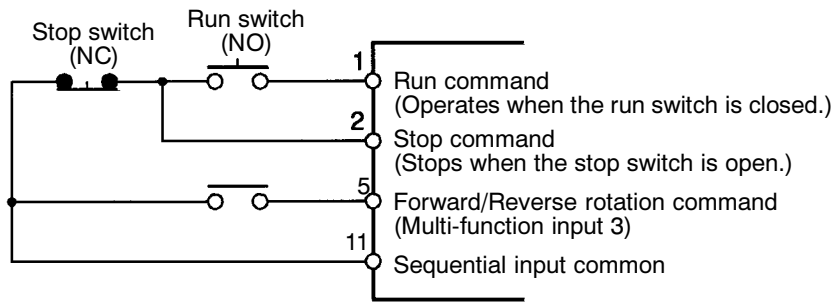

**Note 1.** The default settings of the multi-function inputs are different from the default settings of the 2-wire sequence.

**Note 2.** When setting a 3-wire sequence, the operation can be started and stopped with an automatically resetting pushbutton switch.

**Initialization Example**

The following example shows how to initialize parameters with the 2-wire sequence (factory settings).

| Key sequence | Display                          | Explanation  |
|--------------|----------------------------------|--|
| MENU         | ** Main Menu **<br>Operation     | Displays operation mode.                                       |
|              | ** Main Menu **<br>Initialize    | Displays initialize mode.                                      |
|              | Select Language<br>English       | Puts the Unit in initialize mode.<br>(Select Language display) |
| 3 times      | Init Parameters<br>No Initialize | Displays the Initialize display.                               |
|              | A1-03= 0 ***<br>No Initialize    | Displays the parameter setting for A1-03.                      |
|              | A1-03= 2220<br>2-wire Initial    | Changes the setting to 2-wire Initialization.                  |
|              | Entry Accepted                   | Writes the new setting.  |
|              | Init Parameters<br>No Initialize | Returns to the Initialize display.                             |

■ Write-protect Passwords

Use parameters A1-04 and A1-05 to write-protect the initialize-mode parameters. Parameters A1-01 through A1-03 and A2-01 through A2-32 can be displayed but not changed if the contents of A1-04 and A1-05 don't match. These parameters cannot be changed during operation.

To write-protect the initialize-mode parameters, set the password in A1-05 after inputting the desired values in A1-01 through A1-03 and A2-01 through A2-32. Parameter A1-05 can be displayed by displaying A1-04 and pressing the Menu Key while pressing the Reset Key. (A1-05 can't be displayed with the usual key sequences.)











It will be possible to change the initialize-mode parameters again when the password is written to A1-04.

| Parameter number | Display name   | Setting range | Units | Default setting | Valid access levels             |             |                  |             |
|------------------|----------------|---------------|-------|-----------------|---------------------------------|-------------|------------------|-------------|
|                  |                |               |       |                 | V/f Control                     | V/f with PG | Open Loop Vector | Flux Vector |
| A1-04            | Enter Password | 0000 to 9999  | ---   | 0               | Quick-start, Basic, or Advanced |             |                  |             |

| Parameter number | Display name    | Setting range | Units | Default setting | Valid access levels             |             |                  |             |
|------------------|-----------------|---------------|-------|-----------------|---------------------------------|-------------|------------------|-------------|
|                  |                 |               |       |                 | V/f Control                     | V/f with PG | Open Loop Vector | Flux Vector |
| A1-05            | Select Password | 0000 to 9999  | ---   | 0               | Quick-start, Basic, or Advanced |             |                  |             |

**Password Setting Example**

The following example shows how to set the password to “1000.”

| Key sequence  | Display                        | Explanation  |
|---|--------------------------------|--|
|    | ** Main Menu **<br>Operation   | Displays operation mode.   |
|    | ** Main Menu **<br>Initialize  | Displays initialize mode.  |
|    | Select Language<br>English     | Puts the Unit in initialize mode.<br>(Select Language display)                                   |
|  4 times  | Enter Password<br>A1-04= 0     | Displays the Enter Password display.   |
|  +  | Select Password<br>A1-05= 0    | Press and hold the Reset Key and then press the Menu Key to display A1-05.                       |
|    | Select Password<br>0000        | Selects the parameter so that the leading 0 flashes.<br>(The digit that can be changed flashes.) |
|    | Select Password<br>1000        | Changes the password to 1000.  |
|    | Entry Accepted                 | Writes the new setting.  |
|   | Select Password<br>A1-05= 1000 | Returns to the Select Password display (A1-05).  |
|    | Enter Password<br>A1-04= 0     | Returns to the Enter Password display (A1-04).   |

**■ User Constants**

Parameters A2-01 through A2-32 specify the parameters that can be displayed and changed when the access level parameter (A1-01) is set to 1. Parameters A2-01 through A2-32 can be changed only in the Advanced access level and cannot be changed during operation.

















| Parameter numbers | Display name                          | Setting range  | Units | Default setting | Valid access levels |             |                  |             |
|-------------------|---------------------------------------|----------------|-------|-----------------|---------------------|-------------|------------------|-------------|
|                   |                                       |                |       |                 | V/f Control         | V/f with PG | Open Loop Vector | Flux Vector |
| A2-01 to A2-32    | User parameter 1 to User parameter 32 | b1-01 to o2-08 | ---   | ---             | Advanced            |             |                  |             |

The following restrictions apply to setting/displaying parameters when the access level is set to the user program.

| Mode               | Accessible parameters   |
|--------------------|---|
| Operation          | The Quick-start level parameters can be displayed.                            |
| Initialize         | The Quick-start level parameters can be set or displayed.                     |
| Program            | Only the parameters specified in A2-01 through A2-32 can be set or displayed. |
| Auto-tuning        | The parameters cannot be displayed.   |
| Modified constants | The parameters cannot be displayed.   |

### Setting Example

The following example shows how to specify parameter C1-01 (Acceleration time 1) in user constant A2-01 and set the access level to the user program.

| Key sequence  | Display                        | Explanation  |
|---|--------------------------------|--|
|            | ** Main Menu **<br>Operation   | Displays operation mode.   |
|            | ** Main Menu **<br>Initialize  | Displays initialize mode.  |
|            | Select Language<br>English     | Puts the Unit in initialize mode.<br>(Select Language display)                                       |
|            | Function A2<br>User Constants  | Displays the User Constants display.   |
|           | User Param 1<br>A2-01= -----   | Displays the parameter setting for A2-01.  |
|          | User Param 1<br>-----          | Selects the parameter so that the leading digit flashes.<br>(The digit that can be changed flashes.) |
|  2 times | User Param 1<br>C1-01          | Sets the first digit to "C."<br>(At this point the other digits will be displayed.)                  |
|  2 times | User Param 1<br>C1-01          | Moves the cursor to the third digit.   |
|  7 times | User Param 1<br>C1-08          | Sets the last digits to "08."  |
|          | Entry Accepted                 | Writes the new setting.  |
|   | User Param 1<br>A2-01= C1-08   | Returns to the parameter setting for A2-01.  |
|          | Function A2<br>User Constants  | Returns to the User Constants display.   |
|  2 times | Access Level<br>Advanced Level | Displays the Access Level display.   |
|          | A1-01= 4<br>ADVANCED           | Displays the parameter setting for A1-01.  |
|  2 times | A1-01= 1<br>User Program       | Changes the setting to "User Program."   |
|          | Entry Accepted                 | Writes the new setting.  |
|   | Access Level<br>User Program   | Returns to the Access Level display.   |
|          | ** Main Menu **<br>Initialize  | Returns to the initialize mode display.  |

**Note** The access level can be set to “User Program” after at least one parameter has been specified in A2-01 through A2-32. The “User Program” selection won’t appear as an option for parameter A1-01 unless a parameter has been specified in A2-01 through A2-32.

■ Initialize Mode Parameter Levels (Reference)

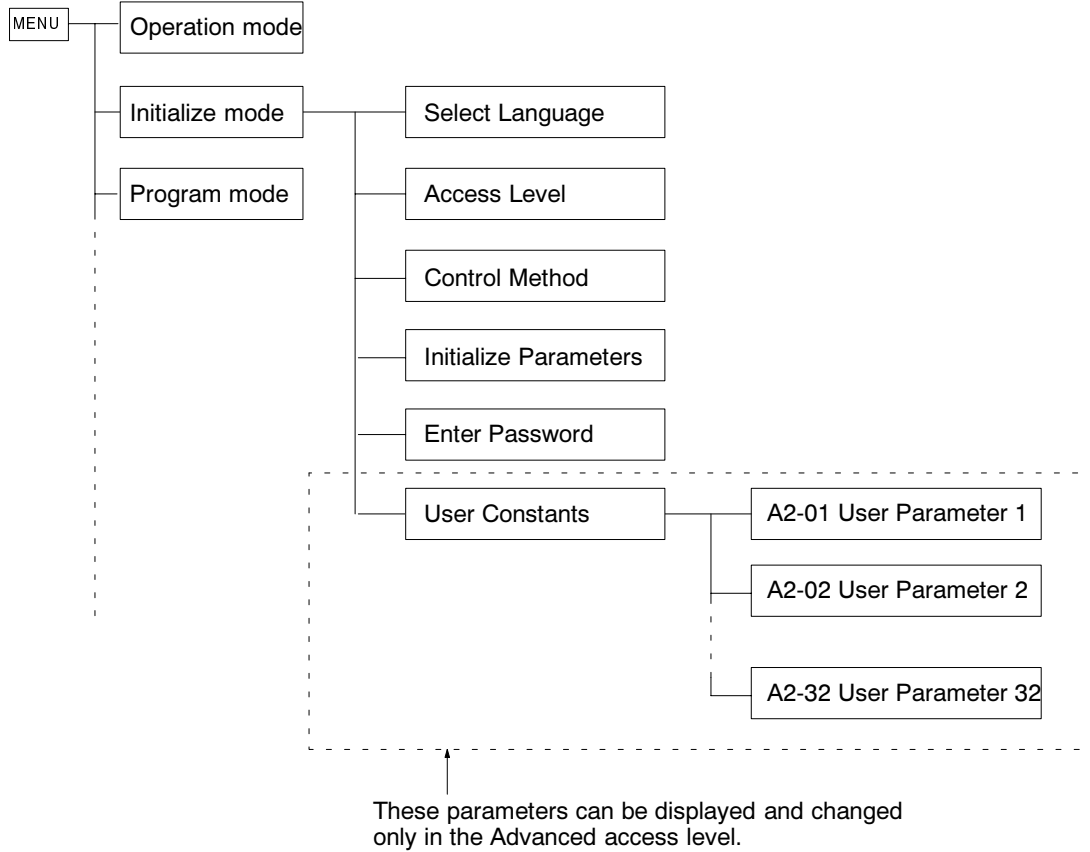

### 3-5 Program Mode

The Inverter parameters can be set in program mode. The parameters which can be displayed and changed depend on the access level and control mode that are being used. Refer to the following table to determine if a parameter can be changed.

#### ■ Parameter Groups

An “OK” in the control mode column indicates that the parameter can be changed in that control mode.

| Group       | Function |                  | Comments  | Control mode |          |                  |             |
|-------------|----------|------------------|---|--------------|----------|------------------|-------------|
|             |          |                  |   | V/f          | V/f w/PG | Open-loop Vector | Flux Vector |
| Application | b1       | Sequence         | Settings such as the reference input method     | OK           | OK       | OK               | OK          |
|             | b2       | DC Braking       | DC braking function settings                    | OK           | OK       | OK               | OK          |
|             | b3       | Speed Search     | Speed search function settings                  | OK           | OK       | OK               | OK          |
|             | b4       | Delay Timers     | Timer function settings                         | OK           | OK       | OK               | OK          |
|             | b5       | PID Control      | PID control settings                            | OK           | OK       | OK               | OK          |
|             | b6       | Reference Hold   | Accel/deceleration time dwell function settings | OK           | OK       | OK               | OK          |
|             | b7       | Droop Control    | Droop control (speed drop) settings             | ---          | ---      | ---              | OK          |
|             | b8       | Energy Saving    | Terminal input energy-saving control settings   | OK           | OK       | ---              | ---         |
|             | b9       | Zero Servo       | Stop in the position loop                       | ---          | ---      | ---              | OK          |
| Tuning      | C1       | Accel/Decel      | Acceleration/deceleration time settings         | OK           | OK       | OK               | OK          |
|             | C2       | S-Curve Acc/Dec  | S-curve characteristics for accel/decel times   | OK           | OK       | OK               | OK          |
|             | C3       | Motor-Slip Comp  | Slip compensation function settings             | OK           | OK       | OK               | OK          |
|             | C4       | Torque Comp      | Torque compensation function settings           | OK           | OK       | OK               | ---         |
|             | C5       | ASR Tuning       | Speed control loop parameter settings           | ---          | OK       | ---              | OK          |
|             | C6       | Carrier Freq     | Carrier frequency settings                      | OK           | OK       | OK               | OK          |
|             | C7       | Hunting Prev     | Hunting prevention function for V/f control     | OK           | OK       | ---              | ---         |
|             | C8       | Factory Tuning   | Adjustment for open-loop vector control         | ---          | ---      | OK               | ---         |
| Reference   | d1       | Preset Reference | Operator frequency reference settings           | OK           | OK       | OK               | OK          |
|             | d2       | Reference Limits | Frequency upper and lower limit settings        | OK           | OK       | OK               | OK          |
|             | d3       | Jump Frequencies | Prohibited frequency settings                   | OK           | OK       | OK               | OK          |
|             | d4       | Sequence         | Hold for analog frequency reference             | OK           | OK       | OK               | OK          |
|             | d5       | Torque Control   | Parameter settings for torque control           | ---          | ---      | ---              | OK          |
| Motor       | E1       | V/f Pattern      | Sets the motor's V/f characteristics.           | OK           | OK       | OK               | OK          |
|             | E2       | Motor Setup      | Sets the motor constants.                       | OK           | OK       | OK               | OK          |
| Options     | F1       | PG Option Setup  | Parameter settings for a PG Card                | ---          | OK       | ---              | OK          |
|             | F2       | AI-14 Setup      | Parameter settings for an Analog Reference Card | OK           | OK       | OK               | OK          |
|             | F3       | DI-08, 16 Setup  | Parameter settings for a Digital Reference Card | OK           | OK       | OK               | OK          |
|             | F4       | AO-08, 12 Setup  | Parameter settings for an Analog Monitor Card   | OK           | OK       | OK               | OK          |
|             | F5       | Not used (DO-02) | Not Used. (Do not change these settings.)       | ---          | ---      | ---              | ---         |
|             | F6       | Not used (DO-08) |   |              |          |                  |             |
|             | F7       | PO-36F Setup     | Parameter settings for a Pulse Monitor Card     | OK           | OK       | OK               | OK          |
| Terminal    | H1       | Digital Inputs   | Function selection for multi-function inputs    | OK           | OK       | OK               | OK          |
|             | H2       | Digital Outputs  | Function selection for multi-function outputs   | OK           | OK       | OK               | OK          |
|             | H3       | Analog Inputs    | Function selection for analog inputs            | OK           | OK       | OK               | OK          |
|             | H4       | Analog Outputs   | Function selection for analog outputs           | OK           | OK       | OK               | OK          |
|             | H5       | Serial Com Setup | Not Used. (Do not change these settings.)       | ---          | ---      | ---              | ---         |

| Group      | Function |                  | Comments                                       | Control mode |          |                  |             |
|------------|----------|------------------|--|--------------|----------|------------------|-------------|
|            |          |                  |  | V/f          | V/f w/PG | Open-loop Vector | Flux Vector |
| Protection | L1       | Motor Overload   | Overload protection settings and selection     | OK           | OK       | OK               | OK          |
|            | L2       | PwrLoss Ridethru | Selects the power-loss processing method.      | OK           | OK       | OK               | OK          |
|            | L3       | Stall Prevention | Stall prevention settings and selection        | OK           | OK       | OK               | OK          |
|            | L4       | Ref Detection    | Frequency detection settings and selection     | OK           | OK       | OK               | OK          |
|            | L5       | Fault Restart    | Fault restart function settings                | OK           | OK       | OK               | OK          |
|            | L6       | Torque Detection | Overtorque detection settings and selection    | OK           | OK       | OK               | OK          |
|            | L7       | Torque Limit     | Torque limit settings (vector control only)    | ---          | ---      | OK               | OK          |
|            | L8       | Hdwe Protection  | Overheating and phase loss protection settings | OK           | OK       | OK               | OK          |
| Operator   | o1       | Monitor Select   | Selects the display and setting methods.       | OK           | OK       | OK               | OK          |
|            | o2       | Key Selections   | Key function selection and other parameters    | OK           | OK       | OK               | OK          |

### ■ Setting Parameters in Program Mode

The parameters that can be displayed and changed will vary depending on the access level that has been set.

In the Quick-start level, the first parameter (b1-01) will be displayed when the Enter Key is pressed at the program mode display. In the Basic level, the first function (b1) will be displayed when the Enter Key is pressed at the program mode display. In the Advanced level, the first group (b) will be displayed when the Enter Key is pressed at the program mode display.

For setting examples, refer to *Setting Parameters in Each Access Level* on page 3-6.

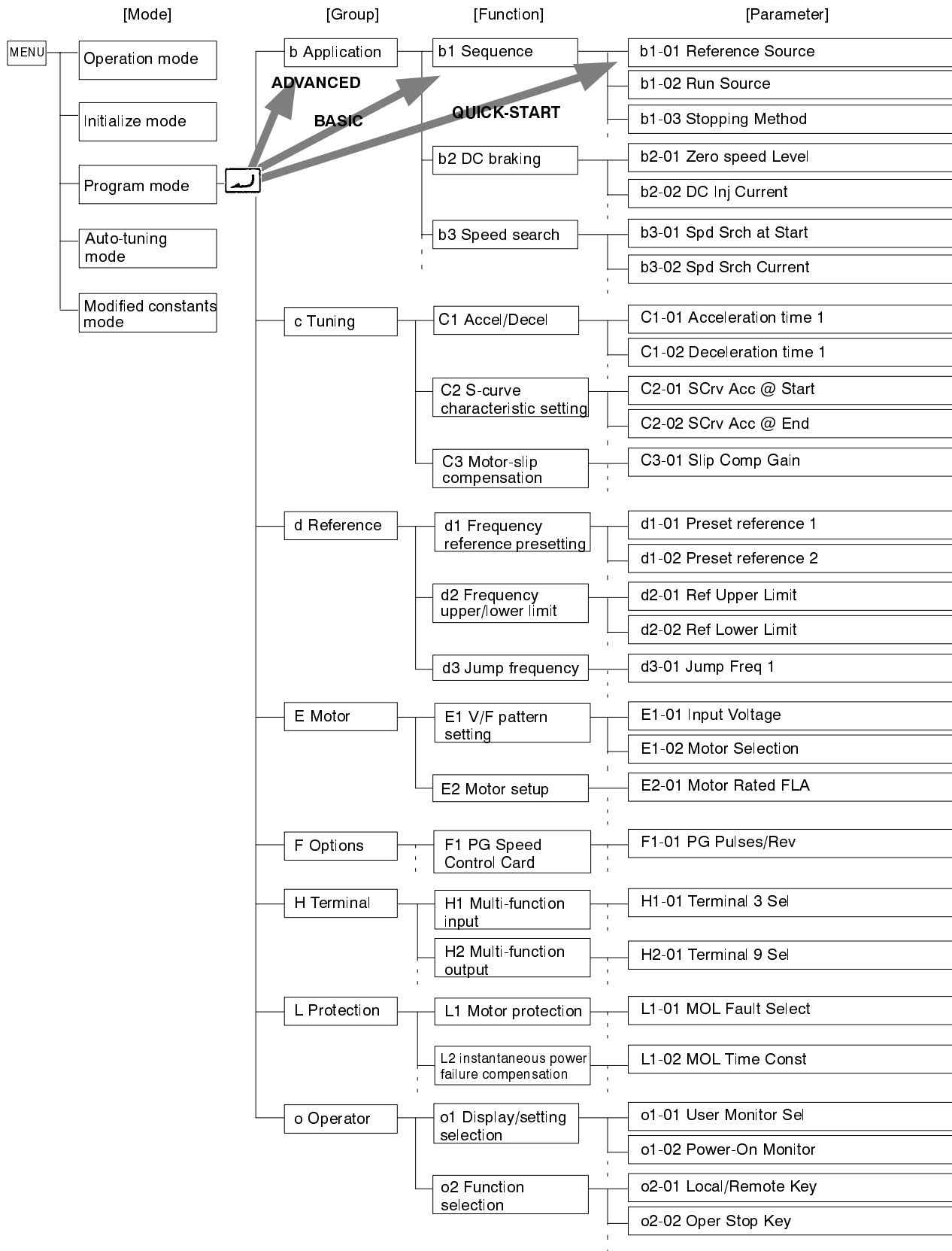

**Note** The above parameter levels are simplified levels used mainly in programming operation.

---

## 3-6 Auto-tuning Mode

---

---

---

The auto-tuning function automatically tunes and sets the required motor constants when operating in the open-loop or flux vector control modes.

When the rated voltage, rated current, rated frequency, rated rotational frequency, and number of poles listed on the motor's nameplate have been input and the Run Key is pressed, the motor constants calculated from these values are written to E1-01 through E2-08 automatically.

The auto-tuning mode won't be displayed if V/f control has been selected.

---

---

### ■ Precautions for Auto-tuning Operation

















**Caution**

Do not connect a load to the motor when performing auto-tuning. Doing so may result in personal injury or equipment damage.

- The Inverter's auto-tuning function automatically determines the motor constants while a servo system's auto-tuning function determines the size of a load, so these auto-tuning functions are fundamentally different.
- If a load is connected when auto-tuning is performed, not only will incorrect motor constants be recorded, but the motor may operate erratically resulting in dangerous conditions such as loads falling from vertical axis motors. Never perform auto-tuning with a load connected to the motor.



■ Auto-tuning Operation Example

| Key sequence  | Display   | Explanation  |
|---|---|--|
|    | ** Main Menu **<br>Operation  | Displays operation mode.   |
|  3 times   | ** Main Menu **<br>Auto-Tuning  | Displays auto-tuning mode.   |
|    | Rated Voltage<br>200.0 VAC  | Displays the rated voltage.  |
|    | Rated Voltage<br>200.0 VAC  | When changing the rated voltage, press the Enter Key again to enter input mode. (The digits will flash.)               |
|    | Rated Voltage<br>200.0 VAC  | Use the Reset, Up Arrow and Down Arrow Keys to change the rated voltage setting.                                       |
|    | Entry Accepted  | Writes the new setting.  |
|   | Rated Voltage<br>200.0 VAC  | Returns to the rated voltage display.  |
|    | Rated Current<br>1.90 A   | Displays the rated current.<br>Follow the procedure used to change for the rated voltage when changing this setting.   |
|    | Rated Frequency<br>60.0 Hz  | Displays the rated frequency.<br>Follow the procedure used to change for the rated voltage when changing this setting. |
|    | Rated Speed<br>1750 RPM   | Displays the rated speed.<br>Follow the procedure used to change for the rated voltage when changing this setting.     |
|    | Number of Poles<br>4  | Displays the number of poles.<br>Follow the procedure used to change for the rated voltage when changing this setting. |
|    | Select Motor 1/2<br>1   | Displays the motor selection.<br>(Selection of motor 1 parameter or motor 2 parameter)                                 |
|    | Tuning Ready ?<br>Press RUN key   | Displays a confirmation prompt for the start of the auto-tuning function. (The lower line will flash.)                 |
|    | Tune Proceeding<br><input type="checkbox"/> HZ <input type="checkbox"/> A | Starts the auto-tuning function.<br>(The upper line will flash.)   |
|   | Tune Successful   | Indicates the completion of auto-tuning.   |
|    | ** Main Menu **<br>Operation  | Returns to the operation mode display.   |









### 3-7 Modified Constants Mode

The modified constants mode is used to display or change parameters that have been changed from their factory-preset values.

When any parameters have been changed in program mode (b1-01 through o2-08), pressing the Enter Key in modified constants mode will cause these parameters to be displayed. (The initialize-mode parameters won't be displayed.)

#### ■ Modified Constants Mode Operations

- In the following example, parameters C1-01 (acceleration time 1) and d1-01 (preset reference 1) have been changed from their factory settings.
- The settings for these two parameters are displayed and the setting for d1-01 is changed from "60.00 Hz" to "30.00 Hz."

| Key sequence  | Display                            | Explanation  |
|---|------------------------------------|--|
|    | ** Main Menu **<br>Operation       | Displays operation mode.   |
|    | ** Main Menu **<br>Modified Consts | Displays modified constants mode.  |
|    | Accel Time 1<br>c1-01= 20.0 Sec    | Displays acceleration time 1 (C1-01).  |
|    | Frequency Ref 1<br>d1-01= 60.00 Hz | Displays frequency reference 1 (d1-01).  |
|    | Frequency Ref 1<br>060.00 Hz       | Pressing Enter allows the setting to be changed. (The leading digit will flash.) |
|   | Frequency Ref 1<br>030.00 Hz       | Changes the setting to "30.00 Hz."   |
|    | Entry Accepted                     | Writes the new setting.  |
|   | Frequency Ref 1<br>d1-01= 30.00 Hz | Returns to the frequency reference 1 display.                                    |
|    | ** Main Menu **<br>Modified Consts | Returns to the modified constants mode display.                                  |

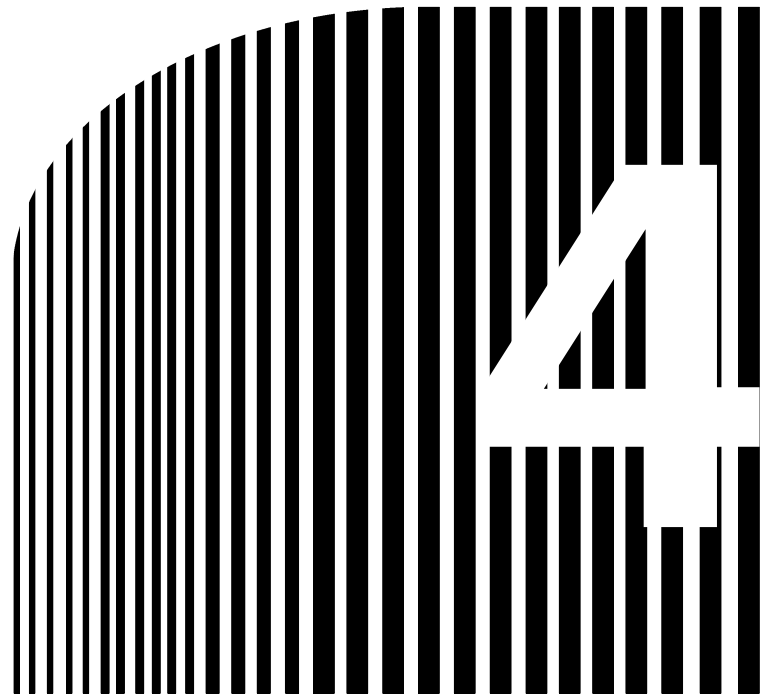











## Chapter 4

### • Trial Operation •

4-1 Procedure

4-2 Operation Example

## ■ Cautions and Warnings

-  **WARNING** Before turning ON the power supply, be sure to attach the front cover, terminal cover, Digital Operator, and optional items. Otherwise, an electric shock may occur.
-  **WARNING** Don't detach the front cover, terminal cover, Digital Operator, or optional items while power is being supplied. Otherwise, an electric shock may occur.
-  **WARNING** Don't touch the Digital Operator or switches with wet hands. Otherwise, an electric shock may occur.
-  **WARNING** Don't touch the Inverter terminal while power is being supplied. Otherwise, an electric shock may occur.
-  **WARNING** As the unit stopped by an alarm will suddenly start again when the Fault Retry is used, don't come close to the unit while the Fault Retry is used. Otherwise, an injury may occur.
-  **WARNING** As the Digital Operator's STOP Key is valid only when its function is set, provide a separate emergency stop switch. Otherwise, an injury may occur.
-  **WARNING** As the unit will suddenly start if the power is turned ON, the alarm is reset, or the Local/Remote Key is pushed while the RUN signal is ON, don't come close to the unit. Otherwise, an injury may occur.
-  **WARNING** As the radiation fin (heat sink), braking resistor, and Braking Resistor Unit become hot, don't touch them. Otherwise, a burn injury may occur.
-  **WARNING** Provide a separate holding brake if necessary. Otherwise, an injury may occur.
-  **Caution** Don't check signals while the unit is running. Otherwise, an injury or equipment damage may occur.
-  **WARNING** Be careful when changing settings. Otherwise, an injury or equipment damage may occur.

---

## 4-1 Procedure

---

### 1. Installation and Mounting

Install the Inverter according to the installation conditions. Refer to page 2-2. Ensure that the installation conditions are met.

### 2. Wiring and Connection

Connect to the power supply and peripheral devices. Refer to page 2-10. Select peripheral devices which meet the specifications and wire correctly.

### 3. Power Connection

Carrying out the following pre-connection checks before turning on the power supply:

- Always ensure that a power supply of the correct voltage is used and that the power input terminal (L1, L2, L3) is wired correctly.
  - 200-V class: 3-phase 200 to 230 VDC, 50/60 Hz
  - 400-V class: 3-phase 380 to 460 VDC, 50/60 Hz
- Make sure that the Motor output terminal (T1, T2, T3) and the Motor are connected correctly.
- Ensure that the control circuit terminals and the control device are wired correctly. Make sure that all control terminals are turned OFF.
- When using a PG Speed Control Card, ensure that it is wired correctly.
- Set the motor to no-load status, (not connected to the mechanical system).
- Having conducted the above checks, connect the power supply.

### 4. Check the Display Status

Check to be sure that there are no faults in the Inverter.

- If the display at the time the power is connected is normal, it will read as follows:
  - Data Display: Frequency Ref
- When an fault has occurred, the details of the fault will be displayed. In that case, refer to *Section 8 Maintenance Operations*.

### 5. Initializing Parameters

Initialize the parameters.

### 6. Setting the Input Voltage

Set the Inverter input voltage (E1-01) to the correct voltage. (At the same time, set the short pin for the 400-V class models of 18.5 KW or larger.)

### 7. Auto-tuning

Execute auto-tuning in the open-loop vector control mode.

- When auto-tuning is executed, motor constants are set automatically.
- When this is not possible using auto-tuning, switch to V/f control mode and set the V/f pattern.

### 8. No-load Operation

Start the no-load motor using the Digital Operator.

- Set the frequency reference using the Digital Operator and start the motor using key sequences.

### 9. Actual Load Operation

Connect the mechanical system and operate using the Digital Operator.

- When there are no difficulties using the no-load operation, connect the mechanical system to the motor and operate using the Digital Operator.

**10. Operation**

Basic Operation: Operation based on the basic settings required to start and stop the Inverter. Refer to page 5-2.

Applied Operation: Operation which uses PID control or other functions. Refer to page 6-1.

- For operation within standard parameters select “Basic Operation.”
- To use the various applied functions such as, direct current control braking, speed search, timer, S-curve acceleration/deceleration, slip correction, torque compensation, drip control, position lock, and torque control, select “Applied Operation” in combination with “Basic Operation.”

---

## 4-2 Operation Example

---

### 4-2-1 Power Connection

#### ■ Checkpoints before Connecting the Power Supply

- Check that the power supply is of the correct voltage.
  - 200-V class: 3-phase 200 to 230 VDC, 50/60 Hz
  - 400-V class: 3-phase 380 to 460 VDC, 50/60 Hz
- Make sure that the Motor output terminal (T1, T2, T3) and the Motor are connected correctly.
- Ensure that the control circuit terminal and the control device are wired correctly. Set all control circuit terminals to OFF.
- When using a PG Speed Control Card, ensure that it is wired correctly.
- Set the motor to no-load status, (not connected to the mechanical system).

#### ■ Connecting the Power Supply

- Having conducted the above checks, connect the power supply.

### 4-2-2 Checking the Display Status

- If the display at the time the power is connected is normal, it will read as follows:

**Normal**      Frequency Ref  
                  U1-01= 0.00 HZ

The frequency reference monitor is displayed in the data display section.









- When an fault has occurred, the details of the fault will be displayed. In that case, refer to *Section 8 Maintenance Operations*.

**Fault**            UV  
                  Under Voltage

The display will differ depending on the type of fault.

### 4-2-3 Initializing Parameters

- Initialize the parameters using the following procedure. (Returns to default settings).
- To initialize the parameters, set “2220” in A1-03 (Initialize).
- After initialization the access level is set to Quick-start (A1-01). The following table shows the setting method for Quick-start.

| Key sequence  | Display                         | Explanation   |
|---|---------------------------------|---|
|   | Frequency Ref<br>U1-01= 0.00 Hz | Frequency reference display.  |
|          | ** Main Menu **<br>Operation    | Displays operation mode.  |
|          | ** Main Menu **<br>Initialize   | Displays initialize mode.   |
|          | Select Language English         | Puts the Unit in initialize mode.   |
|  3 times | Initialize Select               | Displays the Initialize display.  |
|          | A1-03= 0 *** Select             | Displays the parameter setting for A1-03.   |
|          | A1-03= 2220 2-wire Initial      | Changes the setting to 2-wire Initialization.                                       |
|          | Entry Accepted                  | Writes the set values. “Entry Accepted” is displayed for approximately 0.5 seconds. |
|   | Initialize Select               | Returns to the Initialize display.  |
|         | ** Main Menu **<br>Initialize   | Returns to the initialize mode display.   |

### 4-2-4 Setting Input Voltage









- Set the input voltage of the Inverter (E1-01) according to the current voltage. This parameter cannot be changed during operation.

| Parameter number | Display name  | Setting range           | Units | Default setting | Valid access levels             |             |                  |             |
|------------------|---------------|-------------------------|-------|-----------------|---------------------------------|-------------|------------------|-------------|
|                  |               |                         |       |                 | V/f Control                     | V/f with PG | Open Loop Vector | Flux Vector |
| E1-01            | Input Voltage | 155 to 255 (310 to 510) | VAC   | 200 (400)       | Quick-start, Basic, or Advanced |             |                  |             |

**Note** The setting range, or the default settings and in indicated in parentheses and indicate values for the 400-V class.



- The following is a setting example for a 200-V class Inverter with an input voltage of 230 V.

| Key sequence   | Display                        | Explanation  |
|--|--------------------------------|--|
|  | ** Main Menu **<br>Operation   | Displays initialize mode.  |
|           | ** Main Menu **<br>Programming | Displays program mode.   |
|           | Frequency Ref Terminal         | Puts the Unit in program mode.   |
|  10 times | Input Voltage E1-01= 200 VAC   | Displays the input voltage setting display.  |
|           | Input Voltage 200 VAC          | Press to change data. (The leading digit will flash).  |
|           | Input Voltage 200 VAC          | Causes the + to flash.   |
|  3 times  | Input Voltage 230 VAC          | Set to "3"   |
|           | Entry Accepted                 | The set values are overwritten. "Entry Accepted" is displayed for approximately 0.5 seconds. |
|  | Input Voltage E1-01= 230 VAC   | Returns to the input voltage display. Check that the data has been updated.                  |
|           | ** Main Menu **<br>Programming | Returns to the program mode display.   |

### ■ Setting the Power Supply Voltage Short Pin (400-V Class Inverter of 18.5 kW or More)

Set the power supply voltage short pin when setting the parameter (E1-01). Insert the short pin into the voltage connector nearest to the actual power supply voltage.

It is factory-set to the 440-V connector when shipped.

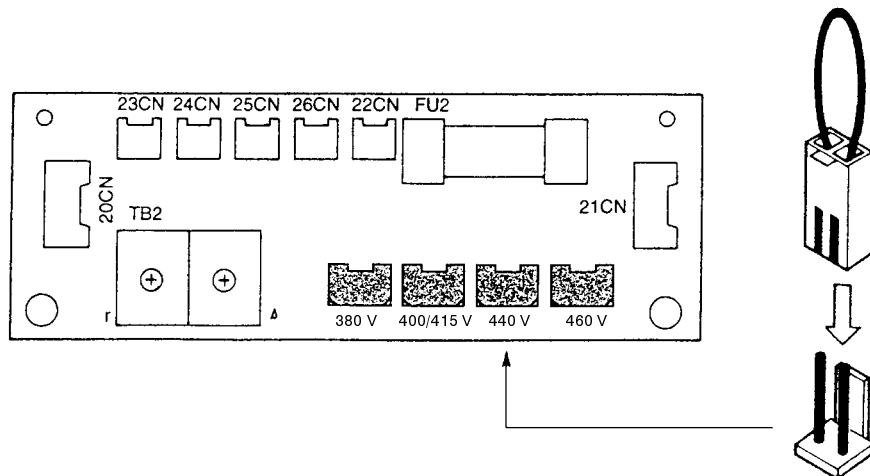

**Note 1.** The above figure is the 400-V class Inverter (18.5 to 45 kW).

**Note 2.** Be sure to turn off the power supply switch and wait for at least one minute (three minutes for models larger than 30 kW) before removing the front panel and setting the pin.

### 4-2-5 Auto-tuning

#### ■ Auto-tuning Operation

- Execute auto-tuning and the motor constants are set automatically.

| Key sequence | Display   | Explanation  |
|--------------|---|--|
|              | ** Main Menu **<br>Programming  | Displays program mode  |
|              | ** Main Menu **<br>Auto-Tuning  | Displays auto-tuning mode.   |
|              | Rated Voltage<br>200.0 VAC  | Displays the rated voltage. (see note)   |
|              | Rated Current<br>1.90A  | Displays the rated current. (see note)   |
|              | Rated Frequency<br>60.0 HZ  | Displays the rated frequency. (see note)   |
|              | Rated Speed<br>1750 RPM   | Displays the rated speed. (see note)   |
|              | Number of Poles<br>4  | Displays the number of poles. (see note)   |
|              | Select Motor 1/2<br>1   | Displays the motor selection.<br>(Selections other than "1" can't be made.)                            |
|              | Tuning Ready ?<br>Press RUN key   | Displays a confirmation prompt for the start of the auto-tuning function. (The lower line will flash.) |
|              | Tune Proceeding<br><input type="checkbox"/> HZ <input type="checkbox"/> A | Starts the auto-tuning function.<br>(The upper line will flash.)                                       |
|              | Tune Successful   | Indicates the completion of auto-tuning.   |
|              | ** Main Menu **<br>Operation  | Returns to the operation mode display.   |

**Note** When the values displayed and the motor constants differ, set each value separately. The setting method is as follows. (An operation example for changing the motor constant current to 1.60 A.

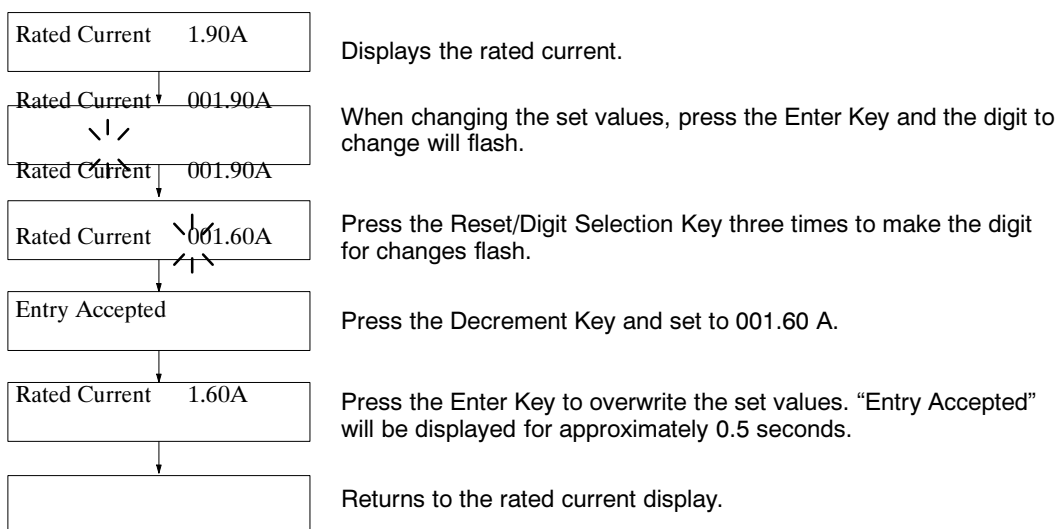

- When auto-tuning has been executed correctly, the constants (E1-01 to E2-08) will be automatically overwritten.

### ■ Setting the V/f Pattern

- When auto-tuning has not been executed correctly (i.e., when “Tune Aborted” is displayed), switch the control mode to “V/f control” and set the V/f pattern.
- Procedure for changing the control mode.

| Key sequence | Display                         | Explanation  |
|--------------|---------------------------------|--|
|              | ** Main Menu ** Operation       | Displays operation mode.   |
|              | ** Main Menu ** Initialize      | Displays initialize mode.  |
|              | Select Language English         | Puts the Unit in initialize mode. (Select Language display)      |
| 2 times      | Control Method Open Loop Vector | Press the Up Arrow Key and the control mode select is displayed. |
|              | A1-02= 2 Open Loop Vector       | Control mode select (A1-02) is displayed.                        |
| 2 times      | A1-02= 0<br>V/f Control         | Selects open-loop vector control.                                |
|              | Entry Accepted                  | The set values are overwritten.                                  |
|              | Control Method<br>V/f Control   | Returns to the control mode select display.                      |
|              | ** Main Menu ** Operation       | Returns to the operation mode display.                           |

- Set the control mode to “V/f control,” and then set the following three items. These parameters cannot be changed during operation.

| Parameter number | Display name | Setting range                  | Units | Default setting  | Valid access levels             |             |                  |             |
|------------------|--------------|--------------------------------|-------|------------------|---------------------------------|-------------|------------------|-------------|
|                  |              |                                |       |                  | V/f Control                     | V/f with PG | Open Loop Vector | Flux Vector |
| E1-05            | Max Voltage  | 0.0 to 255.0<br>(0.0 to 510.0) | VAC   | 200.0<br>(400.0) | Quick-start, Basic, or Advanced |             |                  |             |

| Parameter number | Display name   | Setting range | Units | Default setting | Valid access levels             |             |                  |             |
|------------------|----------------|---------------|-------|-----------------|---------------------------------|-------------|------------------|-------------|
|                  |                |               |       |                 | V/f Control                     | V/f with PG | Open Loop Vector | Flux Vector |
| E1-06            | Base Frequency | 0.0 to 400.0  | Hz    | 60.0            | Quick-start, Basic, or Advanced |             |                  |             |

| Parameter number | Display name    | Setting range              | Units | Default setting | Valid access levels             |             |                  |             |
|------------------|-----------------|----------------------------|-------|-----------------|---------------------------------|-------------|------------------|-------------|
|                  |                 |                            |       |                 | V/f Control                     | V/f with PG | Open Loop Vector | Flux Vector |
| E2-01            | Motor Rated FLA | 10 to 200%<br>(See note 1) | A     | See note 2      | Quick-start, Basic, or Advanced |             |                  |             |

**Note 1.** Inverter rated current ratio.

**Note 2.** The default setting for rated current differs according to the type of Inverter.







- Check the values on the motor nameplate and set each of the parameters.

E1-05 Maximum voltage (VMAX): Sets the motor rated voltage.

E1-06 Base frequency (FA): Sets the motor rated frequency.

E2-01 Motor rated FLA: Sets the motor rated current.

- The setting procedure for these three parameters is as follows.

| Key sequence   | Display                          | Explanation   |
|--|----------------------------------|---|
|  | ** Main Menu **<br>Operation     | Displays operation mode.  |
|  2 times  | ** Main Menu **<br>Programming   | Displays program mode.  |
|           | Reference Source<br>Terminal     | Puts the Unit in program mode.                                    |
|  14 times | Max Voltage<br>E1-05= 200.0 V    | Press the Up Arrow Key to display the maximum voltage. (see note) |
|           | Base Frequency<br>E1-06= 60.0 HZ | Displays the maximum voltage frequency. (see note)                |
|  5 times  | Motor Rated FLA<br>E2-01= 1.90 A | Press the Up Arrow Key to display the rated current. (see note)   |
|           | ** Main Menu **<br>Operation     | Returns to the operation mode display.                            |







**Note** When there are discrepancies between the displayed values and the rated values, set each value separately.

### 4-2-6 No-load Operation

- Operate the Digital Operator in with the motor in the no-load state (not connected to the mechanical system).

#### ■ Setting the Frequency Reference

- Set the frequency reference on the frequency reference monitor in the operation mode.
- The following is an operation example with the frequency reference set to 10 Hz.

| Key sequence  | Display                         | Explanation   |
|---|---------------------------------|---|
|   | ** Main Menu **<br>Operation    | Displays operation mode.  |
|          | Frequency Ref<br>U1-01= 0.00 HZ | Puts the Unit in operation mode and displays the frequency reference.               |
|          | Frequency Ref<br>U1-01= 6.00 HZ | Switches operation to the Digital Operator. (SEQ, REF and LED indicators turn OFF.) |
|          | Frequency Ref<br>006.00 HZ      | Sets the frequency reference.   |
|  2 times | Frequency Ref<br>006.00 HZ      | The first position flashes.   |
|  4 times | Frequency Ref<br>010.00 HZ      | Set to 010.00 Hz.   |
|          | Entry Accepted                  | The set values are overwritten.   |
|   | Frequency Ref<br>010.00 HZ      | Returns to the frequency reference display.   |

#### ■ Operation Using the Digital Operator

- Press the Run Key. The motor will start to rotate. (forward rotation)
- Press the Forward/Reverse Key. The motor will rotate in the reverse direction.

- Press the Stop Key. The motor will stop. (The operation LED indicator will keep flashing until the motor stops.)
- The frequency reference can be changed, even during operation. When this is done, the frequency reference is changed as soon as the Enter Key is pressed to input the set values.
- If the Jog Key is pressed when the Unit is stopped, it will rotate by the jog frequency (default setting: 6.0 Hz) only while the Key is being pressed.

### ■ **Checking the Operating Status**

- After changing the frequency reference or the rotation direction, check that there is no vibration or abnormal sound from the motor.
- Check that no faults have occurred in the Inverter during operation.

## **4-2-7 Actual Load Operation**

- After checking the operation with the motor in no-load status, connect the mechanical system and operate with an actual load.

### ■ **Connecting the System**

- After confirming that the motor has stopped completely, connect the mechanical system.
- Be sure to tighten all the screws when fixing the motor axis in the mechanical system.

### ■ **Operation using the Digital Operator**

- In case a fault occurs during operation, make sure the Stop Key on the Digital Operator is easily accessible.
- Use the Digital Operator in the same way as no-load operation.
- First set the frequency reference to a low speed of one tenth the normal operating speed.

### ■ **Checking Operating Status**

- Having checked that the operating direction is correct and that the machine is operating smoothly at slow speed, increase the frequency reference.
- After changing the frequency reference or the rotation direction, check that there is no vibration or abnormal sound from the motor. Check the monitor display to ensure that the U1-03 (output current) is not becoming excessive.

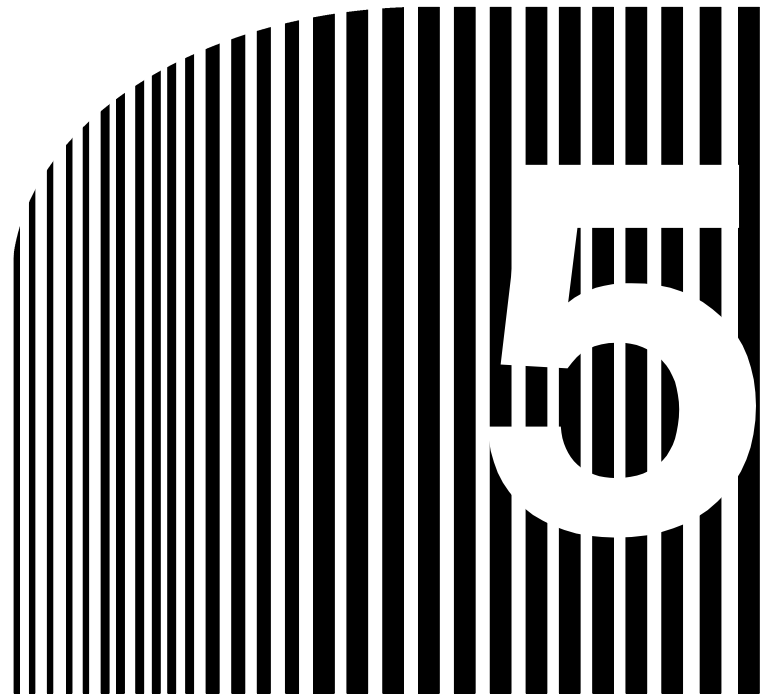

## Chapter 5

### • Basic Operation •

- 5-1 Common Settings
- 5-2 Open-loop Vector Control
- 5-3 V/f Control
- 5-4 Flux Vector Control
- 5-5 V/f Control with PG

This section explains the basic settings required to operate and stop the Inverter. The parameter settings described here will be sufficient for simple Inverter operations. After the basic settings common to all of the control modes are introduced, the basic settings specific to each control mode will be explained. Read the common settings first and then skip to the explanation for the control mode that will be used. Even when your application requires special functions such as torque control or PID control, make these basic settings first and then skip to the explanations of those special functions. (Refer to *Chapter 6 Advanced Operation*.)

## 5-1 Common Settings

### 5-1-1 Setting the Access Level and Control Mode

#### ■ Setting the Access Level (A1-01)

Parameter A1-01 is used to select the parameter access level. This level determines which parameters can be displayed and changed. This parameter can be changed during operation.

| Parameter number | Display name | Setting range | Units | Default setting | Valid access levels             |             |                  |             |
|------------------|--------------|---------------|-------|-----------------|---------------------------------|-------------|------------------|-------------|
|                  |              |               |       |                 | V/f Control                     | V/f with PG | Open Loop Vector | Flux Vector |
| A1-01            | Access Level | 0 to 4        | ---   | 2               | Quick-start, Basic, or Advanced |             |                  |             |

#### Access Level Settings



The control mode setting also affects which parameters can be displayed and changed.





| Setting | Name           | Function  |
|---------|----------------|---|
| 0       | Operation Only | This setting allows the operation mode and initialize mode to be displayed or changed. Use this setting to prevent parameter settings from being changed.                         |
| 1       | User Program   | This setting allows only the user-selected parameters (up to 32) to be displayed or changed. Select the desired parameters as “User Constants” in parameters A2-01 through A2-32. |
| 2       | Quick-start    | This setting allows the parameters required to start the Inverter (about 25) to be displayed or changed.  |
| 3       | Basic          | This setting allows the commonly used parameters to be displayed or changed.  |
| 4       | Advanced       | This setting allows all parameters to be displayed or changed.  |

**Note** The parameters required for basic operation can be displayed and changed in the Basic level, but this section also describes parameters that can be set only in the Advanced level, so set the access level to Advanced.

#### Example

The following example shows how to change parameter A1-01 from Quick-start to Advanced.

| Key sequence  | Display                       | Explanation               |
|---|-------------------------------|---------------------------|
|  | ** Main Menu **<br>Operation  | Displays operation mode.  |
|  | ** Main Menu **<br>Initialize | Displays initialize mode. |

| Key sequence  | Display                        | Explanation  |
|---|--------------------------------|--|
|          | Select Language<br>English     | Puts the Unit in initialize mode.<br>(Select Language display) |
|          | Access Level<br>Quick Start    | Displays the Access Level (A1-01).                             |
|          | A1-01= 2 ***<br>Quick-Start    | Displays the parameter setting for A1-01.                      |
|  2 times | A1-01= 4<br>Advanced           | Changes the setting to Advanced.                               |
|          | Entry Accepted                 | Writes the new setting.  |
|   | Access Level<br>Advanced Level | Returns to the Access Level display.                           |

■ **Setting the Control Mode (A1-02)**

Parameter A1-02 is used to select one of the four control modes. This parameter is not initialized by the initialize operation and it cannot be changed during operation.

| Parameter number | Display name   | Setting range | Units | Default setting | Valid access levels             |             |                  |             |
|------------------|----------------|---------------|-------|-----------------|---------------------------------|-------------|------------------|-------------|
|                  |                |               |       |                 | V/f Control                     | V/f with PG | Open Loop Vector | Flux Vector |
| A1-02            | Control Method | 0 to 3        | ---   | 2               | Quick-start, Basic, or Advanced |             |                  |             |

**Control Mode Settings**

| Setting | Name             | Function   |
|---------|------------------|--|
| 0       | V/f Control      | V/f control without pulse generator (normal V/f control)   |
| 1       | V/f w/PG Fdbk    | V/f control with pulse generator (V/f control using a PG Speed Control Card)                               |
| 2       | Open Loop Vector | Vector control without pulse generator<br>(Vector control using the Inverter’s internal speed information) |
| 3       | Flux Vector      | Vector control with pulse generator<br>(Vector control using a PG Speed Control Card)                      |



**Control Mode Characteristics**

| Characteristic           | V/f Control   | V/f w/PG Fdbk   | Open Loop Vector  | Flux Vector  |
|--------------------------|---|---|---|--|
| Basic control method     | Voltage/frequency control (open loop)                             | Voltage/frequency control with speed compensation                               | Current vector control without PG   | Current vector control with PG   |
| Speed detector           | Not required  | Required (pulse generator)  | Not required  | Required (pulse generator)   |
| Optional Speed Detectors | Not required  | 3G3FV-PPGA2 or 3G3FV-PPGD2  | Not required  | 3G3FV-PPGB2 or 3G3FV-PPGX2   |
| Speed control range      | 1:40  | 1:40  | 1:100   | 1:1,000  |
| Starting torque          | 150%/3 Hz   | 150%/3 Hz   | 150%/1 Hz   | 150%/0 Hz  |
| Speed control precision  | ±2 to 3%  | ±0.03%  | ±0.2%   | ±0.02%   |
| Torque limit             | Not possible  | Not possible  | Possible  | Possible   |
| Torque control           | Not possible  | Not possible  | Not possible  | Possible   |
| Example applications     | <ul style="list-style-type: none"> <li>Multiple motors</li> </ul> | <ul style="list-style-type: none"> <li>Simple speed feedback control</li> </ul> | <ul style="list-style-type: none"> <li>Variable speed drive applications</li> </ul> | <ul style="list-style-type: none"> <li>Simple servo drives</li> <li>Precision speed control</li> <li>Torque control</li> </ul> |

**Note** Vector control has a greater starting torque and more precise speed control than V/f control, so use of vector control is recommended whenever possible. Use V/f control in the following types of applications:

- When several motors are being operated
- When special motors such as submersible motors or spindle motors are being used (Situations in which auto-tuning cannot be used.)
- When operation is being coordinated with an older inverter control system

### 5-1-2 Frequency Reference Settings from Control Circuit Terminals

These settings are required when inputting analog voltage or current signals from the control circuit terminals.

#### ■ Frequency Reference Selection (b1-01)

Parameter b1-01 is used to select the reference source; it cannot be changed during operation.

| Parameter number | Display name     | Setting range | Units | Default setting | Valid access levels             |             |                  |             |
|------------------|------------------|---------------|-------|-----------------|---------------------------------|-------------|------------------|-------------|
|                  |                  |               |       |                 | V/f Control                     | V/f with PG | Open Loop Vector | Flux Vector |
| b1-01            | Reference Source | 0 to 3        | ---   | 1               | Quick-start, Basic, or Advanced |             |                  |             |

#### Reference Source Settings

| Setting | Name       | Reference source                          |
|---------|------------|---|
| 0       | Operator   | Digital Operator                          |
| 1       | Terminals  | Control circuit terminals (analog inputs) |
| 2       | Serial Com | Not used. (Do not set this value.)        |
| 3       | Option PCB | Optional Card                             |

**Note** The frequency reference is input from the control circuit terminals (external terminals), so set b1-01 to 1.

■ **Frequency Reference: Terminal 13 Voltage Input (H3-01)**

The frequency reference (voltage) is valid when parameter b1-01 has been set to 1. Parameter H3-01 is used to set the voltage range for the frequency reference (voltage) signal. This parameter cannot be changed during operation.

| Parameter number | Display name   | Setting range | Units | Default setting | Valid access levels |             |                  |             |
|------------------|----------------|---------------|-------|-----------------|---------------------|-------------|------------------|-------------|
|                  |                |               |       |                 | V/f Control         | V/f with PG | Open Loop Vector | Flux Vector |
| H3-01            | Term 13 Signal | 0 or 1        | ---   | 0               | Basic or Advanced   |             |                  |             |

**Terminal 13 Signal Level Settings**

| Setting | Name          | Function   |
|---------|---------------|--|
| 0       | 0 to 10 VDC   | 0 to 10 VDC input  |
| 1       | -10 to 10 VDC | -10 to 10 VDC input<br>(A negative voltage is a command for rotation in the opposite direction.) |

■ **Frequency Reference: Terminal 14 Current Input (H3-08 and H3-09)**

Terminal 14 must be set to “frequency reference” with parameter H3-09 in order to use terminal 14 as the frequency reference terminal; the “frequency reference” setting is 1F. Neither H3-08 nor H3-09 can be changed during operation.

| Parameter number | Display name    | Setting range | Units | Default setting | Valid access levels |             |                  |             |
|------------------|-----------------|---------------|-------|-----------------|---------------------|-------------|------------------|-------------|
|                  |                 |               |       |                 | V/f Control         | V/f with PG | Open Loop Vector | Flux Vector |
| H3-09            | Terminal 14 Sel | 1 to 1F       | ---   | 1F              | Advanced            |             |                  |             |

After setting parameter H3-09, set terminal 14’s signal level with H3-08. The frequency reference (current) is valid when parameter b1-01 has been set to 1.

| Parameter number | Display name   | Setting range | Units | Default setting | Valid access levels |             |                  |             |
|------------------|----------------|---------------|-------|-----------------|---------------------|-------------|------------------|-------------|
|                  |                |               |       |                 | V/f Control         | V/f with PG | Open Loop Vector | Flux Vector |
| H3-08            | Term 14 Signal | 0 to 2        | ---   | 2               | Advanced            |             |                  |             |

**Terminal 14 Signal Level Settings**

| Setting | Name          | Function   |
|---------|---------------|--|
| 0       | 0 to 10 VDC   | 0 to 10 VDC input  |
| 1       | -10 to 10 VDC | -10 to 10 VDC input<br>(A negative voltage is a command for rotation in the opposite direction.) |
| 2       | 4 to 20 mA    | 4 to 20 mA input   |

**Note** When the terminal is being used as a voltage input terminal (setting 0 or 1), jumper J1 must be disconnected on the control board. (See the following diagram.) The terminal’s input resistor will be destroyed if the terminal is used for a voltage input with jumper J1 connected.

- When frequency references are being input simultaneously from both the voltage terminal 13 and the current terminal 14, the final reference value will be the sum of the two references that are input.

- To switch the frequency reference input between the voltage terminal 13 and the current terminal 14, set a value of 1F in any one of the multi-function inputs (H1-01 through H1-06). The voltage terminal 13 will be used when this multi-function input is OFF and the current terminal 14 will be used when this multi-function input is ON.
- The following diagram shows the location of jumper J1 on a 200-V Class, 0.4-kW Unit.

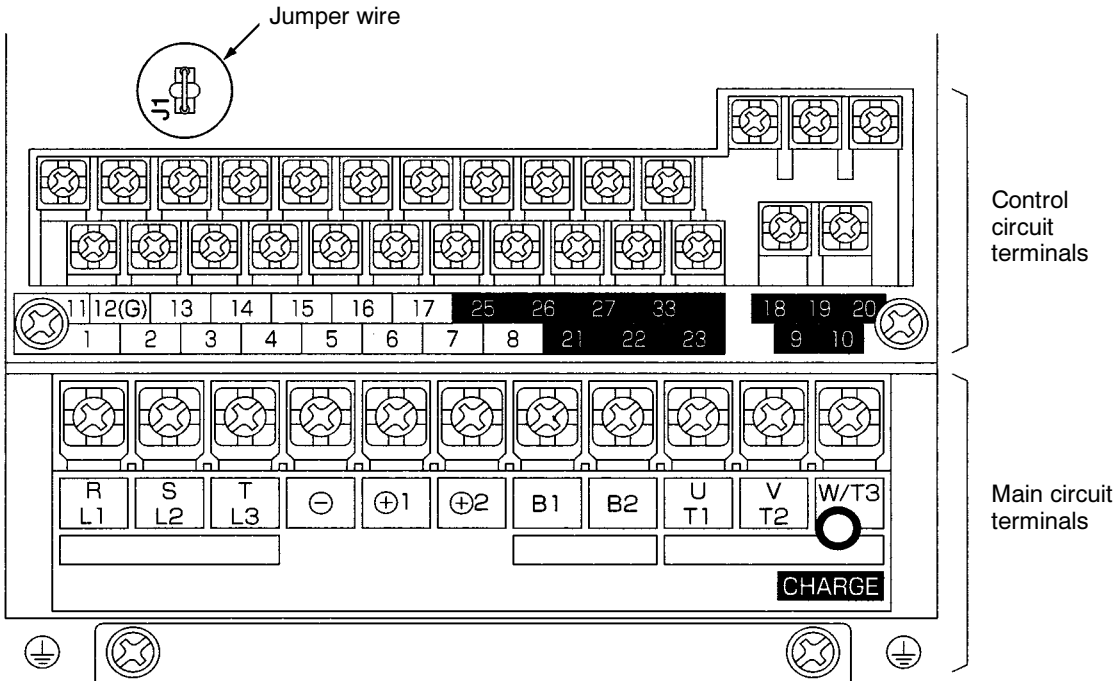

■ Frequency Reference: Terminal 16 Voltage Input (H3-04 and H3-05)

This function is useful when switching between two analog inputs. When using this multi-function input (terminal 16) as the frequency reference terminal, first set the multi-function analog input’s function to “Auxiliary Reference” by setting parameter H3-05 to “0.” (Neither H3-04 nor H3-05 can be changed during operation.)

| Parameter number | Display name    | Setting range | Units | Default setting | Valid access levels |             |                  |             |
|------------------|-----------------|---------------|-------|-----------------|---------------------|-------------|------------------|-------------|
|                  |                 |               |       |                 | V/f Control         | V/f with PG | Open Loop Vector | Flux Vector |
| H3-05            | Terminal 16 Sel | 0 to 1F       | ---   | 1F              | Basic or Advanced   |             |                  |             |

After setting H3-05 to “0,” set any one of the multi-function inputs (H1-01 through H1-06) to a value of 3 (Multi-step Reference 1). When a multi-function analog input has been set to “Auxiliary Reference,” it is treated as “frequency reference 2” during multi-step operation, so it can’t be used unless Multi-step Reference 1 has been set.

Set terminal 16’s signal level with H3-04.

| Parameter number | Display name   | Setting range | Units | Default setting | Valid access levels |             |                  |             |
|------------------|----------------|---------------|-------|-----------------|---------------------|-------------|------------------|-------------|
|                  |                |               |       |                 | V/f Control         | V/f with PG | Open Loop Vector | Flux Vector |
| H3-04            | Term 16 Signal | 0 or 1        | ---   | 0               | Basic or Advanced   |             |                  |             |

**Terminal 16 Signal Level Settings**

| Setting | Name          | Function   |
|---------|---------------|--|
| 0       | 0 to 10 VDC   | 0 to 10 VDC input  |
| 1       | -10 to 10 VDC | -10 to 10 VDC input<br>(A negative voltage is a command for rotation in the opposite direction.) |

■ **Adjusting the Analog Inputs**

There are three parameters used to adjust the analog inputs: the gain and bias (set separately for each input) and the filter time constant (a single value for all of the inputs).

The gain and bias can be adjusted separately for each analog input (terminals 13, 14, and 16).

- **Gain:** Set the frequency corresponding to a 10 V (20 mA) input as a percentage of the maximum. (The maximum frequency set in E1-04 is 100%.)
- **Bias:** Set the frequency corresponding to a 0 V (4 mA) input as a percentage of the maximum. (The maximum frequency set in E1-04 is 100%.)

Set terminal 13's gain and bias with H3-02 and H3-03. (Both settings can be changed during operation.)

| Parameter number | Display name     | Setting range   | Units | Default setting | Valid access levels |             |                  |             |
|------------------|------------------|-----------------|-------|-----------------|---------------------|-------------|------------------|-------------|
|                  |                  |                 |       |                 | V/f Control         | V/f with PG | Open Loop Vector | Flux Vector |
| H3-02            | Terminal 13 Gain | 0.0 to 1,000.0  | %     | 100.0           | Basic or Advanced   |             |                  |             |
| H3-03            | Terminal 13 Bias | -100.0 to 100.0 | %     | 0.0             | Basic or Advanced   |             |                  |             |

Set terminal 14's gain and bias with H3-10 and H3-11. (Both settings can be changed during operation.)

| Parameter number | Display name     | Setting range   | Units | Default setting | Valid access levels |             |                  |             |
|------------------|------------------|-----------------|-------|-----------------|---------------------|-------------|------------------|-------------|
|                  |                  |                 |       |                 | V/f Control         | V/f with PG | Open Loop Vector | Flux Vector |
| H3-10            | Terminal 14 Gain | 0.0 to 1,000.0  | %     | 100.0           | Advanced            |             |                  |             |
| H3-11            | Terminal 14 Bias | -100.0 to 100.0 | %     | 0.0             | Advanced            |             |                  |             |

Set terminal 16's gain and bias with H3-06 and H3-07. (Both settings can be changed during operation.)

| Parameter number | Display name     | Setting range   | Units | Default setting | Valid access levels |             |                  |             |
|------------------|------------------|-----------------|-------|-----------------|---------------------|-------------|------------------|-------------|
|                  |                  |                 |       |                 | V/f Control         | V/f with PG | Open Loop Vector | Flux Vector |
| H3-06            | Terminal 16 Gain | 0.0 to 1,000.0  | %     | 100.0           | Basic or Advanced   |             |                  |             |
| H3-07            | Terminal 16 Bias | -100.0 to 100.0 | %     | 0.0             | Basic or Advanced   |             |                  |             |

Gain and Bias Chart

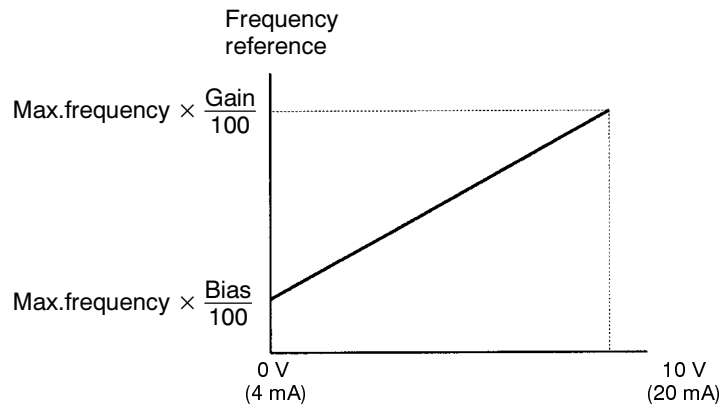

**Note** Use the current values shown in parentheses when current input has been selected.

The first-order lag's digital filter can be set for all three analog inputs (frequency reference (voltage), frequency reference (current), and multi-function analog input) with parameter H3-12. This setting is effective when there are sudden changes or noise in the analog input signal. Responsiveness decreases as the setting increases.

The filter time constant cannot be changed during operation.

| Parameter number | Display name    | Setting range | Units | Default setting | Valid access levels |             |                  |             |
|------------------|-----------------|---------------|-------|-----------------|---------------------|-------------|------------------|-------------|
|                  |                 |               |       |                 | V/f Control         | V/f with PG | Open Loop Vector | Flux Vector |
| H3-12            | Filter Avg Time | 0.00 to 2.00  | s     | 0.00            | Advanced            |             |                  |             |

### 5-1-3 Frequency Reference Settings from Digital Operator

#### ■ Selecting the Frequency Reference Source (b1-01)

Parameter b1-01 is used to select the reference source; it cannot be changed during operation.

| Parameter number | Display name     | Setting range | Units | Default setting | Valid access levels             |             |                  |             |
|------------------|------------------|---------------|-------|-----------------|---------------------------------|-------------|------------------|-------------|
|                  |                  |               |       |                 | V/f Control                     | V/f with PG | Open Loop Vector | Flux Vector |
| b1-01            | Reference Source | 0 to 3        | ---   | 1               | Quick-start, Basic, or Advanced |             |                  |             |

#### Reference Source Settings

| Setting | Name       | Reference source                          |
|---------|------------|---|
| 0       | Operator   | Digital Operator                          |
| 1       | Terminals  | Control circuit terminals (analog inputs) |
| 2       | Serial Com | Not used. (Do not set this value.)        |
| 3       | Option PCB | Optional Card                             |

**Note** The frequency reference is input from the Digital Operator, so set b1-01 to 0.

■ **Setting the Frequency Reference Units (o1-03)**

Parameter o1-03 is used to set the units for setting and displaying the frequency reference; it cannot be changed during operation.

| Parameter number | Display name    | Setting range | Units | Default setting | Valid access levels |             |                  |             |
|------------------|-----------------|---------------|-------|-----------------|---------------------|-------------|------------------|-------------|
|                  |                 |               |       |                 | V/f Control         | V/f with PG | Open Loop Vector | Flux Vector |
| o1-03            | Display Scaling | 0 to 39,999   | ---   | 0               | Basic or Advanced   |             |                  |             |

**Display Unit Settings**

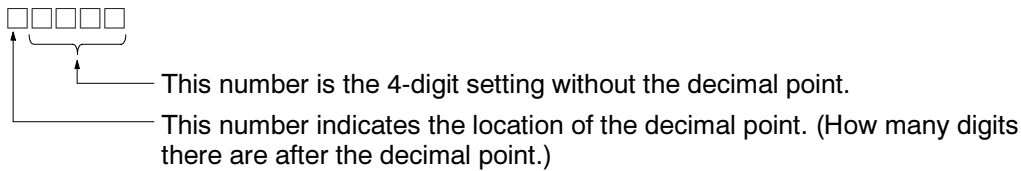
| Setting      | Function  |
|--------------|---|
| 0            | 0.01 Hz units   |
| 1            | 0.01 % units (The maximum frequency is 100%.)   |
| 2 to 39      | r/min units (Set the number of poles. This setting can't be used with Flux Vector control.)   |
| 40 to 39,999 | <p>Sets a particular value for the maximum frequency.</p>  <p>For example, set o1-03 to “12000” when you want to display “200.0” for the maximum frequency.</p> |

**Note** When the 40 to 39,999 range is used, any scale can be set for the reference frequency. For example, the frequency reference can be set or displayed in units such as mm/s or m/min to coincide with a machine’s linear operating speed.

■ **Presetting Frequency Reference Values (d1-01 through d1-09)**

Parameters d1-01 through d1-08 contain preset reference values 1 through 8. The setting range for all of the values is 0 to the max. frequency. These 8 parameters can be changed during operation.

| Parameter number | Display name | Setting range | Units | Default setting | Valid access levels             |             |                  |             |
|------------------|--------------|---------------|-------|-----------------|---------------------------------|-------------|------------------|-------------|
|                  |              |               |       |                 | V/f Control                     | V/f with PG | Open Loop Vector | Flux Vector |
| d1-01            | Reference 1  | 0 to max.     | o1-03 | 6.00 Hz         | Quick-start, Basic, or Advanced |             |                  |             |
| d1-02            | Reference 2  | 0 to max.     | o1-03 | 0.00 Hz         | Quick-start, Basic, or Advanced |             |                  |             |
| d1-03            | Reference 3  | 0 to max.     | o1-03 | 0.00 Hz         | Quick-start, Basic, or Advanced |             |                  |             |
| d1-04            | Reference 4  | 0 to max.     | o1-03 | 0.00 Hz         | Quick-start, Basic, or Advanced |             |                  |             |
| d1-05            | Reference 5  | 0 to max.     | o1-03 | 0.00 Hz         | Basic or Advanced               |             |                  |             |
| d1-06            | Reference 6  | 0 to max.     | o1-03 | 0.00 Hz         | Basic or Advanced               |             |                  |             |
| d1-07            | Reference 7  | 0 to max.     | o1-03 | 0.00 Hz         | Basic or Advanced               |             |                  |             |
| d1-08            | Reference 8  | 0 to max.     | o1-03 | 0.00 Hz         | Basic or Advanced               |             |                  |             |

- Note 1.** The units for these values are set in o1-03.
- Note 2.** The frequency reference’s initial value and set value will change when o1-03 is changed. For example, if preset reference 1 is set to 6.00 Hz and o1-03 is changed to 1 (0.01% units), the setting for preset reference 1 will become 10.00%.
- Note 3.** When using preset references 2 through 8, be sure to set Multi-Step Reference 1, 2, and 3 in the multi-function inputs (H1-01 through H1-06) as required.

When using the Jog function, set the jog frequency reference in parameter d1-09. The setting range for this value is 0 to the max. frequency. This parameter can be changed during operation.

| Parameter number | Display name  | Setting range | Units | Default setting | Valid access levels             |             |                  |             |
|------------------|---------------|---------------|-------|-----------------|---------------------------------|-------------|------------------|-------------|
|                  |               |               |       |                 | V/f Control                     | V/f with PG | Open Loop Vector | Flux Vector |
| d1-09            | Jog Reference | 0 to max.     | o1-03 | 6.00 Hz         | Quick-start, Basic, or Advanced |             |                  |             |

**Note 1.** When performing the Jog operation from an external terminal, set the multi-function inputs (H1-01 through H1-06) to “Jog Frequency Reference,” “Forward Jog,” or “Reverse Jog” as required.

**Note 2.** The multi-function input setting is unnecessary when performing the Jog operation from the Operator.

### 5-1-4 Run Source and Responsiveness Settings

#### ■ Selecting the Run Source (b1-02)

Parameter b1-02 is used to select the source of the run command; it cannot be changed during operation. When a control circuit terminal (external terminal) is set, the Unit operates with 2-wire forward/stop and reverse/stop control. (When the Unit has been initialized for a 3-wire control or a multi-function input is set to “0” (3-wire control), the Unit operates with 3-wire run, stop and forward/reverse control.)

| Parameter number | Display name | Setting range | Units | Default setting | Valid access levels             |             |                  |             |
|------------------|--------------|---------------|-------|-----------------|---------------------------------|-------------|------------------|-------------|
|                  |              |               |       |                 | V/f Control                     | V/f with PG | Open Loop Vector | Flux Vector |
| b1-02            | Run Source   | 0 to 3        | ---   | 1               | Quick-start, Basic, or Advanced |             |                  |             |

#### Run Source Settings

| Setting | Name       | Run source                                     |
|---------|------------|--|
| 0       | Operator   | Digital Operator                               |
| 1       | Terminals  | Control circuit terminals (external terminals) |
| 2       | Serial Com | Not used. (Do not set these values.)           |
| 3       | Option PCB |  |

#### ■ Setting Control Input Responsiveness (b1-06)

Parameter b1-06 is used to set the responsiveness of the control inputs (forward/reverse and multi-function inputs); it cannot be changed during operation.

| Parameter number | Display name     | Setting range | Units | Default setting | Valid access levels |             |                  |             |
|------------------|------------------|---------------|-------|-----------------|---------------------|-------------|------------------|-------------|
|                  |                  |               |       |                 | V/f Control         | V/f with PG | Open Loop Vector | Flux Vector |
| b1-06            | Cntl Input Scans | 0 or 1        | ---   | 1               | Advanced            |             |                  |             |

#### Settings

| Setting | Name          | Function  |
|---------|---------------|---|
| 0       | 2mS – 2 Scans | Two scans every 2 ms (Use when connecting transistor outputs.)          |
| 1       | 5mS – 2 Scans | Two scans every 5 ms (Use when connecting contact outputs or switches.) |

**Note** Set the responsiveness to match the type of control inputs being used. Use a setting of “1” if there is even one contact input.

## 5-1-5 Acceleration/Deceleration Time Settings

### ■ Acceleration/Deceleration Time Units (C1-10)

Parameter C1-10 is used to set the units for the acceleration and deceleration time settings in C1-01 through C1-08. Setting C1-10 to “0” allows the acceleration and deceleration times to be set very precisely, but reduces the maximum time setting from 6000.0 s to 600.00 s.

This parameter cannot be changed during operation.

| Parameter number | Display name  | Setting range | Units | Default setting | Valid access levels |             |                  |             |
|------------------|---------------|---------------|-------|-----------------|---------------------|-------------|------------------|-------------|
|                  |               |               |       |                 | V/f Control         | V/f with PG | Open Loop Vector | Flux Vector |
| C1-10            | Acc/Dec Units | 0 or 1        | ---   | 1               | Advanced            |             |                  |             |

### Settings

| Setting | Name         | Function   |
|---------|--------------|--|
| 0       | 0.01 Seconds | Sets the acceleration/deceleration time units to 0.01 seconds. |
| 1       | 0.1 Seconds  | Sets the acceleration/deceleration time units to 0.1 seconds.  |

### ■ Acceleration/Deceleration Time Settings (C1-01 through C1-08)

Parameters C1-01 through C1-08 set the acceleration and deceleration times individually.

The acceleration time is the time required to go from 0% to 100% of the maximum frequency and the deceleration time is the time required to go from 100% to 0% of the maximum frequency.

Four acceleration times and four deceleration times can be set. When using acceleration/deceleration times 2 through 4, set “Multi-Accel/Decel 1” or “Multi-Accel/Decel 2” in the multi-function inputs (H1-01 through H1-06).

| Parameter number | Display name        | Setting range (See note 1.) | Units | Default setting | Valid access levels             |             |                  |             |
|------------------|---------------------|-----------------------------|-------|-----------------|---------------------------------|-------------|------------------|-------------|
|                  |                     |                             |       |                 | V/f Control                     | V/f with PG | Open Loop Vector | Flux Vector |
| C1-01            | Acceleration time 1 | 0.0 to 6000.0               | s     | 10.0            | Quick-start, Basic, or Advanced |             |                  |             |
| C1-02            | Deceleration time 1 | 0.0 to 6000.0               | s     | 10.0            | Quick-start, Basic, or Advanced |             |                  |             |
| C1-03            | Acceleration time 2 | 0.0 to 6000.0               | s     | 10.0            | Basic or Advanced               |             |                  |             |
| C1-04            | Deceleration time 2 | 0.0 to 6000.0               | s     | 10.0            | Basic or Advanced               |             |                  |             |
| C1-05            | Acceleration time 3 | 0.0 to 6000.0               | s     | 10.0            | Advanced                        |             |                  |             |
| C1-06            | Deceleration time 3 | 0.0 to 6000.0               | s     | 10.0            | Advanced                        |             |                  |             |
| C1-07            | Acceleration time 4 | 0.0 to 6000.0               | s     | 10.0            | Advanced                        |             |                  |             |
| C1-08            | Deceleration time 4 | 0.0 to 6000.0               | s     | 10.0            | Advanced                        |             |                  |             |

**Note 1.** The setting range for the acceleration/deceleration times depends upon the setting in C1-10 (Acc/Dec Units). The table shows the setting range when the factory setting is used for C1-10. If C1-10 is set to “0,” the setting range will be 0.00 to 600.00 s.

**Note 2.** Parameters C1-01 through C1-04 can be changed during operation, but C1-05 through C1-08 cannot.

### ■ Emergency Stop Time Setting (C1-09)

Parameter C1-09 sets the deceleration time that will be used when an emergency stop signal is input or a fault is detected; it can be changed during operation. The deceleration time is the time required to go from 100% to 0% of the maximum frequency.



When using an emergency stop input, set a multi-function input (H1-01 through H1-06) to “Fast-Stop.” The emergency stop time is effective for the following faults. Set a stopping method for each.

- Inverter overheating (OH) pre-alarm: Set in L8-03.
- Pulse generator faults: Set in F1-02 through F1-04.

| Parameter number | Display name   | Setting range (See note.) | Units | Default setting | Valid access levels |             |                  |             |
|------------------|----------------|---------------------------|-------|-----------------|---------------------|-------------|------------------|-------------|
|                  |                |                           |       |                 | V/f Control         | V/f with PG | Open Loop Vector | Flux Vector |
| C1-09            | Fast Stop Time | 0.0 to 6000.0             | s     | 10.0            | Basic or Advanced   |             |                  |             |

**Note** The setting range for the emergency stop deceleration time depends upon the setting in C1-10 (Acc/Dec Units). The table shows the setting range when the factory setting is used for C1-10. If C1-10 is set to “0,” the setting range will be 0.00 to 600.00 s.

### ■ Acceleration/Deceleration Time Switching Frequency (C1-11)

When the acceleration/deceleration time switching frequency is set in C1-11, the acceleration and deceleration times will be changed automatically as the frequency passes the set level. This parameter cannot be changed during operation.

The “Multi-Accel/Decel 1” and “Multi-Accel/Decel 2” inputs will have priority when “Multi-Accel/Decel 1” and “Multi-Accel/Decel 2” have been set in the multi-function inputs (H1-01 through H1-06).

| Parameter number | Display name    | Setting range (See note.) | Units | Default setting | Valid access levels |             |                  |             |
|------------------|-----------------|---------------------------|-------|-----------------|---------------------|-------------|------------------|-------------|
|                  |                 |                           |       |                 | V/f Control         | V/f with PG | Open Loop Vector | Flux Vector |
| C1-11            | Acc/Dec SW Freq | 0.0 to 400.0              | Hz    | 0.0             | Advanced            |             |                  |             |

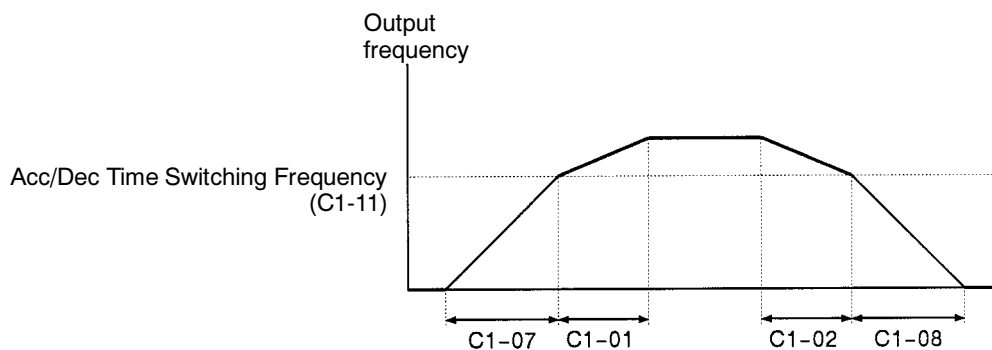

Acceleration/Deceleration Time 1 (C1-01 and C1-02) are used when the output frequency  $\geq$  C1-11  
 Acceleration/Deceleration Time 4 (C1-07 and C1-08) are used when the output frequency  $<$  C1-11

### 5-1-6 Disabling Reverse Operation (b1-04)

Parameter b1-04 is used to enable and disable reverse command inputs. This parameter can be set to “1” to disable reverse operation when necessary. This parameter cannot be changed during operation.

| Parameter number | Display name | Setting range | Units | Default setting | Valid access levels |             |                  |             |
|------------------|--------------|---------------|-------|-----------------|---------------------|-------------|------------------|-------------|
|                  |              |               |       |                 | V/f Control         | V/f with PG | Open Loop Vector | Flux Vector |
| b1-04            | Reverse Oper | 0 or 1        | ---   | 0               | Basic or Advanced   |             |                  |             |

Settings

| Setting | Name             | Function                     |
|---------|------------------|------------------------------|
| 0       | Reverse Enabled  | Allows reverse operation.    |
| 1       | Reverse Disabled | Prohibits reverse operation. |

5-1-7 Selecting the Stopping Method (b1-03)

Parameter b1-03 sets the stopping method used when a stop command is input. This parameter cannot be changed during operation.

| Parameter number | Display name    | Setting range | Units | Default setting | Valid access levels             |             |                  |             |
|------------------|-----------------|---------------|-------|-----------------|---------------------------------|-------------|------------------|-------------|
|                  |                 |               |       |                 | V/f Control                     | V/f with PG | Open Loop Vector | Flux Vector |
| b1-03            | Stopping Method | 0 to 3        | ---   | 0               | Quick-start, Basic, or Advanced |             |                  |             |

Settings

Only settings 0 and 1 can be used with Flux Vector control.

| Setting | Name                 | Function   |
|---------|----------------------|--|
| 0       | Ramp to Stop         | Deceleration stop  |
| 1       | Coast to Stop        | Free-run stop  |
| 2       | DC Injection to Stop | DC braking stop: Stops faster than free-run, without regenerative operation. |
| 3       | Coast w/Timer        | Free-run stop with timer: Run commands are ignored during deceleration time. |

The following diagrams show the operation of each stopping method. The “deceleration time” in the diagrams refers to the selected deceleration time. (Deceleration times 1 through 4 are set with C1-02, C1-04, C1-06, and C1-08.)

• Deceleration Stop (b1-03 = 0)

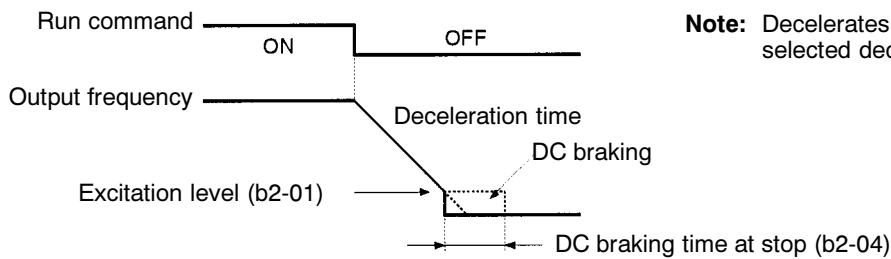

**Note:** Decelerates to a stop at a rate set with the selected deceleration time.

• Free-run Stop (b1-03 = 1)

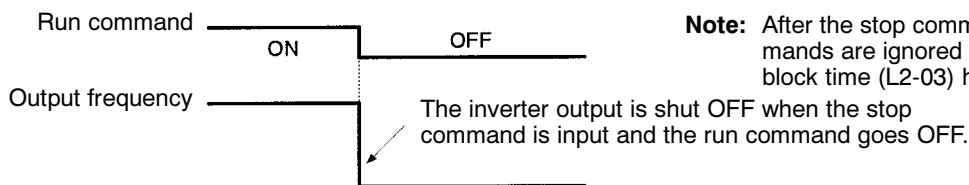

**Note:** After the stop command is input, run commands are ignored until the minimum base-block time (L2-03) has elapsed.

• DC Braking Stop (b1-03 = 2)  
(DC Injection)

**Note:** After the stop command is input and the minimum baseblock time (L2-03) has elapsed, DC braking is applied and the motor stopped. The DC braking time depends upon the output frequency when the stop command is input and the “DC braking time at stop” setting in b2-04, as shown in the graph below.

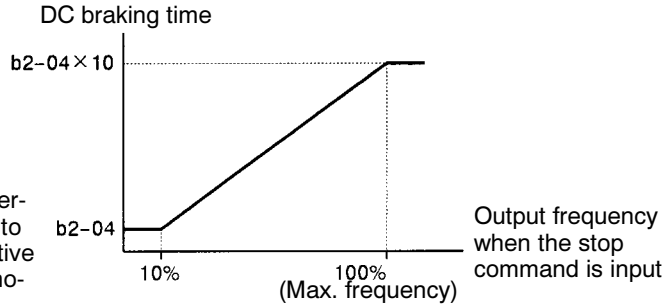
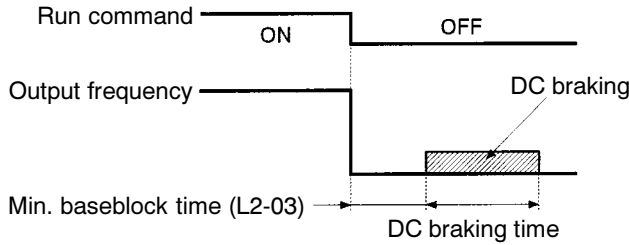

**Note:** Lengthen the min. baseblock time (L2-03) when an overcurrent (OC) occurs during stopping. When the power to an induction motor is turned off, the counter-electromotive force generated by the residual magnetic field in the motor can cause an overcurrent to be detected when DC braking is applied.

• Free-run Stop with Timer (b1-03 = 3)

**Note:** After the stop command is input, run commands are ignored until the time  $t_0$  has elapsed. The time  $t_0$  depends upon the output frequency when the stop command is input and the deceleration time.

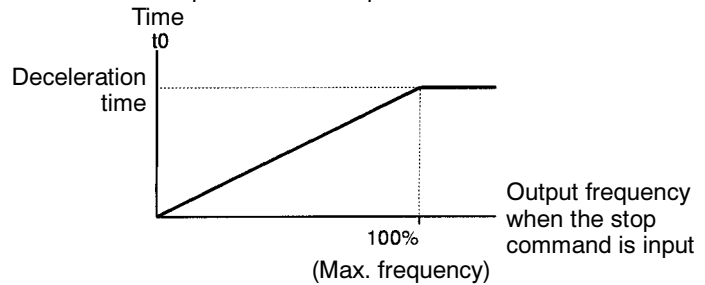
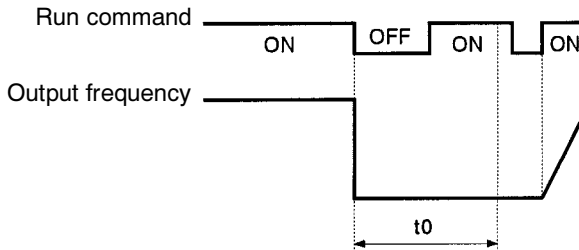

5-1-8 Multi-function Input Settings (H1-01 through H1-06)

Parameters H1-01 through H1-06 set the multi-function inputs in accordance with the application. These 6 parameters cannot be changed during operation.

| Parameter number | Display name   | Setting range | Units | Default setting (See note.) | Valid access levels |             |                  |             |
|------------------|----------------|---------------|-------|-----------------------------|---------------------|-------------|------------------|-------------|
|                  |                |               |       |                             | V/f Control         | V/f with PG | Open Loop Vector | Flux Vector |
| H1-01            | Terminal 3 Sel | 0 to 77       | ---   | 24                          | Basic or Advanced   |             |                  |             |
| H1-02            | Terminal 4 Sel | 0 to 77       | ---   | 14                          | Basic or Advanced   |             |                  |             |
| H1-03            | Terminal 5 Sel | 0 to 77       | ---   | 3 (0)                       | Basic or Advanced   |             |                  |             |
| H1-04            | Terminal 6 Sel | 0 to 77       | ---   | 4 (3)                       | Basic or Advanced   |             |                  |             |
| H1-05            | Terminal 7 Sel | 0 to 77       | ---   | 6 (4)                       | Basic or Advanced   |             |                  |             |
| H1-06            | Terminal 8 Sel | 0 to 77       | ---   | 8 (6)                       | Basic or Advanced   |             |                  |             |

**Note** The default settings in parentheses are the default values when the Unit is initialized for 3-wire sequence control with A1-03.

The parameter settings which are used most often are explained below. Refer to *Chapter 6 Advanced Operation* or the parameter tables for details on the other settings.

- Setting “0”: 3-wire Control (forward/reverse command)
- Setting “3” to “6”: Multi-step References 1 through 3 and Jog Reference
- Setting “7” and “1A”: Multi-Accel/Decel Time Selector 1 and 2
- Setting “15”: Fast-Stop (emergency stop)
- Setting “12” and “13”: Forward and Reverse Jog Commands
- Setting “1F”: Terminal 13/14 Switch

● **Setting “0”: 3-wire Control (Forward/Reverse Command)**

When a value of “0” is set for any one of the multi-function inputs (H1-01 through H1-06), 3-wire control is established and the multi-function input terminal for which “0” was set becomes the forward/reverse command terminal. When the Unit is initialized for 3-wire sequence control with A1-03 (a setting of 3330), multi-function input 3 (terminal 5) becomes the input terminal for the forward/reverse command.

**Wiring Example**

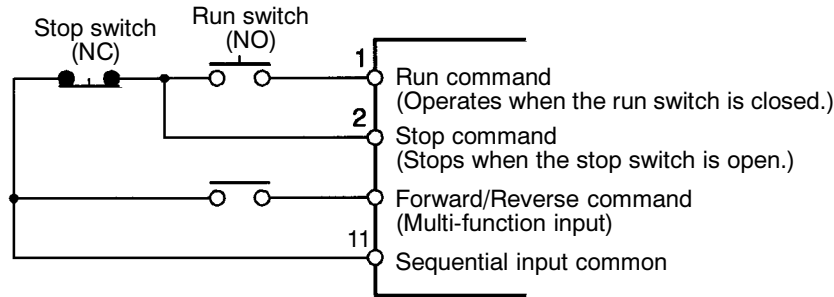

**Timing Chart**

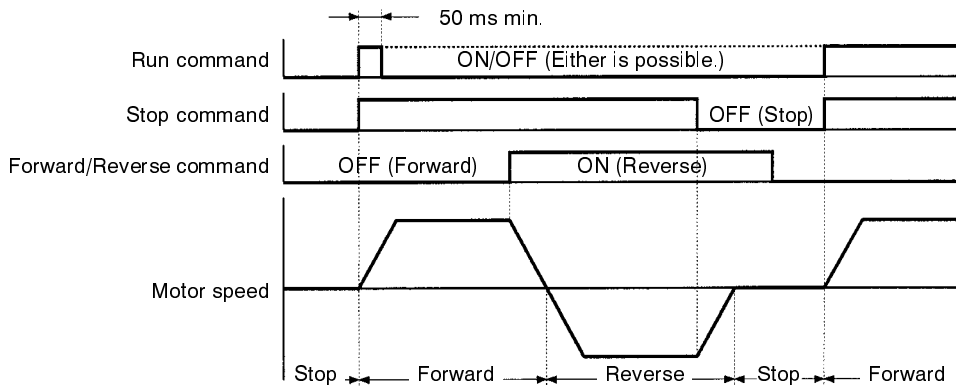

● **Setting “3” to “6”: Multi-step References 1 through 3 and Jog Reference**

Eight frequency references and one jog reference can be used in the 3G3FV. Set “Multi-step Reference 1, 2, and 3” and “Jog Frequency Reference” in multi-function inputs, and change the status of these inputs to switch between these 9 frequency references.

| Setting | Function  |
|---------|---|
| 3       | Multi-step Reference 1 (Also used for main-speed/auxiliary-speed switching when “Auxiliary Reference” is set in multi-function analog input H3-05.) |
| 4       | Multi-step Reference 2  |
| 5       | Multi-step Reference 3  |
| 6       | Jog frequency reference (This setting has higher priority than the multi-step references.)  |

The following table shows which frequency is selected by each possible combination of multi-step and jog reference settings.

| Multi-step Reference |     |     | Jog Reference | Selected frequency   |
|----------------------|-----|-----|---------------|--|
| 1                    | 2   | 3   |               |  |
| OFF                  | OFF | OFF | OFF           | Reference 1: d1-01 (main-speed frequency, see note 1)      |
| ON                   | OFF | OFF | OFF           | Reference 2: d1-02 (auxiliary-speed frequency, see note 2) |
| OFF                  | ON  | OFF | OFF           | Reference 3: d1-03   |
| ON                   | ON  | OFF | OFF           | Reference 4: d1-04   |
| OFF                  | OFF | ON  | OFF           | Reference 5: d1-05   |
| ON                   | OFF | ON  | OFF           | Reference 6: d1-06   |
| OFF                  | ON  | ON  | OFF           | Reference 7: d1-07   |
| ON                   | ON  | ON  | OFF           | Reference 8: d1-08   |
| ---                  | --- | --- | ON            | Jog reference: d1-09                                       |

**Note 1.** Reference 1 is selected when b1-01 is set to “0” (Operator) and the analog input (terminal 13 or 14) is selected when b1-01 is set to “1” (Terminals).

**Note 2.** The analog input from terminal 16 is selected when H3-05 is set to “0” (Auxiliary Reference) and reference 2 is selected for any other H3-05 setting.

Timing Chart

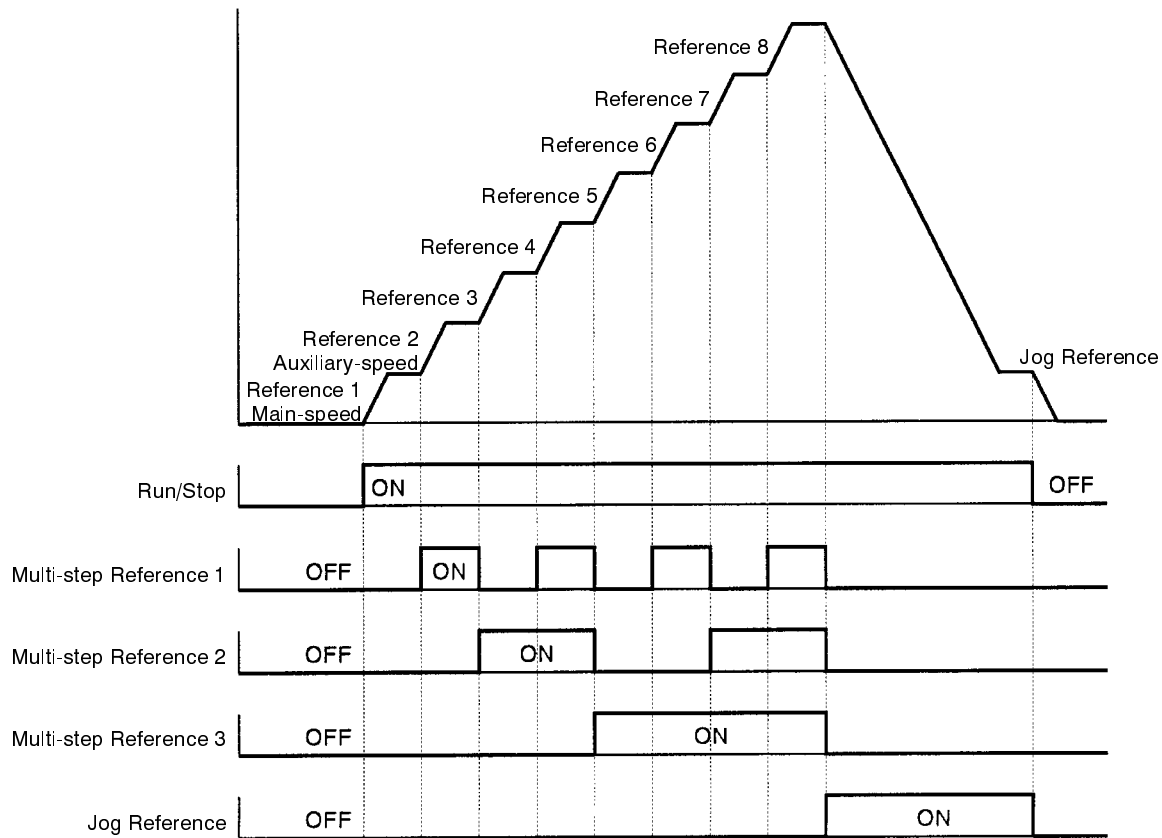

**Note** The jog reference setting has priority over the multi-step reference settings.

● **Setting “7” and “1A”: Multi-Accel/Decel Time Selector 1 and 2**

Four acceleration times and four deceleration times can be set in the 3G3FV. Set “Multi-Accel/Decel 1 and 2” in multi-function inputs and change the status of these inputs to switch between these acceleration and deceleration times.

| Setting | Function  |
|---------|---|
| 7       | Multi-Accel/Decel 1 (multi-accel/decel time selector 1) |
| 1A      | Multi-Accel/Decel 2 (multi-accel/decel time selector 2) |

The following table shows which acceleration and deceleration times are selected by each possible combination of acceleration/deceleration time selectors 1 and 2.

| Multi-accel/decel time selector |                | Acceleration time           | Deceleration time           |
|---------------------------------|----------------|-----------------------------|-----------------------------|
| 1                               | 2              |                             |                             |
| OFF or not set                  | OFF or not set | Acceleration time 1 (C1-01) | Deceleration time 1 (C1-02) |
| ON                              | OFF or not set | Acceleration time 2 (C1-03) | Deceleration time 2 (C1-04) |
| OFF or not set                  | ON             | Acceleration time 3 (C1-05) | Deceleration time 3 (C1-06) |
| ON                              | ON             | Acceleration time 4 (C1-07) | Deceleration time 4 (C1-08) |

**Note** The acceleration and deceleration times can be changed while the Inverter is operating.

### ● Setting “15”: Fast-Stop (Emergency Stop)

When the multi-function input that is set to “Fast-Stop” is turned ON, the motor will decelerate to a stop at the rate set with the deceleration time in C1-09 (fast-stop time). To clear the emergency stop, turn the run command OFF, turn the fast-stop input OFF, and then turn the run command ON again.

### ● Setting “12” and “13”: Forward and Reverse Jog Commands

The jog function can operate in forward or reverse. The forward jog and reverse jog commands have priority over other frequency reference commands.

| Setting | Function   |
|---------|--|
| 12      | Forward Jog command: Runs forward at the jog reference frequency (d1-09).    |
| 13      | Reverse Jog command: Runs in reverse at the jog reference frequency (d1-09). |

The inverter will stop operation with the stopping method is set in b1-03 if the forward jog and reverse jog commands are both on for more than 500 ms. Turn ON either the forward jog command or the reverse jog command, not both.

These jog commands can operate the Inverter independently. It isn't necessary for a forward/reverse command to be input.

### ● Setting “1F”: Terminal 13/14 Switch

When this function is set in a multi-function input, that input terminal can be used to switch between terminal 13 and terminal 14.

|     |  |
|-----|--|
| OFF | The analog input from terminal 13 is used as the main-speed frequency reference. |
| ON  | The analog input from terminal 14 is used as the main-speed frequency reference. |

When terminal 14 is used as the frequency reference, set “1F” (frequency reference) in parameter H3-09; this parameter is the function selector for frequency reference (current) terminal 14. A setting fault (OPE03) will occur if this function is selected without setting “1F” in H3-09.

When H3-09 is set to “1F” (frequency reference) but none of the multi-function inputs is set to “1F” (terminal 13/14 switch), the sum of the inputs from terminals 13 and 14 will be used as the main-speed frequency reference.

## 5-2 Open-loop Vector Control

Open-loop vector control is vector control without pulse generator input. Auto-tuning is the only setting for basic operation with open-loop vector control

To operate with the greatest speed precision near the rated speed, select a motor with a rated voltage that is at least 20 V below the Inverter's input power supply voltage. When the input voltage is the same as the rated voltage, the voltage limit may be applied and vector control won't be established.

### 5-2-1 Auto-tuning Procedure

#### ■ Inverter Input Voltage Setting (E1-01)

Set the Inverter's input voltage (E1-01) to match the power supply voltage; it cannot be changed during operation. This setting is used as the reference value for functions such as the protection functions.

| Parameter number | Display name  | Setting range              | Units | Default setting | Valid access levels             |             |                  |             |
|------------------|---------------|----------------------------|-------|-----------------|---------------------------------|-------------|------------------|-------------|
|                  |               |                            |       |                 | V/f Control                     | V/f with PG | Open Loop Vector | Flux Vector |
| E1-01            | Input Voltage | 155 to 255<br>(310 to 510) | VAC   | 200<br>(400)    | Quick-start, Basic, or Advanced |             |                  |             |

**Note** The voltage settings shown in parentheses are the values for the 400-V class.

#### ■ Precautions Before Auto-tuning

 **Caution** Do not connect a load to the motor when performing auto-tuning. Doing so may result in personal injury or equipment damage.

- The Inverter's auto-tuning function automatically determines the motor constants while a servo system's auto-tuning function determines the size of a load, so these auto-tuning functions are fundamentally different.
- If a load is connected when auto-tuning is performed, not only will incorrect motor constants be recorded, but the motor may operate erratically resulting in dangerous conditions such as loads falling from vertical axis motors. Never perform auto-tuning with a load connected to the motor.

#### ■ Required Parameter Settings

Enter auto-tuning mode and make the following parameter settings:

|                  |  |
|------------------|--|
| Rated Voltage:   | Set the rated voltage (VAC) shown on the motor's nameplate.                    |
| Rated Current:   | Set the rated current (A) shown on the motor's nameplate.                      |
| Rated Frequency: | Set the rated frequency (Hz) shown on the motor's nameplate.                   |
| Rated Speed:     | Set the rated speed (r/min) shown on the motor's nameplate.                    |
| Number of poles: | Set the number of poles.   |
| Motor Selection: | Select motor 1.<br>For two-motor switching control, select motor 1 or motor 2. |

The following message will appear when the parameters have been set:

Tuning Ready ?  
Press RUN key



At this point, it is still possible to change the parameter settings by pressing the Increment and Decrement Keys to display the desired parameter.

Press the Menu Key to cancel auto-tuning. (The operation mode display will appear.)

### ■ Performing Auto-tuning

Auto-tuning will start if the Run Key is pressed when the “Tuning Ready?” message is being displayed. The motor will operate during auto-tuning, so be sure that it is safe for the motor to operate before pressing the Run Key.

The following message will be displayed when the Run Key is pressed:

```
Tune Proceeding
  HZ   A
```

Auto-tuning takes up to 1.5 minutes. The message “Tune Successful” will be displayed when auto-tuning is completed. If auto-tuning has been completed successfully, press the Menu Key and proceed to the next operation. If a fault occurred during auto-tuning, refer to *5-2-2 Auto-tuning Faults* for details on correcting the cause of the fault and perform auto-tuning again.

## 5-2-2 Auto-tuning Faults

One of the fault messages in the following table will be displayed if a fault occurs during auto-tuning. In this case, determine the cause of the fault, correct it, and perform auto-tuning again.

The fault display can be cleared by pressing the Menu Key. The motor constants will revert to their default settings if a fault occurs. Set these parameters again when auto-tuning.

| Fault display   | Probable cause and remedy  |
|---|--|
| Data Invalid<br>(Motor setting data fault)              | There was a fault in the data set during auto-tuning. <ul style="list-style-type: none"> <li>• There was a fault in the relationship between the rated frequency, rated speed, and number of poles.               <ul style="list-style-type: none"> <li>→ Change the settings to conform to the following formula:<br/> <math display="block">\text{Rated speed} &lt; 120 \times \text{Motor frequency} / \text{Number of poles}</math> </li> </ul> </li> </ul>   |
| ALARM: Over Load<br>(Excessive load during auto-tuning) | The effective load factor exceeded 20% during auto-tuning. <ul style="list-style-type: none"> <li>• A load is connected to the motor axis. → Remove the load.</li> <li>• There was a setting fault during auto-tuning.               <ul style="list-style-type: none"> <li>→ Check the rated current setting. Change if necessary.</li> </ul> </li> <li>• There is a motor bearing problem.               <ul style="list-style-type: none"> <li>→ Turn the Inverter off and rotate the motor by hand.<br/>                   Replace the motor if it doesn't turn smoothly.</li> </ul> </li> </ul> |
| Motor speed<br>(Motor speed fault)                      | The torque reference value exceeded 100% during auto-tuning. <ul style="list-style-type: none"> <li>• There is a broken/disconnected motor power wire.               <ul style="list-style-type: none"> <li>→ Check and replace wiring components if necessary.</li> </ul> </li> <li>• A load is connected to the motor axis. → Remove the load.</li> </ul>  |
| Accelerate<br>(Motor acceleration fault)                | The motor doesn't accelerate within the prescribed time. <ul style="list-style-type: none"> <li>• The torque limit function is operating.               <ul style="list-style-type: none"> <li>→ Initialize the torque limit parameters (H7-01 to H7-04).</li> </ul> </li> <li>• The acceleration time is too short.               <ul style="list-style-type: none"> <li>→ Increase acceleration time 1 (C1-01).</li> </ul> </li> <li>• A load is connected to the motor axis. → Remove the load.</li> </ul>  |

| <b>Fault display</b>                                  | <b>Probable cause and remedy</b>  |
|---|---|
| Rated Slip<br>(Rated slip fault)                      | The rated slip setting can't be tuned within the prescribed time.<br>• A load is connected to the motor axis. → Remove the load.  |
| Saturation-1<br>(Core-saturation coefficient 1 fault) | The core-saturation coefficients can't be tuned within the prescribed time.<br>• The rated current setting isn't correct.<br>→ Check and change the setting if necessary.                         |
| Saturation-2<br>(Core-saturation coefficient 2 fault) | • There is a broken/disconnected motor power wire.<br>→ Check and replace wiring components if necessary.   |
| Resistance<br>(Motor wire resistance fault)           | The motor terminal resistance or no-load current setting can't be tuned within the prescribed time.<br>• The rated current setting isn't correct.<br>→ Check and change the setting if necessary. |
| No-load Current<br>(Motor no-load current fault)      | • There is a broken/disconnected motor power wire.<br>→ Check and replace wiring components if necessary.   |

## 5-3 V/f Control

With V/f control, the user must set the Inverter's input voltage, motor selection, rated current, and V/f pattern.

### 5-3-1 Setting the Motor Constants

#### ■ Inverter Input Voltage Setting (E1-01)

Set the Inverter's input voltage (E1-01) to match the power supply voltage; it cannot be changed during operation. This setting is used as the reference value for functions such as the protection functions.

| Parameter number | Display name  | Setting range              | Units | Default setting | Valid access levels             |             |                  |             |
|------------------|---------------|----------------------------|-------|-----------------|---------------------------------|-------------|------------------|-------------|
|                  |               |                            |       |                 | V/f Control                     | V/f with PG | Open Loop Vector | Flux Vector |
| E1-01            | Input Voltage | 155 to 255<br>(310 to 510) | VAC   | 200<br>(400)    | Quick-start, Basic, or Advanced |             |                  |             |

**Note** The voltage settings shown in parentheses are the values for the 400-V class.

#### ■ Motor Selection and Rated Current Setting (E1-02 and E2-01)

Set the type of motor being used with the motor selection parameter (E1-02). This setting is a reference for the protection functions. This parameter cannot be changed during operation.

| Parameter number | Display name    | Setting range | Units | Default setting | Valid access levels             |             |                  |             |
|------------------|-----------------|---------------|-------|-----------------|---------------------------------|-------------|------------------|-------------|
|                  |                 |               |       |                 | V/f Control                     | V/f with PG | Open Loop Vector | Flux Vector |
| E1-02            | Motor Selection | 0 or 1        | ---   | 0               | Quick-start, Basic, or Advanced |             |                  |             |

#### E1-02 Settings

| Setting | Function  |
|---------|---|
| 0       | Standard fan-cooled motor (general-purpose motor)       |
| 1       | Standard blower-cooled motor (inverter-exclusive motor) |

Set parameter (E2-01) to rated current (A) shown on the motor's nameplate. This parameter cannot be changed during operation.

| Parameter number | Display name    | Setting range <sup>1</sup> | Units | Default setting <sup>2</sup> | Valid access levels             |             |                  |             |
|------------------|-----------------|----------------------------|-------|------------------------------|---------------------------------|-------------|------------------|-------------|
|                  |                 |                            |       |                              | V/f Control                     | V/f with PG | Open Loop Vector | Flux Vector |
| E2-01            | Motor Rated FLA | 10 to 200%                 | A     | (Note 2)                     | Quick-start, Basic, or Advanced |             |                  |             |

**Note 1.** The setting range is 10 to 200% of the Inverter's rated output current.

**Note 2.** The default setting depends upon the type of Inverter.

### 5-3-2 V/f Pattern Selection (E1-03)

Set the V/f pattern with parameter E1-03. This parameter cannot be changed during operation.

| Parameter number | Display name  | Setting range | Units | Default setting | Valid access levels             |             |                  |             |
|------------------|---------------|---------------|-------|-----------------|---------------------------------|-------------|------------------|-------------|
|                  |               |               |       |                 | V/f Control                     | V/f with PG | Open Loop Vector | Flux Vector |
| E1-03            | V/f Selection | 0 to F        | ---   | F               | Quick-start, Basic, or Advanced |             | Not applicable.  |             |

The V/f pattern settings can be divided into two categories: the 15 preset patterns (settings 0 through E) and custom user-set patterns (setting F). The factory default setting for E1-03 is “F” (user-defined V/f pattern), but the contents of this setting are actually the same as setting “1.”

#### ■ Selecting a Preset V/f Pattern (Settings “0” through “E”)

Refer to the following table when selecting one of the 15 preset patterns.

| Characteristics      | Applications  | Setting | Specifications                      |
|----------------------|---|---------|-------------------------------------|
| General-purpose      | These patterns are for general-purpose applications.<br>Use these patterns when there is a roughly proportional relationship between the rotational speed and load, such as in straight-line conveyors. | 0       | 50 Hz                               |
|                      |   | 1       | 60 Hz                               |
|                      |   | 2       | 60 Hz, Voltage saturation at 50 Hz  |
|                      |   | 3       | 72 Hz, Voltage saturation at 60 Hz  |
| Variable torque      | Use these patterns when there is a quadratic or cubic relationship between the rotational speed and load, such as in fans or pumps.   | 4       | 50 Hz, cubic                        |
|                      |   | 5       | 50 Hz, quadratic                    |
|                      |   | 6       | 60 Hz, cubic                        |
|                      |   | 7       | 60 Hz, quadratic                    |
| High starting torque | (Normally it isn't necessary to use these patterns because starting torque is ensured by automatic torque boost functions.)   | 8       | 50 Hz, low starting torque          |
|                      |   | 9       | 50 Hz, high starting torque         |
|                      |   | A       | 60 Hz, low starting torque          |
|                      |   | b       | 60 Hz, high starting torque         |
| High-speed operation | These patterns are for applications that must rotate at frequencies greater than 60 Hz. A fixed voltage is applied at frequencies greater than 60 Hz.   | C       | 90 Hz, Voltage saturation at 60 Hz  |
|                      |   | d       | 120 Hz, Voltage saturation at 60 Hz |
|                      |   | E       | 180 Hz, Voltage saturation at 60 Hz |

**Note 1.** Select a high starting torque V/f pattern only in the following cases:

- The wiring distance between the Inverter and motor is relatively large (greater than 150 m).
- A large torque is required at startup (such as heavy axis loads).
- An AC or DC reactor is connected to the Inverter's input or output.

**Note 2.** The parameter settings for E1-04 through E1-10 will be changed automatically when one of these patterns is selected. There are three possible settings for these parameters depending on the Inverter's capacity: a 0.4 to 1.5 kW V/f pattern, a 2.2 to 45 kW V/f pattern, and a 55 kW V/f pattern.

**Note 3.** The characteristics for these patterns are shown in the diagrams on the following pages. The voltages in these graphs are for 200-V class Inverters. Double the voltage for 400-V class Inverters.

V/f Patterns: 0.4 to 1.5 kW

• General-purpose Characteristics (Settings 0 to 3)

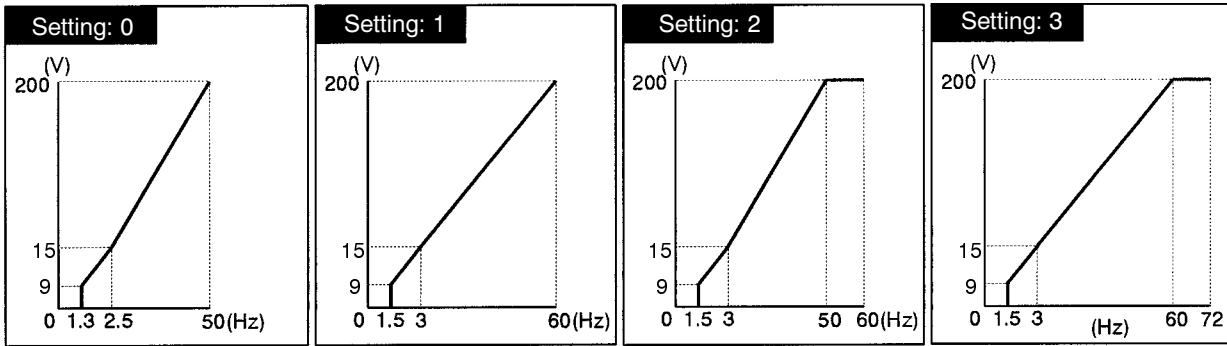

• Variable Torque Characteristics (Settings 4 to 7)

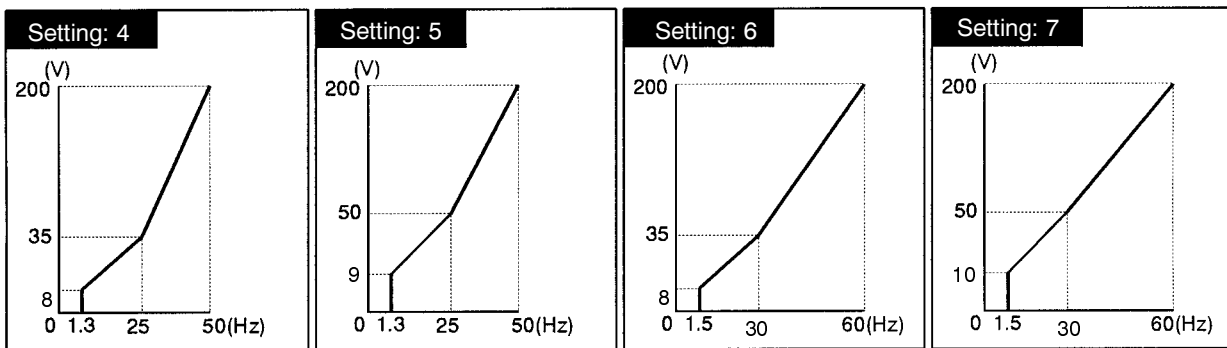

• High Starting Torque Characteristics (Settings 8 to b)

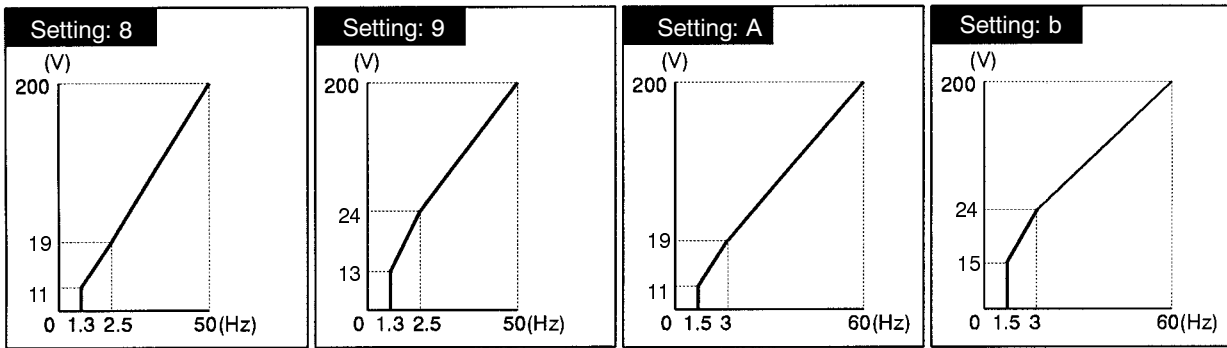

• High-speed Operation (Settings C to E)

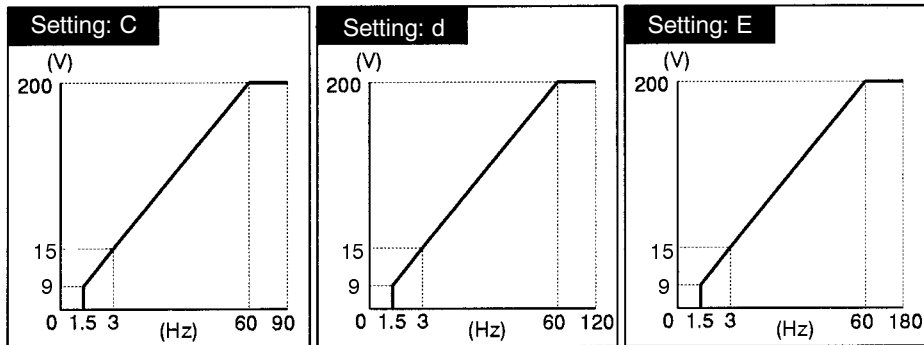

**Note** The voltages above are for 200-V class Inverters. Double the voltages for 400-V class Inverters.

V/f Patterns: 2.2 to 45 kW

• General-purpose Characteristics (Settings 0 to 3)

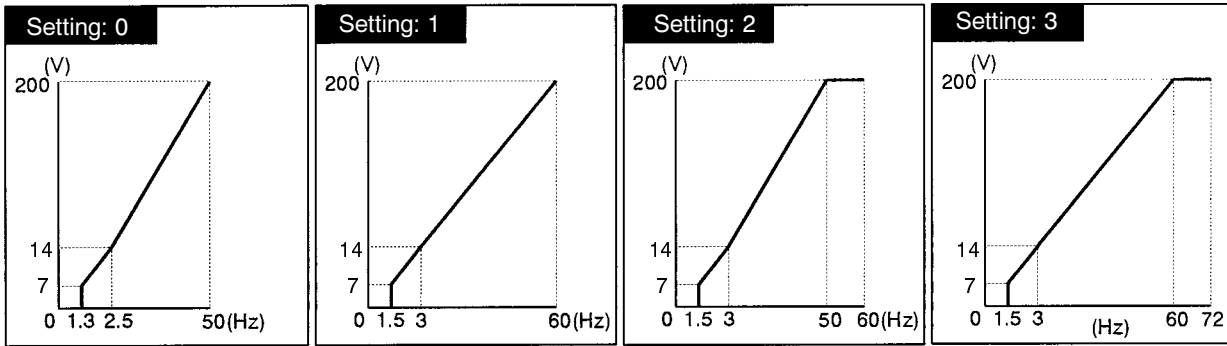

• Variable Torque Characteristics (Settings 4 to 7)

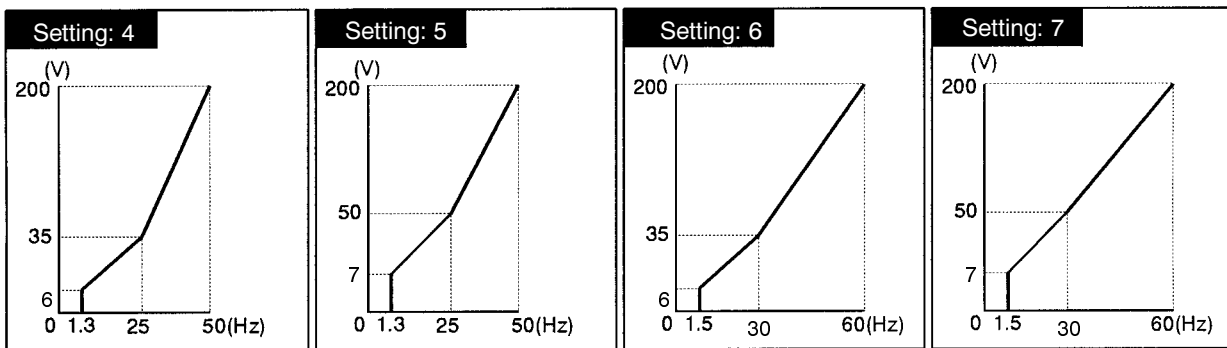

• High Starting Torque Characteristics (Settings 8 to b)

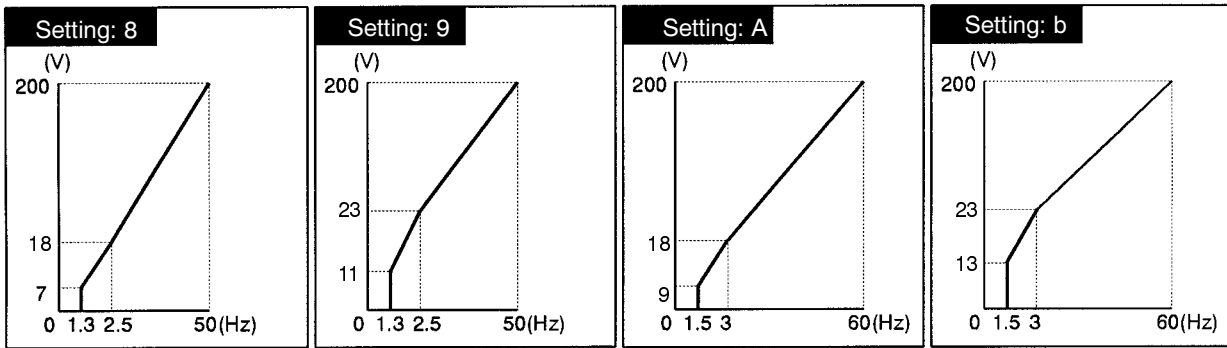

• High-speed Operation (Settings C to E)

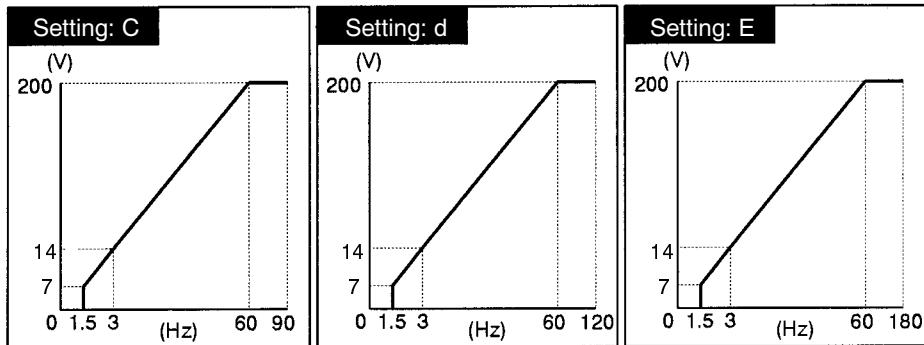

**Note** The voltages above are for 200-V class Inverters. Double the voltages for 400-V class Inverters.

V/f Patterns: 55 to 300 kW

• General-purpose Characteristics (Settings 0 to 3)

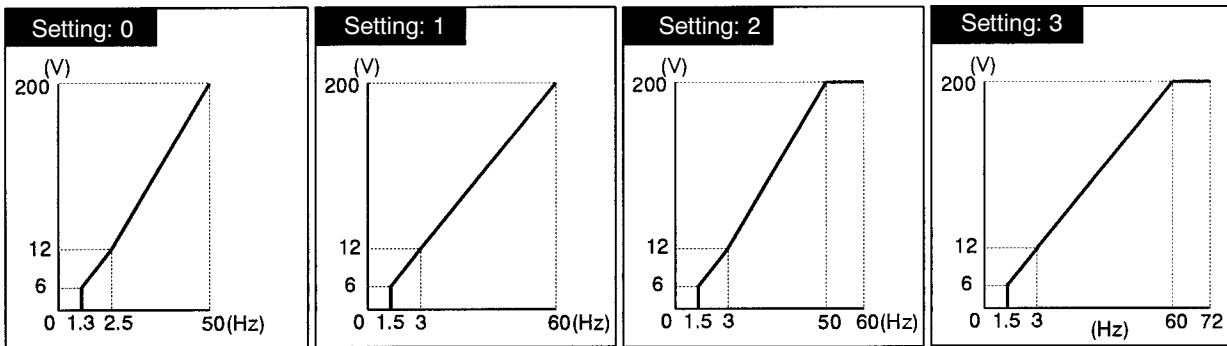

• Variable Torque Characteristics (Settings 4 to 7)

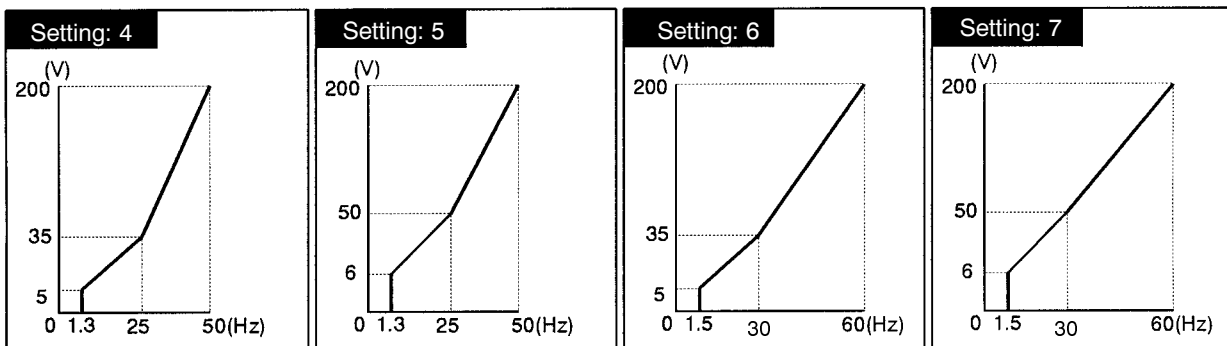

• High Starting Torque Characteristics (Settings 8 to b)

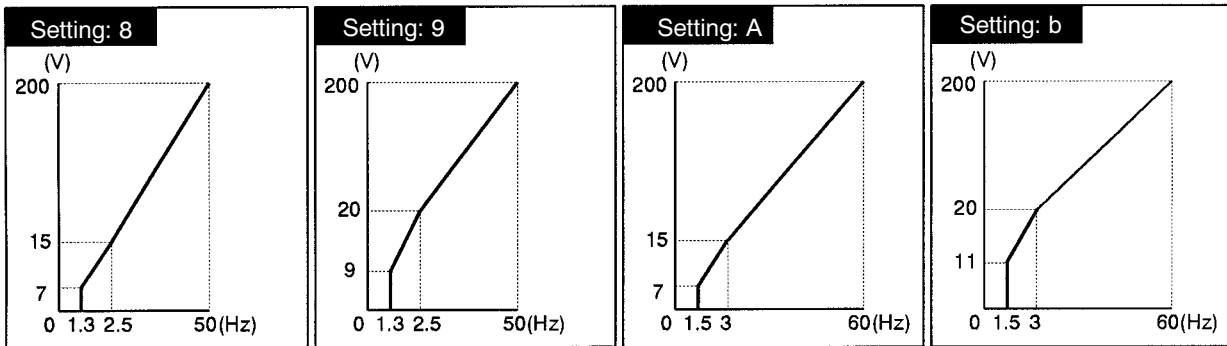

• High-speed Operation (Settings C to E)

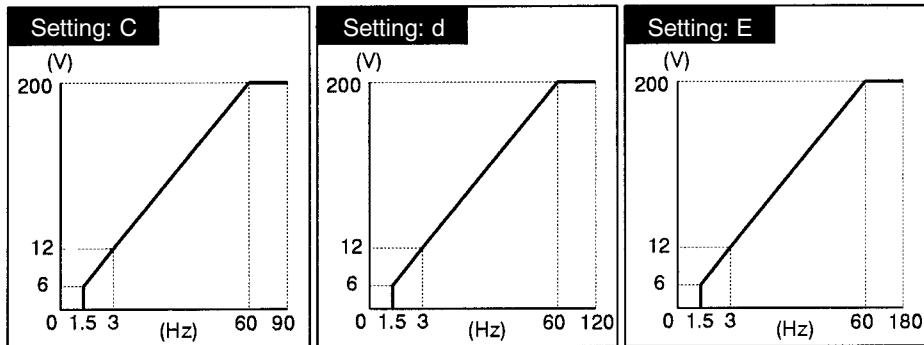

**Note** The voltages above are for 200-V class Inverters. Double the voltages for 400-V class Inverters.

■ **Setting a User-defined V/f Pattern (Setting “F”)**

Parameters E1-04 through E1-10 can be set by the user when E1-03 has been set to “F.” These parameters are read-only when E1-03 isn’t set to “F.” Parameters E1-04 through E1-10 cannot be changed during operation.

When making the V/f characteristics a straight line, set the same value in E1-07 (middle output frequency) and E1-09 (minimum output frequency). In this case, parameter E1-08 (middle output voltage) will be ignored.

| Parameter number | Display name    | Setting range  | Units | Default setting | Valid access levels*1 |             |                  |             |
|------------------|-----------------|----------------|-------|-----------------|-----------------------|-------------|------------------|-------------|
|                  |                 |                |       |                 | V/f Control           | V/f with PG | Open Loop Vector | Flux Vector |
| E1-04            | Max Frequency   | 50.0 to 400.0  | Hz    | 60.0            | Q                     | Q           | Q                | Q           |
| E1-05            | Max Voltage     | 0.0 to 255.0*2 | VAC   | 200.0*2         | Q                     | Q           | Q                | Q           |
| E1-06            | Base Frequency  | 0.0 to 400.0   | Hz    | 60.0            | Q                     | Q           | Q                | Q           |
| E1-07            | Mid Frequency A | 0.0 to 400.0   | Hz    | 3.0             | Q                     | Q           | A                | ---         |
| E1-08            | Mid Voltage A   | 0.0 to 255.0*2 | VAC   | 15.0*2,3        | Q                     | Q           | A                | ---         |
| E1-09            | Min Frequency   | 0.0 to 400.0   | Hz    | 1.5             | Q                     | Q           | Q                | A           |
| E1-10            | Min Voltage     | 0.0 to 255.0*2 | VAC   | 9.0*2,3         | Q                     | Q           | A                | ---         |

**Note 1.** Q: Quick-start, Basic, or Advanced  
 A: Advanced only  
 ---: Not applicable.

**Note 2.** These voltages are for the 200-V class; Double the voltage for 400-V class Inverters.

**Note 3.** The default setting depends on the Inverter’s capacity. The default settings shown in the table are for 200-V class, 0.4 to 1.5 kW Inverters. Refer to the graphs for “Setting: 1” on pages 5-25 and 5-26 for the default settings in 2.2 to 45 kW and 55 to 300 kW Inverters.

**Note 4.** The default settings for E1-07 through E1-10 depend on the control mode. The default settings shown in the table are for V/f control.

**Note 5.** The four frequency settings must satisfy the following formula:  
 $E1-04 (F_{MAX}) \geq E1-06 (F_A) > E1-07 (F_B) \geq E1-09 (F_{MIN})$

**User-defined V/f Pattern**

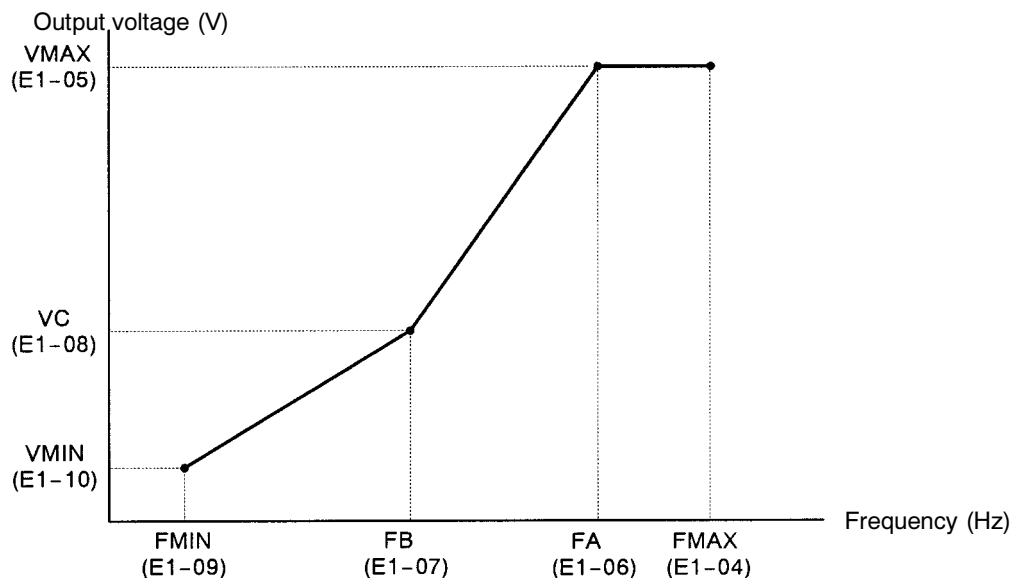



## 5-4 Flux Vector Control

With flux vector control (vector control with PG), make the settings for the PG Speed Control Card, select the zero-speed operation method, set the various auto-tuning parameters, and then adjust the gain of the speed control loop.

To ensure high-precision torque/speed control, use a motor specifically designed for vector control with an integrated PG. Always use an Inverter with twice the motor's capacity when a large load (50% or more of the rated current) is applied while in zero-speed, such as with a vertical-axis load.

When setting up a separate PG (encoder), connect it directly to the motor axis. If the PG is connected to the motor via gearing or belts, responses can be delayed by backlash or torsion; the delayed responses can generate vibration and make control impossible.

### 5-4-1 PG Speed Control Card Settings

#### ■ Available PG Speed Control Cards

There are 4 types of PG Speed Control Cards, but only 2 types can be used with vector control.

3G3FV-PPGB2: Phase-A/Phase-B pulse inputs, inputs for open collector

3G3FV-PPGX2: Phase-A/Phase-B/Phase-Z pulse inputs, line driver inputs

Select the Card according to the application and install it in the Inverter as described in *2-2-6 Installing and Wiring PG Speed Control Cards*.

#### ■ Setting the PG Pulse Number (F1-01)

Set the PG (pulse generator or encoder) pulse number in pulses/revolution. Set the number of phase A or phase B pulses in one motor revolution. This parameter cannot be changed during operation.

| Parameter number | Display name  | Setting range | Units | Default setting | Valid access levels* |             |                  |             |
|------------------|---------------|---------------|-------|-----------------|----------------------|-------------|------------------|-------------|
|                  |               |               |       |                 | V/f Control          | V/f with PG | Open Loop Vector | Flux Vector |
| F1-01            | PG Pulses/Rev | 0 to 60,000   | p/r   | 1,000           | ---                  | Q           | ---              | Q           |

**Note** Q: Quick-start, Basic, or Advanced

---: Not applicable.

#### ■ Setting the PG Rotation Direction (F1-05)

This parameter is used to coordinate the PG's rotation direction with the motor's rotation direction; it cannot be changed during operation.

Generally, phase A leads when the PG rotates in the clockwise direction (looking from the input axis). When a forward command is input to the inverter, the motor rotates in the counterclockwise direction (looking from the output axis).

(These directions may be reversed in PG-integrated motors or other motors.)

Set whether phase A or phase B leads when the motor operates in the forward direction.

| Parameter number | Display name    | Setting range | Units | Default setting | Valid access levels* |             |                  |             |
|------------------|-----------------|---------------|-------|-----------------|----------------------|-------------|------------------|-------------|
|                  |                 |               |       |                 | V/f Control          | V/f with PG | Open Loop Vector | Flux Vector |
| F1-05            | PG Rotation Sel | 0 or 1        | ---   | 0               | ---                  | B           | ---              | B           |

**Note B:** Basic or Advanced  
 ---: Not applicable.

**PG Rotation Settings**

| Setting | Function  |
|---------|---|
| 0       | Phase A leads with forward command. (Phase B leads with reverse command.) |
| 1       | Phase B leads with forward command. (Phase A leads with reverse command.) |

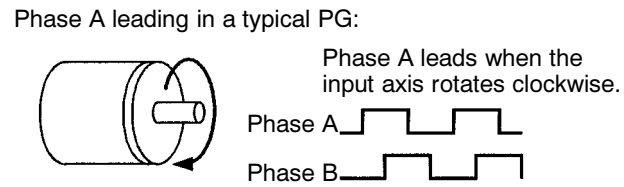
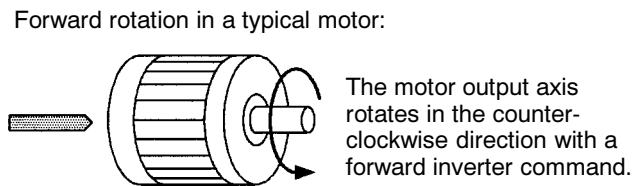
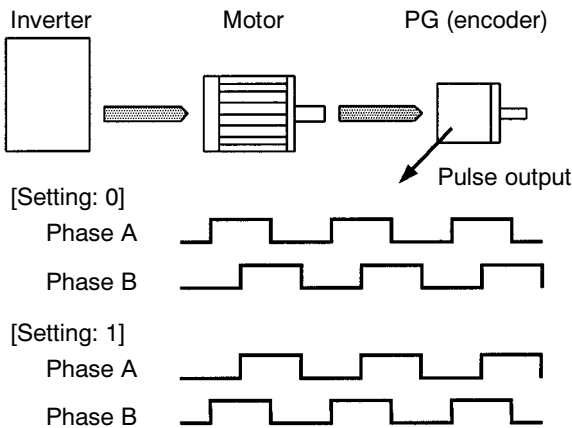

■ **Setting the PG Pulse Output Monitor Division Ratio (F1-06)**

This parameter is effective only when a 3G3FV-PPB2 is used; it sets the division ratio used when the pulse monitor output is connected to a pulse input device. This parameter cannot be changed during operation.

| Parameter number | Display name    | Setting range          | Units | Default setting | Valid access levels* |             |                  |             |
|------------------|-----------------|------------------------|-------|-----------------|----------------------|-------------|------------------|-------------|
|                  |                 |                        |       |                 | V/f Control          | V/f with PG | Open Loop Vector | Flux Vector |
| F1-06            | PG Output Ratio | 001 to 032, 101 to 132 | ---   | 1               | ---                  | B           | ---              | B           |

**Note B:** Basic or Advanced  
 ---: Not applicable.

The first digit in the setting (0 or 1) is n and the second two digits (01 to 32) are m. The division ratio is calculated from n and m with the following equation:

F1 - 06 =  $\begin{matrix} \square & \square & \square \\ | & | & | \\ m & & n \end{matrix}$

$$\text{Division ratio} = \frac{(1 + n)}{m}$$

The possible division ratio settings:  $1/32 \leq F1-06 \leq 1$

■ Setting and Adjusting the Fault Detection Functions

● PG Disconnection Stopping Method (F1-02)

This parameter sets the stopping method that is used when the signal from the PG is lost.

| Parameter number | Display name     | Setting range | Units | Default setting | Valid access levels* |             |                  |             |
|------------------|------------------|---------------|-------|-----------------|----------------------|-------------|------------------|-------------|
|                  |                  |               |       |                 | V/f Control          | V/f with PG | Open Loop Vector | Flux Vector |
| F1-02            | PG Fdbk Loss Sel | 0 to 3        | ---   | 1               | ---                  | B           | ---              | B           |

**Note B:** Basic or Advanced  
 ---: Not applicable.

Settings

| Setting | Name          | Function  |
|---------|---------------|---|
| 0       | Ramp to Stop  | Deceleration stop using deceleration time 1 (C1-02).                      |
| 1       | Coast to Stop | Free-run stop   |
| 2       | Fast Stop     | Emergency stop using the fast-stop time (C1-09).                          |
| 3       | Alarm Only    | Continue operation (This setting can't be made with flux vector control.) |

● Overspeed Settings (F1-03, F1-08, and F1-09)

Overspeed refers to an excessive motor speed. These parameters set the conditions for an overspeed fault and the stopping method that is used when an overspeed fault occurs; they cannot be changed during operation.

Parameter F1-03 sets the stopping method that is used when an overspeed fault occurs.

| Parameter number | Display name     | Setting range | Units | Default setting | Valid access levels* |             |                  |             |
|------------------|------------------|---------------|-------|-----------------|----------------------|-------------|------------------|-------------|
|                  |                  |               |       |                 | V/f Control          | V/f with PG | Open Loop Vector | Flux Vector |
| F1-03            | PG Overspeed Sel | 0 to 3        | ---   | 1               | ---                  | B           | ---              | B           |

**Note B:** Basic or Advanced  
 ---: Not applicable.

Settings

| Setting | Name          | Function  |
|---------|---------------|---|
| 0       | Ramp to Stop  | Deceleration stop using deceleration time 1 (C1-02).                      |
| 1       | Coast to Stop | Free-run stop   |
| 2       | Fast Stop     | Emergency stop using the fast-stop time (C1-09).                          |
| 3       | Alarm Only    | Continue operation (This setting can't be made with flux vector control.) |

Parameter F1-08 sets the overspeed detection level as a percentage of the maximum output frequency. Parameter F1-09 sets the length of time that the motor speed must exceed the overspeed detection level in order to generate an overspeed fault.

| Parameter number | Display name     | Setting range | Units | Default setting | Valid access levels* |             |                  |             |
|------------------|------------------|---------------|-------|-----------------|----------------------|-------------|------------------|-------------|
|                  |                  |               |       |                 | V/f Control          | V/f with PG | Open Loop Vector | Flux Vector |
| F1-08            | PG Overspd Level | 0 to 120      | %     | 115             | ---                  | A           | ---              | A           |
| F1-09            | PG Overspd Time  | 0.0 to 2.0    | s     | 0.0             | ---                  | A           | ---              | A           |

**Note A:** Advanced  
 ---: Not applicable.

● **PG Speed Deviation Settings (F1-04, F1-10, and F1-11)**

PG speed deviation refers to the difference between the actual motor speed and the reference command speed. These parameters set the conditions for a PG speed deviation fault and the stopping method that is used when a PG speed deviation fault occurs; they cannot be changed during operation.

Parameter F1-04 sets the stopping method that is used when a PG speed deviation fault occurs.

| Parameter number | Display name     | Setting range | Units | Default setting | Valid access levels* |             |                  |             |
|------------------|------------------|---------------|-------|-----------------|----------------------|-------------|------------------|-------------|
|                  |                  |               |       |                 | V/f Control          | V/f with PG | Open Loop Vector | Flux Vector |
| F1-04            | PG Deviation Sel | 0 to 3        | ---   | 3               | ---                  | B           | ---              | B           |

**Note B:** Basic or Advanced

---: Not applicable.

**Settings**

| Setting | Name          | Function   |
|---------|---------------|--|
| 0       | Ramp to Stop  | Deceleration stop using deceleration time 1 (C1-02).       |
| 1       | Coast to Stop | Free-run stop  |
| 2       | Fast Stop     | Emergency stop using the fast-stop time (C1-09).           |
| 3       | Alarm Only    | Continue operation (Displays “DEV” and continues control.) |

Parameter F1-10 sets the PG speed deviation detection level as a percentage of the maximum output frequency. Parameter F1-11 sets the length of time that the difference between the motor speed and reference speed must exceed the PG speed deviation detection level in order to generate a PG speed deviation fault (DEV).

| Parameter number | Display name     | Setting range | Units | Default setting | Valid access levels* |             |                  |             |
|------------------|------------------|---------------|-------|-----------------|----------------------|-------------|------------------|-------------|
|                  |                  |               |       |                 | V/f Control          | V/f with PG | Open Loop Vector | Flux Vector |
| F1-10            | PG Deviate Level | 0 to 50       | %     | 10              | ---                  | A           | ---              | A           |
| F1-11            | PG Deviate Time  | 0.0 to 10.0   | s     | 0.5             | ---                  | A           | ---              | A           |

**Note A:** Advanced

---: Not applicable.

**5-4-2 Setting the Zero-speed Operation Parameters**

With flux vector control, operation is possible even when the frequency reference is zero (below the minimum output frequency). Parameter E1-09 sets the minimum output frequency and B1-05 sets the operation method around this minimum frequency. These parameters cannot be changed during operation.

■ **Selecting the Stopping Method (b1-03)**

Parameter b1-03 sets the stopping method used when a stop command is input.

| Parameter number | Display name    | Setting range | Units | Default setting | Valid access levels             |             |                  |             |
|------------------|-----------------|---------------|-------|-----------------|---------------------------------|-------------|------------------|-------------|
|                  |                 |               |       |                 | V/f Control                     | V/f with PG | Open Loop Vector | Flux Vector |
| b1-03            | Stopping Method | 0 to 3        | ---   | 0               | Quick-start, Basic, or Advanced |             |                  |             |

Settings

| Setting | Name                 | Function  |
|---------|----------------------|---|
| 0       | Ramp to Stop         | Deceleration stop   |
| 1       | Coast to Stop        | Free-run stop   |
| 2       | DC Injection to Stop | DC braking stop (This setting can't be made with flux vector control.)          |
| 3       | Coast w/Timer        | Free-run stop with timer (This setting can't be made with flux vector control.) |

■ Setting the Zero-speed Operation Method (b1-05)

Parameter b1-05 sets the operation method used when the frequency reference is below the minimum output frequency set in E1-09.

| Parameter number | Display name    | Setting range | Units | Default setting | Valid access levels |             |                  |             |
|------------------|-----------------|---------------|-------|-----------------|---------------------|-------------|------------------|-------------|
|                  |                 |               |       |                 | V/f Control         | V/f with PG | Open Loop Vector | Flux Vector |
| b1-05            | Zero Speed Oper | 0 to 3        | ---   | 0               | Not applicable.     |             |                  | Advanced    |

Settings

| Setting | Name                 | Function  |
|---------|----------------------|---|
| 0       | RUN at Frequency Ref | Operate according to the frequency reference. (E1-09 is invalid.)                           |
| 1       | STOP                 | Interrupt the output. (Coast when the frequency reference is below E1-09.)                  |
| 2       | RUN at Min Frequency | Operate at E1-09 frequency. (Output the frequency set in E1-09.)                            |
| 3       | RUN at Zero RPM      | Zero-speed operation<br>(Zero reference value when the frequency reference is below E1-09.) |

Parameter E1-09 sets the minimum output frequency. Set this minimum level to satisfy the requirements of the application.

| Parameter number | Display name  | Setting range | Units | Default setting | Valid access levels             |             |                  |             |
|------------------|---------------|---------------|-------|-----------------|---------------------------------|-------------|------------------|-------------|
|                  |               |               |       |                 | V/f Control                     | V/f with PG | Open Loop Vector | Flux Vector |
| E1-09            | Min Frequency | 0.0 to 400.0  | ---   | 0.0             | Quick-start, Basic, or Advanced |             |                  | Advanced    |

■ Initial Excitation Function Settings (b2-01, b2-03, and b2-04)

With flux vector control, the DC braking (injection) function is replaced by the initial excitation function. The initial excitation function stops a motor that is rotating because of inertia. These parameters cannot be changed during operation.

| Parameter number | Name (not displayed)                  | Setting range | Units | Default setting | Valid access levels |             |                  |             |
|------------------|---------------------------------------|---------------|-------|-----------------|---------------------|-------------|------------------|-------------|
|                  |                                       |               |       |                 | V/f Control         | V/f with PG | Open Loop Vector | Flux Vector |
| b2-01            | Excitation level                      | 0.0 to 10.0   | Hz    | 0.0             | Basic or Advanced   |             |                  |             |
| b2-03            | Initial excitation time when starting | 0.00 to 10.00 | s     | 0.00            | Basic or Advanced   |             |                  |             |
| b2-04            | Initial excitation time when stopping | 0.00 to 10.00 | s     | 0.50            | Basic or Advanced   |             |                  |             |

The timing of the initial excitation function depends on the zero-speed operation method selected with b1-05, as shown in the following diagrams.

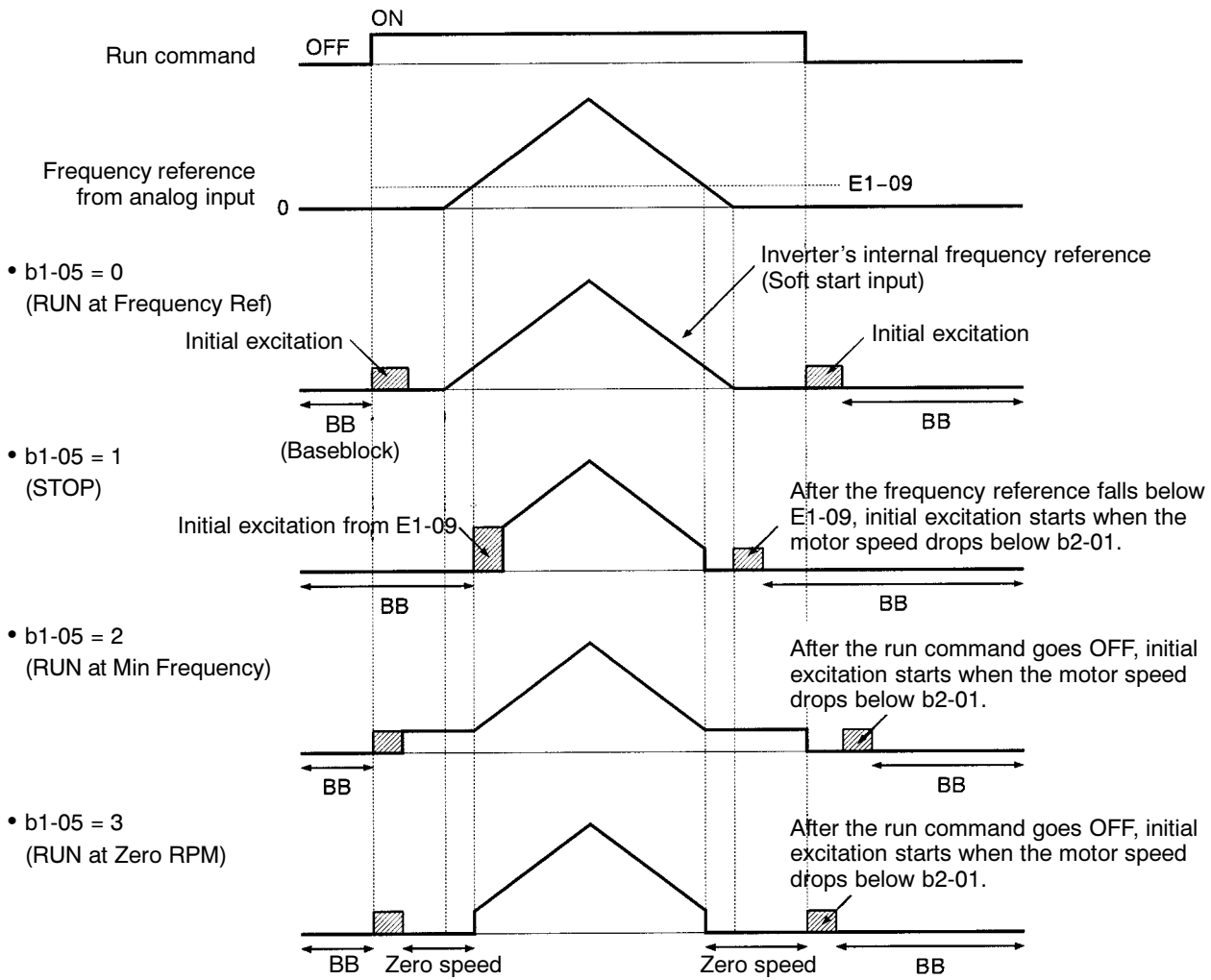

**Note 1.** Initial excitation is started from b2-01 (excitation level) when decelerating. A setting of b2-01 < E1-09 is valid only with flux vector control.

**Note 2.** The current level for the initial excitation function is set in E2-03 (no-load current). The DC braking (injection) current (b2-02) isn't used with flux vector control and can't be set.

### 5-4-3 Auto-tuning

#### ■ Inverter Input Voltage Setting (E1-01)

Set the Inverter's input voltage (E1-01) to match the power supply voltage; it cannot be changed during operation. This setting is used as the reference value for functions such as the protection functions.

| Parameter number | Display name  | Setting range              | Units | Default setting | Valid access levels             |             |                  |             |
|------------------|---------------|----------------------------|-------|-----------------|---------------------------------|-------------|------------------|-------------|
|                  |               |                            |       |                 | V/f Control                     | V/f with PG | Open Loop Vector | Flux Vector |
| E1-01            | Input Voltage | 155 to 255<br>(310 to 510) | VAC   | 200<br>(400)    | Quick-start, Basic, or Advanced |             |                  |             |

**Note** The voltage settings shown in parentheses are the values for the 400-V class.

## ■ Precautions Before Auto-tuning

 **Caution** Do not connect a load to the motor when performing auto-tuning. Doing so may result in personal injury or equipment damage.

- The Inverter's auto-tuning function automatically determines the motor constants while a servo system's auto-tuning function determines the size of a load, so these auto-tuning functions are fundamentally different.
- If a load is connected when auto-tuning is performed, not only will incorrect motor constants be recorded, but the motor may operate erratically resulting in dangerous conditions such as loads falling from vertical axis motors. Never perform auto-tuning with a load connected to the motor.

## ■ Required Parameter Settings

Enter auto-tuning mode and make the following parameter settings:

|                  |  |
|------------------|--|
| Rated Voltage:   | Set the rated voltage (VAC) shown on the motor's nameplate.                    |
| Rated Current:   | Set the rated current (A) shown on the motor's nameplate.                      |
| Rated Frequency: | Set the rated frequency (Hz) shown on the motor's nameplate.                   |
| Rated Speed:     | Set the rated speed (r/min) shown on the motor's nameplate.                    |
| Number of poles: | Set the number of poles.   |
| Motor Selection: | Select motor 1.<br>For two-motor switching control, select motor 1 or motor 2. |
| PG Pulses/Rev:   | Set the number of A-phase or B-phase pulses per revolution.                    |

The following message will appear when the parameters have been set:

Tuning Ready ?  
Press RUN key

At this point, it is still possible to change the parameter settings by pressing the Increment and Decrement Keys to display the desired parameter.

Press the Menu Key to cancel auto-tuning. (The operation mode display will appear.)

## ■ Performing Auto-tuning

Auto-tuning will start if the Run Key is pressed when the "Tuning Ready?" message is being displayed. The motor will operate during auto-tuning, so be sure that it is safe for the motor to operate before pressing the Run Key.

The following message will be displayed when the Run Key is pressed:

Tune Proceeding  
HZ A

Auto-tuning takes up to 1.5 minutes. The message "Tune Successful" will be displayed when auto-tuning is completed. If auto-tuning has been completed successfully, press the Menu Key and proceed to the next operation.

## ■ Auto-tuning Faults

One of the fault messages in the following table will be displayed if a fault occurs during auto-tuning. In this case, determine the cause of the fault, correct it, and perform auto-tuning again.

The fault display can be cleared by pressing the Menu Key. The motor constants will revert to their default settings if a fault occurs. Set these parameters again when auto-tuning.

| <b>Fault display</b>                                    | <b>Probable cause and remedy</b>  |
|---|---|
| Data Invalid<br>(Motor setting data fault)              | There was a fault in the data set during auto-tuning. <ul style="list-style-type: none"> <li>• There was a fault in the relationship between the rated frequency, rated speed, and number of poles.<br/>→ Change the settings to conform to the following formula:<br/>Rated speed &lt; 120 × Motor frequency/Number of poles</li> </ul>  |
| ALARM: Over Load<br>(Excessive load during auto-tuning) | The effective load factor exceeded 20% during auto-tuning. <ul style="list-style-type: none"> <li>• A load is connected to the motor axis. → Remove the load.</li> <li>• There was a setting fault during auto-tuning.<br/>→ Check the rated current setting. Change if necessary.</li> <li>• The PG pulse number setting is incorrect.<br/>→ Check the setting and change if necessary.</li> <li>• There is a motor bearing problem.<br/>→ Turn the Inverter off and rotate the motor by hand.<br/>Replace the motor if it doesn't turn smoothly.</li> </ul> |
| Motor speed<br>(Motor speed fault)                      | The torque reference value exceeded 100% during auto-tuning. <ul style="list-style-type: none"> <li>• There is a broken/disconnected motor power wire.<br/>→ Check and replace wiring components if necessary.</li> <li>• The PG pulse number setting is incorrect.<br/>→ Check the setting and change if necessary.</li> <li>• The acceleration time is too short.<br/>→ Increase acceleration time 1 (C1-01).</li> <li>• A load is connected to the motor axis. → Remove the load.</li> </ul>   |
| Accelerate<br>(Motor acceleration fault)                | The motor doesn't accelerate within the prescribed time. <ul style="list-style-type: none"> <li>• The torque limit function is operating.<br/>→ Initialize the torque limit parameters (H7-01 to H7-04).</li> <li>• The acceleration time is too short.<br/>→ Increase acceleration time 1 (C1-01).</li> <li>• A load is connected to the motor axis. → Remove the load.</li> </ul>   |
| Rated Slip<br>(Rated slip fault)                        | The rated slip setting can't be tuned within the prescribed time. <ul style="list-style-type: none"> <li>• A load is connected to the motor axis. → Remove the load.</li> </ul>   |
| Saturation-1<br>(Core-saturation coefficient 1 fault)   | The core-saturation coefficients can't be tuned within the prescribed time. <ul style="list-style-type: none"> <li>• The rated current setting isn't correct.<br/>→ Check and change the setting if necessary.</li> </ul>   |
| Saturation-2<br>(Core-saturation coefficient 2 fault)   | <ul style="list-style-type: none"> <li>• There is a broken/disconnected motor power wire.<br/>→ Check and replace wiring components if necessary.</li> </ul>  |
| Resistance<br>(Motor wire resistance fault)             | The motor terminal resistance or no-load current setting can't be tuned within the prescribed time. <ul style="list-style-type: none"> <li>• The rated current setting isn't correct.<br/>→ Check and change the setting if necessary.</li> </ul>   |
| No-load Current<br>(Motor no-load current fault)        | <ul style="list-style-type: none"> <li>• There is a broken/disconnected motor power wire.<br/>→ Check and replace wiring components if necessary.</li> </ul>  |



| Fault display                               | Probable cause and remedy   |
|---|---|
| PGO, PG Open<br>(Broken PG cable detection) | <p>Pulses aren't being input from the PG even though a rotation output is being sent to the motor.</p> <ul style="list-style-type: none"> <li>The cable to the PG is broken/disconnected.<br/>→ Check the wiring and correct any problems.</li> <li>The PG's power supply is broken/disconnected.<br/>→ Check the power supply voltage and correct if necessary.</li> </ul> |

### 5-4-4 Speed Loop (ASR) Structure

The following block diagram shows the structure of the speed loop.

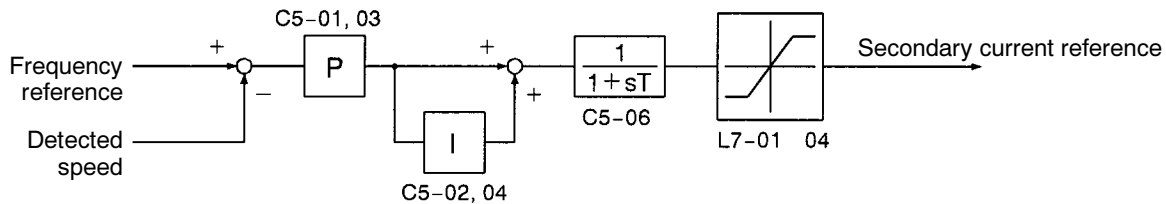

**Note** In vector flux control, the ASR's P gain is the maximum frequency standard.

#### ■ Regular Gain Settings (C5-01 and C5-02)

Parameter C5-01 sets the proportional gain of the speed loop (ASR), and C5-02 sets the integral time. Both of these parameters can be changed during operation.

| Parameter number | Display name | Setting range   | Units  | Default setting | Valid access levels* |             |                  |             |
|------------------|--------------|-----------------|--------|-----------------|----------------------|-------------|------------------|-------------|
|                  |              |                 |        |                 | V/f Control          | V/f with PG | Open Loop Vector | Flux Vector |
| C5-01            | ASR P Gain 1 | 0.00 to 300.00  | Factor | 20.00           | ---                  | B           | ---              | B           |
| C5-02            | ASR I Time 1 | 0.000 to 10.000 | s      | 0.500           | ---                  | B           | ---              | B           |

**Note** B: Basic or Advanced  
---: Not applicable.

#### ■ Low-speed Gain Settings (C5-03, C5-04, and C5-07)

Use these parameters to use different proportional gain and integral time settings for low-speed operation. Parameter C5-03 sets the proportional gain of the speed loop (ASR), and C5-04 sets the integral time. Both of these parameters can be changed during operation.

| Parameter number | Display name | Setting range   | Units  | Default setting | Valid access levels* |             |                  |             |
|------------------|--------------|-----------------|--------|-----------------|----------------------|-------------|------------------|-------------|
|                  |              |                 |        |                 | V/f Control          | V/f with PG | Open Loop Vector | Flux Vector |
| C5-03            | ASR P Gain 2 | 0.00 to 300.00  | Factor | 20.00           | ---                  | B           | ---              | B           |
| C5-04            | ASR I Time 2 | 0.000 to 10.000 | s      | 0.500           | ---                  | B           | ---              | B           |

**Note** B: Basic or Advanced  
---: Not applicable.

Parameter C5-07 is the “ASR Gain Switching Frequency Level.” ASR P Gain 1 and ASR I Time 1 are used when the frequency is above this level. Below this level, the proportional gain and integral time approach ASR P Gain 2 and ASR I Time 2 as the frequency approaches zero. This parameter cannot be changed during operation.

| Parameter number | Display name     | Setting range | Units | Default setting | Valid access levels* |             |                  |             |
|------------------|------------------|---------------|-------|-----------------|----------------------|-------------|------------------|-------------|
|                  |                  |               |       |                 | V/f Control          | V/f with PG | Open Loop Vector | Flux Vector |
| C5-07            | ASR Gain SW Freq | 0.0 to 400.0  | Hz    | 0.0             | Not applicable.      |             |                  |             |

**Note A:** Advanced

The following graph shows how the proportional gain and integral time approach ASR P Gain 2 and ASR I Time 2 linearly as the frequency approaches zero.

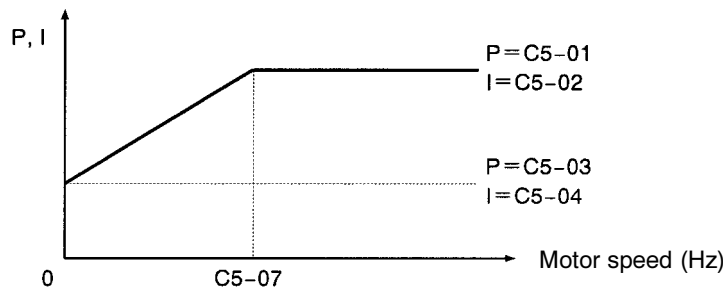

**Note** If C5-07 is set to 0.0, ASR P Gain 1 and ASR I Time 1 are used for the proportional gain and integral time at all frequencies.

■ Multi-function Input Settings (H1-01 through H1-06)

● ASR Integral Reset (Setting E)

When one of the multi-function inputs is set to “E,” the input can be used to switch the speed control loop between P control and PI control. P control (integral reset) is used when the multi-function input is ON.

● ASR Proportional Gain Switch (Setting 77)

When one of the multi-function inputs is set to “77,” the input can be used to switch between proportional gain 1 and proportional gain 2. Proportional gain 2 (C5-03) is used when the multi-function input is ON. This input has higher priority than the ASR switching frequency set in C5-07.

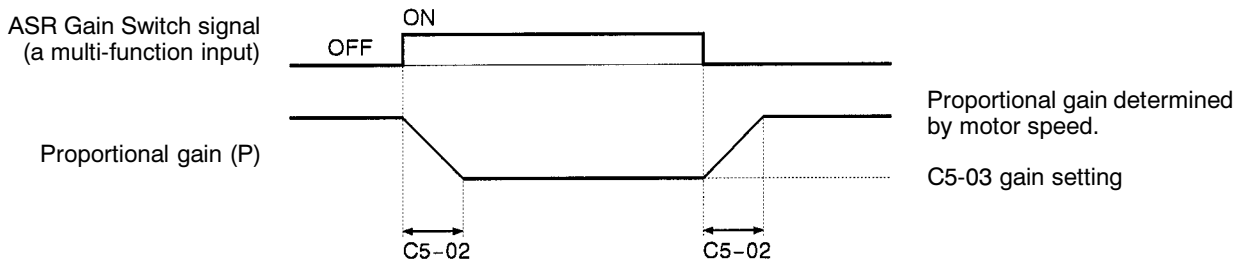

**Note** The gain is changed linearly in integral time 1 (C5-02). The integral time setting isn’t switched.

■ **Adjusting Speed Loop (ASR) Responsiveness (C5-06)**

Normally it isn't necessary to make this adjustment, but parameter C5-06 can be used when adjusting the gain doesn't remove motor vibration, or adjusting the gain removes vibration but results in poor responsiveness. A high C5-06 setting lowers the responsiveness of the speed control loop, but makes it difficult for vibration to develop. This parameter cannot be changed during operation.

| Parameter number | Display name   | Setting range  | Units | Default setting | Valid access levels* |             |                  |             |
|------------------|----------------|----------------|-------|-----------------|----------------------|-------------|------------------|-------------|
|                  |                |                |       |                 | V/f Control          | V/f with PG | Open Loop Vector | Flux Vector |
| C5-06            | ASR Delay Time | 0.000 to 0.500 | s     | 0.004           | Not applicable.      |             |                  |             |

Note A: Advanced

**5-4-5 Adjusting Speed Control Loop (ASR) Gain**

■ **Gain Adjustment Procedure**

Use the following procedure to adjust the gain with the mechanical system and actual load connected.

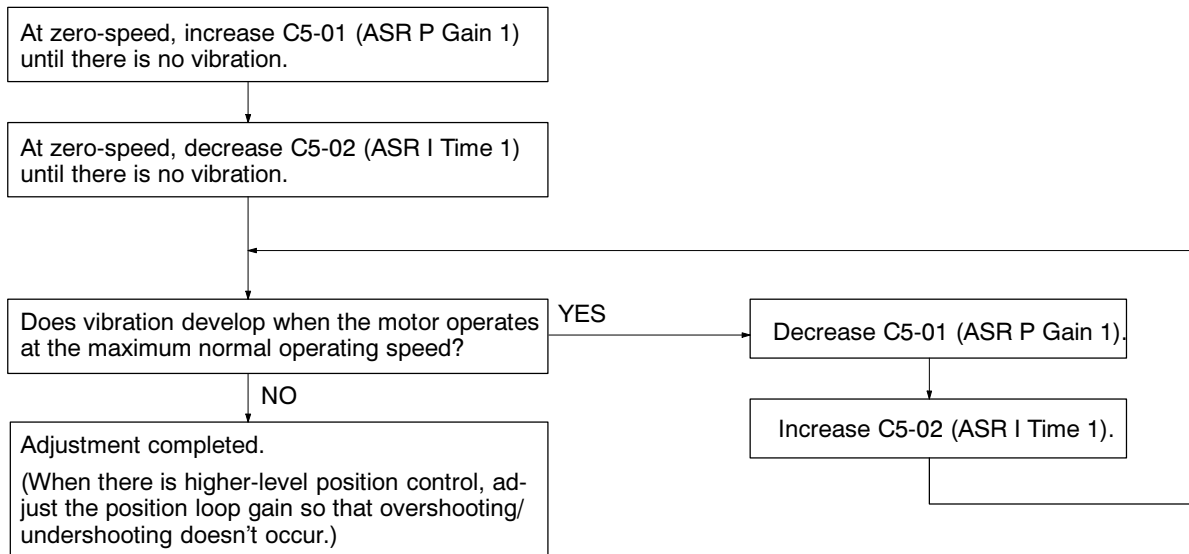

■ **Fine Adjustments**

When you want even finer gain adjustment, adjust the gain while observing the speed waveform. Parameter settings like those shown in the following table will be necessary to observe the speed waveform.

| Parameter                                   | Setting | Explanation   |
|---|---------|---|
| H4-01 Analog output selection (terminal 21) | 21      | Settings that allow multi-function analog output 1 to be used to monitor the ASR input.   |
| H4-02 Analog output gain (terminal 21)      | 1.00    |   |
| H4-03 Analog output bias (terminal 21)      | 0.0     |   |
| H4-04 Analog output selection (terminal 23) | 5       | Settings that allow multi-function analog output 2 to be used to monitor the motor speed. |
| H4-05 Analog output gain (terminal 23)      | 1.00    |   |
| H4-06 Analog output bias (terminal 23)      | 0.0     |   |
| H4-07 Analog output level selection         | 1       | This setting allows a 0 to ±10 V signal range to be monitored.                            |

The multi-function analog outputs have the following functions with these parameter settings. Terminal 22 is the multi-function analog output common.

Multi-function analog output 1 (terminal 21): Outputs the Inverter's ASR input (0 to  $\pm 10$  V).

Multi-function analog output 2 (terminal 23): Outputs the actual motor speed (0 to  $\pm 10$  V).

We recommend monitoring both the ASR input and the motor speed in order to observe a response delay or deviation from the reference value, as shown in the following diagram.

**Example Waveforms**

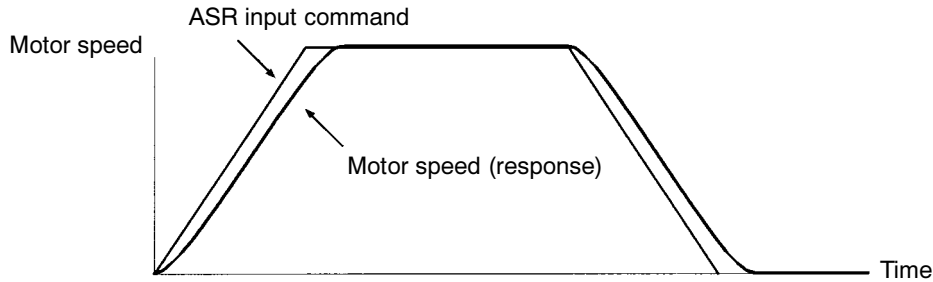

**• Adjusting ASR Proportional Gain 1 (C5-01)**

This gain setting adjusts the responsiveness of the speed control loop. The responsiveness is increased when this setting is increased. Usually this setting is higher for larger loads. Vibration will occur if this setting is increased too much.

The following diagram shows changes that occur in the response when the ASR proportional gain is changed.

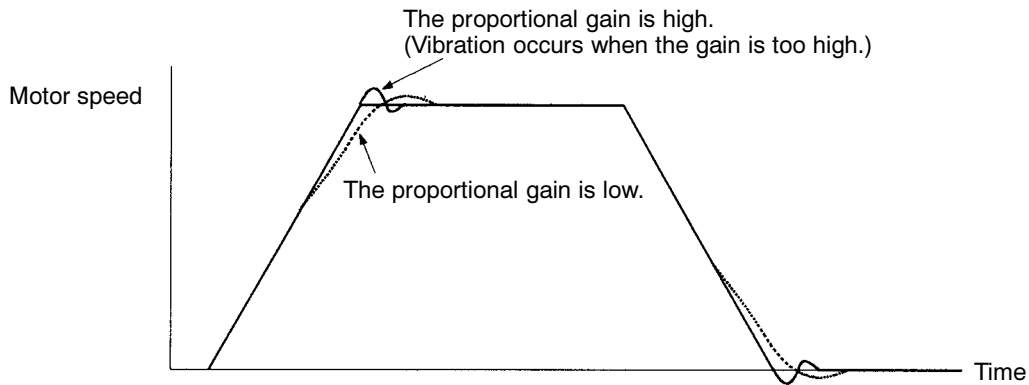

**• Adjusting ASR Integral Time 1 (C5-02)**

This parameter sets the speed control loop's integral time. Lengthening the integral time lowers the responsiveness, and weakens the resistance to external influences. Vibration will occur if this setting is too short.

The following diagram shows changes that occur in the response when the ASR integral time is changed.

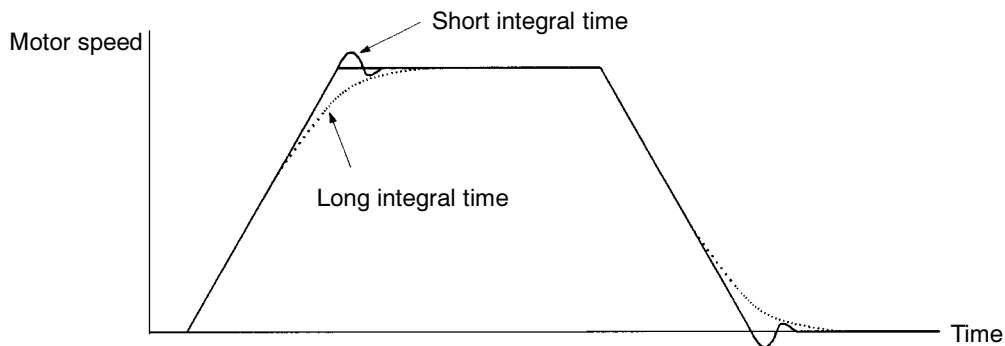

### ■ Different Gain Settings for Low-speed/High-speed

Switch between low-speed and high-speed gain when vibration occurs because of resonance with the mechanical system at low speed or high speed.

#### ● Setting the Gain Switching Frequency (C5-07)

Set the switching frequency to about 80% of the motor's operating frequency or the frequency at which vibration occurs.

#### ● Low-speed Gain Adjustments (C5-03 and C5-04)

- Connect the actual load and adjust these parameters at zero-speed.
- Increase ASR proportional gain 2 (C5-03) until there is no vibration.
- Decrease ASR integral time 2 (C5-04) until there is no vibration.

#### ● High-speed Gain Adjustments (C5-01 and C5-02)

- Adjust these parameters at normal operating speed.
- Increase ASR proportional gain 1 (C5-01) until there is no vibration.
- Decrease ASR integral time 1 (C5-02) until there is no vibration.
- Refer to *Fine Adjustments* on page 5-38 for details on making fine adjustments of high-speed operation.

## 5-5 V/f Control with PG

With V/f control with PG, the user must set the motor constants, V/f pattern, PG Control Card settings, and then adjust the speed control loop's gain.

### 5-5-1 Setting the Motor Constants

#### ■ Inverter Input Voltage Setting (E1-01)

Set the Inverter's input voltage (E1-01) to match the power supply voltage; it cannot be changed during operation. This setting is used as the reference value for functions such as the protection functions.

| Parameter number | Display name  | Setting range              | Units | Default setting | Valid access levels             |             |                  |             |
|------------------|---------------|----------------------------|-------|-----------------|---------------------------------|-------------|------------------|-------------|
|                  |               |                            |       |                 | V/f Control                     | V/f with PG | Open Loop Vector | Flux Vector |
| E1-01            | Input Voltage | 155 to 255<br>(310 to 510) | VAC   | 200<br>(400)    | Quick-start, Basic, or Advanced |             |                  |             |

**Note** The voltage settings shown in parentheses are the values for the 400-V class.

#### ■ Motor Selection and Rated Current Setting (E1-02 and E2-01)

Set the type of motor being used with the motor selection parameter (E1-02). This setting is a reference for the protection functions. This parameter cannot be changed during operation.

| Parameter number | Display name    | Setting range | Units | Default setting | Valid access levels             |             |                  |             |
|------------------|-----------------|---------------|-------|-----------------|---------------------------------|-------------|------------------|-------------|
|                  |                 |               |       |                 | V/f Control                     | V/f with PG | Open Loop Vector | Flux Vector |
| E1-02            | Motor Selection | 0 or 1        | ---   | 0               | Quick-start, Basic, or Advanced |             |                  |             |

#### E1-02 Settings

| Setting | Function  |
|---------|---|
| 0       | Standard fan-cooled motor (general-purpose motor)       |
| 1       | Standard blower-cooled motor (inverter-exclusive motor) |

Set parameter (E2-01) to rated current (A) shown on the motor's nameplate. This parameter cannot be changed during operation.

| Parameter number | Display name    | Setting range <sup>1</sup> | Units | Default setting <sup>2</sup> | Valid access levels             |             |                  |             |
|------------------|-----------------|----------------------------|-------|------------------------------|---------------------------------|-------------|------------------|-------------|
|                  |                 |                            |       |                              | V/f Control                     | V/f with PG | Open Loop Vector | Flux Vector |
| E2-01            | Motor Rated FLA | 10 to 200%                 | A     | (Note 2)                     | Quick-start, Basic, or Advanced |             |                  |             |

**Note 1.** The setting range is 10 to 200% of the Inverter's rated output current.

**Note 2.** The default setting depends upon the type of Inverter.

Set parameter (E2-04) to the number of poles shown on the motor's nameplate. This parameter cannot be changed during operation.

| Parameter number | Display name    | Setting range <sup>1</sup> | Units | Default setting <sup>2</sup> | Valid access levels |             |                  |             |
|------------------|-----------------|----------------------------|-------|------------------------------|---------------------|-------------|------------------|-------------|
|                  |                 |                            |       |                              | V/f Control         | V/f with PG | Open Loop Vector | Flux Vector |
| E2-04            | Number of Poles | 2 to 48                    | ---   | 4                            | ---                 | Quick-start | ---              | Quick-start |

## 5-5-2 V/f Pattern Selection (E1-03)

Set the V/f pattern with parameter E1-03. This parameter cannot be changed during operation.

| Parameter number | Display name  | Setting range | Units | Default setting | Valid access levels             |             |                  |             |
|------------------|---------------|---------------|-------|-----------------|---------------------------------|-------------|------------------|-------------|
|                  |               |               |       |                 | V/f Control                     | V/f with PG | Open Loop Vector | Flux Vector |
| E1-03            | V/f Selection | 0 to F        | ---   | F               | Quick-start, Basic, or Advanced |             | Not applicable.  |             |

The V/f pattern settings can be divided into two categories: the 15 preset patterns (settings 0 through E) and custom user-set patterns (setting F). The factory default setting for E1-03 is “F” (user-defined V/f pattern), but the contents of this setting are actually the same as setting “1.”

### ■ Selecting a Preset V/f Pattern (Settings “0” through “E”)

Refer to the following table when selecting one of the 15 preset patterns.

| Characteristics       | Applications  | Setting | Specifications                      |
|-----------------------|---|---------|-------------------------------------|
| General-purpose       | These patterns are for general-purpose applications.<br><br>Use these patterns when there is a roughly proportional relationship between the rotational speed and load, such as in straight-line conveyors. | 0       | 50 Hz                               |
|                       |   | 1       | 60 Hz                               |
|                       |   | 2       | 60 Hz, Voltage saturation at 50 Hz  |
|                       |   | 3       | 72 Hz, Voltage saturation at 60 Hz  |
| Variable torque       | Use these patterns when there is a quadratic or cubic relationship between the rotational speed and load, such as in fans or pumps.   | 4       | 50 Hz, cubic                        |
|                       |   | 5       | 50 Hz, quadratic                    |
|                       |   | 6       | 60 Hz, cubic                        |
|                       |   | 7       | 60 Hz, quadratic                    |
| High starting torque  | (Normally it isn't necessary to use these patterns because starting torque is ensured by automatic torque boost functions.)   | 8       | 50 Hz, low starting torque          |
|                       |   | 9       | 50 Hz, high starting torque         |
|                       |   | A       | 60 Hz, low starting torque          |
|                       |   | b       | 60 Hz, high starting torque         |
| High-speed operations | These patterns are for applications that must rotate at frequencies greater than 60 Hz. A fixed voltage is applied at frequencies greater than 60 Hz.   | C       | 90 Hz, Voltage saturation at 60 Hz  |
|                       |   | d       | 120 Hz, Voltage saturation at 60 Hz |
|                       |   | E       | 180 Hz, Voltage saturation at 60 Hz |

**Note 1.** Select a high starting torque V/f pattern only in the following cases:

- The wiring distance between the Inverter and motor is relatively large (greater than 150 m).
- A large torque is required at startup (such as heavy axis loads).
- An AC or DC reactor is connected to the Inverter's input or output.

**Note 2.** The parameter settings for E1-04 through E1-10 will be changed automatically when one of these patterns is selected. There are three possible settings for these parameters depending on the Inverter's capacity: a 0.4 to 1.5 kW V/f pattern, a 2.2 to 45 kW V/f pattern, and a 55 to 300 kW V/f pattern.

**Note 3.** The characteristics for these patterns are shown in the diagrams on pages 5-24 through 5-26.

### ■ Setting a User-defined V/f Pattern (Setting “F”)

Parameters E1-04 through E1-10 can be set by the user when E1-03 has been set to “F.” Refer to page 5-27 for details on setting these parameters.

### 5-5-3 PG Speed Control Card Settings

#### ■ Available PG Speed Control Cards

There are 4 types of PG Speed Control Cards, but only 2 types can be used with V/f control.

3G3FV-PPGA2: Phase-A (single) pulse input, input for open collector

3G3FV-PPGD2: Phase-A (single) pulse input, line driver inputs

Select the Card according to the application and install it in the Inverter as described in *2-2-6 Installing and Wiring PG Speed Control Cards*.

#### ■ Setting the PG Pulse Number (F1-01)

Set the PG (pulse generator or encoder) pulse number in pulses/revolution. Set the number of phase A or phase B pulses in one motor revolution. This parameter cannot be changed during operation.

| Parameter number | Display name  | Setting range | Units | Default setting | Valid access levels* |             |                  |             |
|------------------|---------------|---------------|-------|-----------------|----------------------|-------------|------------------|-------------|
|                  |               |               |       |                 | V/f Control          | V/f with PG | Open Loop Vector | Flux Vector |
| F1-01            | PG Pulses/Rev | 0 to 60,000   | p/r   | 1,000           | ---                  | Q           | ---              | Q           |

**Note** Q: Quick-start, Basic, or Advanced

---: Not applicable.

#### ■ Setting the Number of PG Gear Teeth (F1-12 and F1-13)

When “V/f control with PG feedback” is used, the motor can be operated even if there are gears between the motor and PG because the responsiveness is lower than it is with vector control.

Set the number of teeth on the gears if there are gears between the motor and PG. The motor’s speed will be calculated within the Inverter using the following equation:

$$\text{Motor speed (r/min)} = \frac{\text{Number of pulses input from the PG} \times 60}{\text{Number of PG pulses (F1-01)}} \times \frac{\text{Number of gear teeth 2 (F1-13)}}{\text{Number of gear teeth 1 (F1-12)}}$$

| Parameter number | Display name     | Setting range | Units | Default setting | Valid access levels <sup>1</sup> |             |                  |             |
|------------------|------------------|---------------|-------|-----------------|----------------------------------|-------------|------------------|-------------|
|                  |                  |               |       |                 | V/f Control                      | V/f with PG | Open Loop Vector | Flux Vector |
| F1-12            | PG # Gear Teeth1 | 0 to 1,000    | ---   | 0               | ---                              | A           | ---              | ---         |
| F1-13            | PG # Gear Teeth2 | 0 to 1,000    | ---   | 0               | ---                              | A           | ---              | ---         |

**Note** 1. A: Advanced

---: Not applicable.

**Note** 2. These parameters cannot be changed during operation.

**Note** 3. A gear ratio of 1 (F1-12 = F1-13 = 1) will be used if either of these parameters is set to 0.

#### ■ Selecting Integral Operation During Acceleration/Deceleration (F1-07)

When “V/f control with PG feedback” is used, integral control during acceleration and deceleration can be enabled or disabled with F1-07. This parameter cannot be changed during operation.



Set F1-07 to “1” (integral control enabled) if you want to keep the motor speed as close to the frequency reference as possible during acceleration and deceleration. Set F1-07 to “0” (integral control disabled) if you want to prevent the occurrence overshooting/undershooting.

| Parameter number | Display name     | Setting range | Units | Default setting | Valid access levels <sup>1</sup> |             |                  |             |
|------------------|------------------|---------------|-------|-----------------|----------------------------------|-------------|------------------|-------------|
|                  |                  |               |       |                 | V/f Control                      | V/f with PG | Open Loop Vector | Flux Vector |
| F1-07            | PG Ramp PI/I Sel | 0 or 1        | ---   | 0               | ---                              | B           | ---              | ---         |

**Note A:** Basic or Advanced  
 ---: Not applicable.

**Settings**

| Setting | Function  |
|---------|---|
| 0       | Disabled<br>(The integral function isn’t used while accelerating or decelerating; it is used at constant speeds.) |
| 1       | Enabled (The integral function is used at all times.)   |

■ **Setting and Adjusting the Fault Detection Functions**

● **PG Disconnection Stopping Method (F1-02)**

This parameter sets the stopping method that is used when the signal from the PG is lost.

| Parameter number | Display name     | Setting range | Units | Default setting | Valid access levels* |             |                  |             |
|------------------|------------------|---------------|-------|-----------------|----------------------|-------------|------------------|-------------|
|                  |                  |               |       |                 | V/f Control          | V/f with PG | Open Loop Vector | Flux Vector |
| F1-02            | PG Fdbk Loss Sel | 0 to 3        | ---   | 1               | ---                  | B           | ---              | B           |

**Note B:** Basic or Advanced  
 ---: Not applicable.

**Settings**

| Setting | Name          | Function  |
|---------|---------------|---|
| 0       | Ramp to Stop  | Deceleration stop using deceleration time 1 (C1-02).                        |
| 1       | Coast to Stop | Free-run stop   |
| 2       | Fast Stop     | Emergency stop using the fast-stop time (C1-09).                            |
| 3       | Alarm Only    | Continue operation (Display “PGO” and continue operation with V/f control.) |

● **Overspeed Settings (F1-03, F1-08, and F1-09)**

Overspeed refers to an excessive motor speed. These parameters set the conditions for an overspeed fault and the stopping method that is used when an overspeed fault occurs; they cannot be changed during operation.

Parameter F1-03 sets the stopping method that is used when an overspeed fault occurs.

| Parameter number | Display name     | Setting range | Units | Default setting | Valid access levels* |             |                  |             |
|------------------|------------------|---------------|-------|-----------------|----------------------|-------------|------------------|-------------|
|                  |                  |               |       |                 | V/f Control          | V/f with PG | Open Loop Vector | Flux Vector |
| F1-03            | PG Overspeed Sel | 0 to 3        | ---   | 1               | ---                  | B           | ---              | B           |

**Note B:** Basic or Advanced  
 ---: Not applicable.

**Settings**

| Setting | Name          | Function  |
|---------|---------------|---|
| 0       | Ramp to Stop  | Deceleration stop using deceleration time 1 (C1-02).    |
| 1       | Coast to Stop | Free-run stop   |
| 2       | Fast Stop     | Emergency stop using the fast-stop time (C1-09).        |
| 3       | Alarm Only    | Continue operation (Display “OS” and continue control.) |

Parameter F1-08 sets the overspeed detection level as a percentage of the maximum output frequency. Parameter F1-09 sets the length of time that the motor speed must exceed the overspeed detection level in order to generate an overspeed fault.

| Parameter number | Display name     | Setting range | Units | Default setting | Valid access levels* |             |                  |             |
|------------------|------------------|---------------|-------|-----------------|----------------------|-------------|------------------|-------------|
|                  |                  |               |       |                 | V/f Control          | V/f with PG | Open Loop Vector | Flux Vector |
| F1-08            | PG Overspd Level | 0 to 120      | %     | 115             | ---                  | A           | ---              | A           |
| F1-09            | PG Overspd Time  | 0.0 to 2.0    | s     | 0.0             | ---                  | A           | ---              | A           |

**Note A:** Advanced  
 ---: Not applicable.

● **PG Speed Deviation Settings (F1-04, F1-10, and F1-11)**

PG speed deviation refers to the difference between the actual motor speed and the reference command speed. These parameters set the conditions for a PG speed deviation fault and the stopping method that is used when a PG speed deviation fault occurs; they cannot be changed during operation.

Parameter F1-04 sets the stopping method that is used when a PG speed deviation fault occurs.

| Parameter number | Display name     | Setting range | Units | Default setting | Valid access levels* |             |                  |             |
|------------------|------------------|---------------|-------|-----------------|----------------------|-------------|------------------|-------------|
|                  |                  |               |       |                 | V/f Control          | V/f with PG | Open Loop Vector | Flux Vector |
| F1-04            | PG Deviation Sel | 0 to 3        | ---   | 3               | ---                  | B           | ---              | B           |

**Note B:** Basic or Advanced  
 ---: Not applicable.

**Settings**

| Setting | Name          | Function   |
|---------|---------------|--|
| 0       | Ramp to Stop  | Deceleration stop using deceleration time 1 (C1-02).     |
| 1       | Coast to Stop | Free-run stop  |
| 2       | Fast Stop     | Emergency stop using the fast-stop time (C1-09).         |
| 3       | Alarm Only    | Continue operation (Display “DEV” and continue control.) |

Parameter F1-10 sets the PG speed deviation detection level as a percentage of the maximum output frequency. Parameter F1-11 sets the length of time that the difference between the motor speed and reference speed must exceed the PG speed deviation detection level in order to generate a PG speed deviation fault (DEV).

| Parameter number | Display name     | Setting range | Units | Default setting | Valid access levels* |             |                  |             |
|------------------|------------------|---------------|-------|-----------------|----------------------|-------------|------------------|-------------|
|                  |                  |               |       |                 | V/f Control          | V/f with PG | Open Loop Vector | Flux Vector |
| F1-10            | PG Deviate Level | 0 to 50       | %     | 10              | ---                  | A           | ---              | A           |
| F1-11            | PG Deviate Time  | 0.0 to 10.0   | s     | 0.5             | ---                  | A           | ---              | A           |

**Note A:** Advanced  
 ---: Not applicable.

### 5-5-4 Speed Loop (ASR) Structure

The following block diagram shows the structure of the speed loop.

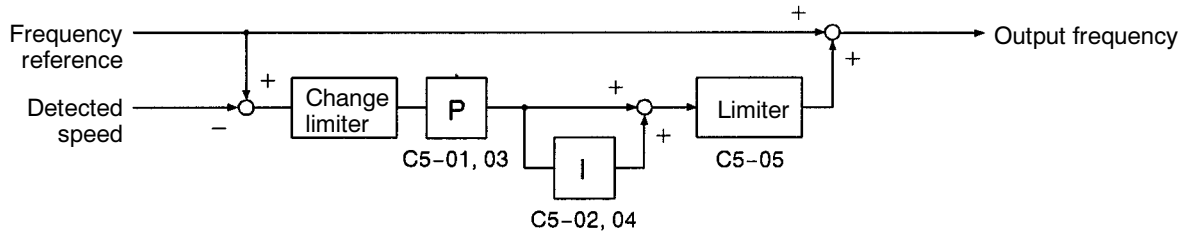

#### ■ Gain Settings

When using “V/f control with PG feedback,” set the gain at the minimum frequency and maximum frequency.

##### ● Max. Frequency Gain Settings (C5-01 and C5-02)

Set ASR proportional gain 1 (C5-01) and ASR integral time 1 (C5-02) at the maximum frequency.

| Parameter number | Display name | Setting range   | Units  | Default setting | Valid access levels* |             |                  |             |
|------------------|--------------|-----------------|--------|-----------------|----------------------|-------------|------------------|-------------|
|                  |              |                 |        |                 | V/f Control          | V/f with PG | Open Loop Vector | Flux Vector |
| C5-01            | ASR P Gain 1 | 0.00 to 300.00  | Factor | 0.20            | ---                  | B           | ---              | B           |
| C5-02            | ASR I Time 1 | 0.000 to 10.000 | s      | 0.200           | ---                  | B           | ---              | B           |

**Note B:** Basic or Advanced  
 ---: Not applicable.

##### ● Min. Frequency Gain Settings (C5-03 and C5-04)

Set ASR proportional gain 2 (C5-03) and ASR integral time 2 (C5-04) at the minimum frequency.

| Parameter number | Display name | Setting range   | Units  | Default setting | Valid access levels* |             |                  |             |
|------------------|--------------|-----------------|--------|-----------------|----------------------|-------------|------------------|-------------|
|                  |              |                 |        |                 | V/f Control          | V/f with PG | Open Loop Vector | Flux Vector |
| C5-03            | ASR P Gain 2 | 0.00 to 300.00  | Factor | 0.02            | ---                  | B           | ---              | B           |
| C5-04            | ASR I Time 2 | 0.000 to 10.000 | s      | 0.050           | ---                  | B           | ---              | B           |

**Note B:** Basic or Advanced  
 ---: Not applicable.

The following graph shows how the proportional gain and integral time are calculated from parameters C5-01 through C5-04.

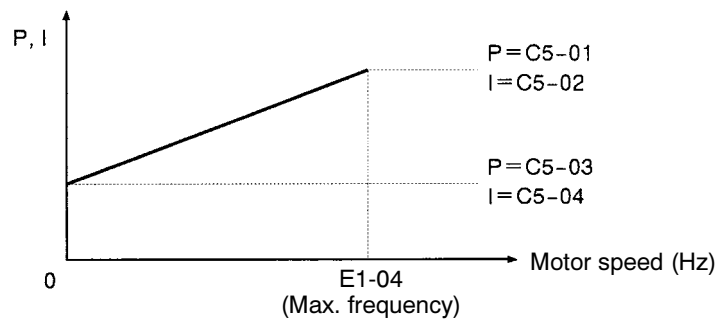

## ■ Multi-function Input Settings (H1-01 through H1-06)

### ● V/f Mode Select (Setting D)

When one of the multi-function inputs is set to “D,” the input can be used to enable and disable the speed control loop. The speed control loop is disabled (normal V/f control) when the multi-function input is ON.

### ● ASR Integral Reset (Setting E)

When one of the multi-function inputs is set to “E,” the input can be used to switch the speed control loop between P control and PI control. P control (integral reset) is used when the multi-function input is ON.

## 5-5-5 Adjusting Speed Control Loop (ASR) Gain

### ■ Gain Adjustment Procedure

Use the following procedure to adjust the gain with the mechanical system and actual load connected.

#### ● Gain Adjustments at Minimum Frequency

1. Operate the motor at the minimum frequency.
2. Increase C5-03 (ASR proportional gain 2) to a level where there is no vibration.
3. Decrease C5-04 (ASR integral time 2) to a level where there is no vibration.
4. Monitor the Inverter’s output current and verify that it is less than 50% of the Inverter’s rated current. If the output current exceeds 50% of the Inverter’s rated current, decrease C5-03 and increase C5-04.

#### ● Gain Adjustments at Maximum Frequency

1. Operate the motor at the maximum frequency.
2. Increase C5-01 (ASR proportional gain 1) to a level where there is no vibration.
3. Decrease C5-02 (ASR integral time 1) to a level where there is no vibration.

#### ● Gain Adjustments for Integral Control during Acceleration/Deceleration

Enable integral operation during acceleration and deceleration (with F1-07) when you want the motor’s speed to closely follow the frequency reference during acceleration and deceleration. Integral operation causes the speed to reach the target speed as fast as possible, but may result in overshooting or undershooting.

1. Set F1-07 to "1" to enable integral operation at all times.
2. Make the parameter settings shown below in order to observe the speed waveform while making fine adjustments to the gain.

| Parameter                                   | Setting | Explanation   |
|---|---------|---|
| H4-01 Analog output selection (terminal 21) | 21      | Settings that allow multi-function analog output 1 to be used to monitor the ASR input.   |
| H4-02 Analog output gain (terminal 21)      | 1.00    |   |
| H4-03 Analog output bias (terminal 21)      | 0.0     |   |
| H4-04 Analog output selection (terminal 23) | 5       | Settings that allow multi-function analog output 2 to be used to monitor the motor speed. |
| H4-05 Analog output gain (terminal 23)      | 1.00    |   |
| H4-06 Analog output bias (terminal 23)      | 0.0     |   |
| H4-07 Analog output level selection         | 1       | This setting allows a 0 to $\pm 10$ V signal range to be monitored.                       |

The multi-function analog outputs have the following functions with these parameter settings. Terminal 22 is the multi-function analog output common.

Multi-function analog output 1 (terminal 21): Outputs the Inverter's ASR input (0 to  $\pm 10$  V).

Multi-function analog output 2 (terminal 23): Outputs the actual motor speed (0 to  $\pm 10$  V).

We recommend monitoring both the ASR input and the motor speed in order to observe a response delay or deviation from the reference value, as shown in the following diagram.

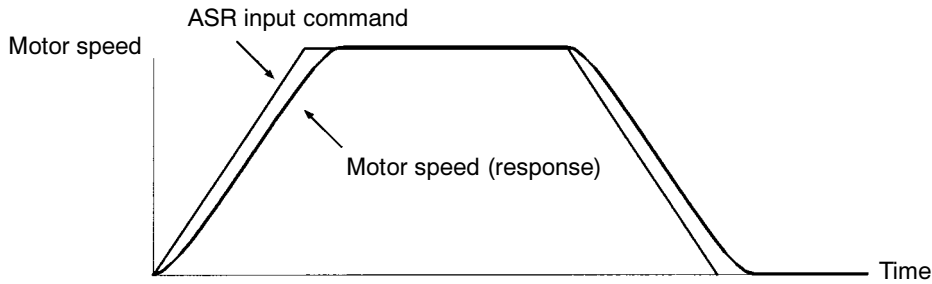

3. Give acceleration/deceleration commands and adjust the gain while observing the waveform.

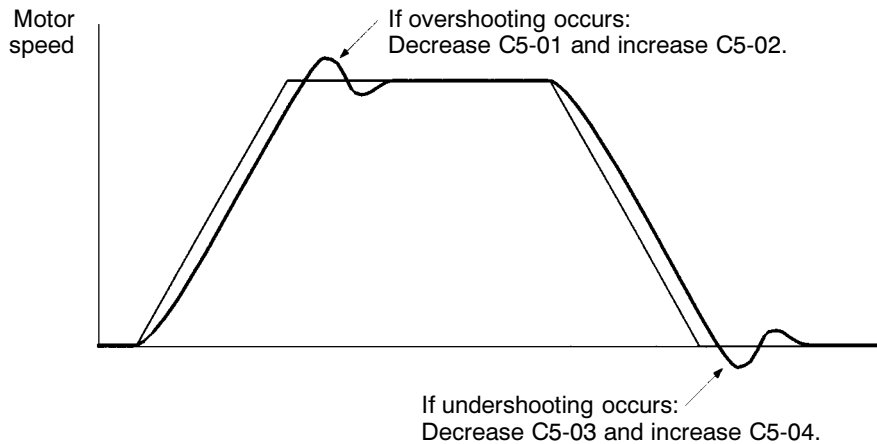

4. If the overshooting or undershooting can't be eliminated by adjusting the gain, decrease the ASR limit (C5-05) to lower the frequency reference compensation limit. Since C5-05 can't be changed during operation, stop the Inverter's operation and then decrease the ASR limit by 0.5 (%). Perform step 3 again after the setting has been changed.

The ASR limit is the frequency limit for compensation by speed control loop. Set this frequency limit as a percentage of the maximum output frequency. If the frequency limit is lowered too much, the

motor speed might not reach the target speed. Verify that the target speed is reached during normal operation.

| Parameter number | Display name | Setting range | Units | Default setting | Valid access levels* |             |                  |             |
|------------------|--------------|---------------|-------|-----------------|----------------------|-------------|------------------|-------------|
|                  |              |               |       |                 | V/f Control          | V/f with PG | Open Loop Vector | Flux Vector |
| C5-05            | ASR Limit    | 0.0 to 20.0   | %     | 5.0             | ---                  | A           | ---              | ---         |

**Note** A:     Advanced  
 ---:        Not applicable.

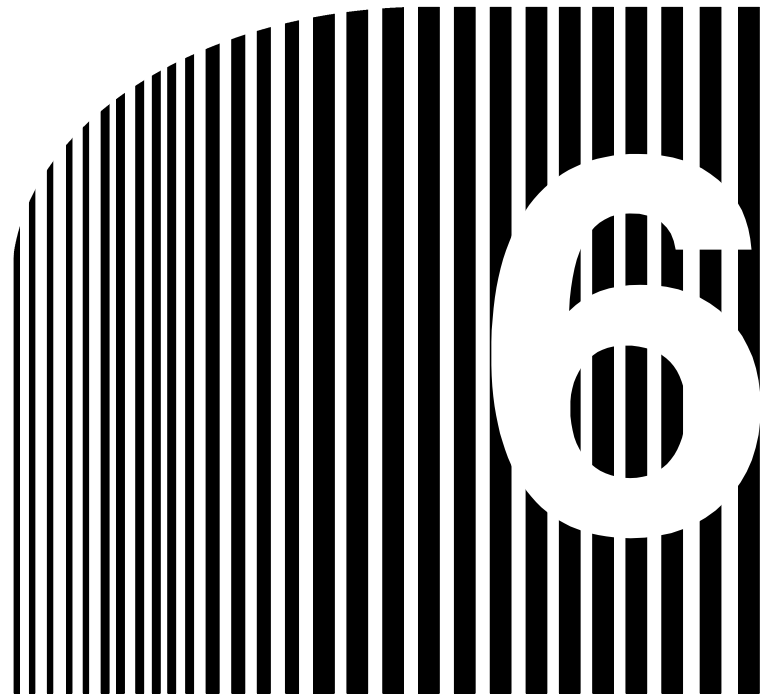

## Chapter 6

### • Advanced Operation •

- 6-1 Open-loop Vector Control
- 6-2 Normal V/f Control
- 6-3 Flux Vector Control
- 6-4 V/f Control With PG Feedback
- 6-5 Common Functions

## 6-1 Open-loop Vector Control

This section summarizes the functions that can be used with open-loop vector control (vector control without PG feedback) and then provides detailed explanations of the functions that are specific to open-loop vector control.

### 6-1-1 Summary of Open-loop Vector Control Functions

An “OK” in the control mode column indicates that the parameter can be changed in that control mode. The functions specific to open-loop vector control are marked with a “★” and described in more detail later in this section.

| Group       | Function |                  | Comments  | Control mode |          |                  |             |
|-------------|----------|------------------|---|--------------|----------|------------------|-------------|
|             |          |                  |   | V/f          | V/f w/PG | Open-loop Vector | Flux Vector |
| Application | b1       | Sequence         | Settings such as the reference input method   | OK           | OK       | OK               | OK          |
|             | b2       | DC Braking       | DC braking function settings  | OK           | OK       | OK               | OK          |
|             | b3       | Speed Search     | Speed search function settings  | OK           | OK       | OK               | OK          |
|             | b4       | Delay Timers     | Timer function settings   | OK           | OK       | OK               | OK          |
|             | b5       | PID Control      | PID control settings  | OK           | OK       | OK               | OK          |
|             | b6       | Reference Hold   | Accel/deceleration time dwell function settings                                     | OK           | OK       | OK               | OK          |
|             | b7       | ---              | Not used. (Can't be set.)   | ---          | ---      | ---              | OK          |
|             | b8       | Energy Saving    | Not used. (Can't be set.)   | OK           | OK       | ---              | ---         |
|             | b9       | Zero Servo       | Not used. (Can't be set.)   | ---          | ---      | ---              | OK          |
| Tuning      | C1       | Accel/Decel      | Acceleration/deceleration time settings   | OK           | OK       | OK               | OK          |
|             | C2       | S-Curve Acc/Dec  | S-curve characteristics for accel/decel times                                       | OK           | OK       | OK               | OK          |
|             | C3       | Motor-Slip Comp  | Slip compensation function settings   | OK           | OK       | OK               | OK          |
|             | C4       | Torque Comp      | Torque compensation function settings   | OK           | OK       | OK               | ---         |
|             | C5       | ASR Tuning       | Not used. (Can't be set.)   | ---          | OK       | ---              | OK          |
|             | C6       | Carrier Freq     | Carrier frequency settings  | OK           | OK       | OK               | OK          |
|             | C7       | Hunting Prev     | Not used. (Can't be set.)   | OK           | OK       | ---              | ---         |
|             | C8       | Factory Tuning   | ★ Adjustment for open-loop vector control   | ---          | ---      | OK               | ---         |
| Reference   | d1       | Preset Reference | Frequency reference settings (when using Operator)                                  | OK           | OK       | OK               | OK          |
|             | d2       | Reference Limits | Frequency upper and lower limit settings  | OK           | OK       | OK               | OK          |
|             | d3       | Jump Frequencies | Prohibited frequency settings   | OK           | OK       | OK               | OK          |
|             | d4       | Sequence         | Up/Down, Accel/Decel stop hold frequency setting                                    | OK           | OK       | OK               | OK          |
|             | d5       | Torque Control   | Not used. (Can't be set.)   | ---          | ---      | ---              | OK          |
| Motor       | E1       | V/f Pattern      | ★ Motor constant settings<br>(Motor constants are set by the auto-tuning function.) | OK           | OK       | OK               | OK          |
|             | E2       | Motor Setup      |   | OK           | OK       | OK               | OK          |
| Options     | F1       | PG Option Setup  | Not used. (Can't be set.)   | ---          | OK       | ---              | OK          |
|             | F2       | AI-14 Setup      | Parameter settings for an Analog Command Card                                       | OK           | OK       | OK               | OK          |
|             | F3       | DI-08, 16 Setup  | Parameter settings for a Digital Command Card                                       | OK           | OK       | OK               | OK          |
|             | F4       | AO-08, 12 Setup  | Parameter settings for an Analog Monitor Card                                       | OK           | OK       | OK               | OK          |
|             | F5       | DO-02 Setup      | Not Used. (Do not change these settings.)   | ---          | ---      | ---              | ---         |
|             | F6       | DO-08 Setup      |   |              |          |                  |             |
|             | F7       | PO-36F Setup     | Parameter settings for a Pulse Monitor Card   | OK           | OK       | OK               | OK          |
| Terminal    | H1       | Digital Inputs   | Function selection for multi-function inputs  | OK           | OK       | OK               | OK          |
|             | H2       | Digital Outputs  | Function selection for multi-function outputs                                       | OK           | OK       | OK               | OK          |
|             | H3       | Analog Inputs    | Adjustment/function selection for external analog inputs                            | OK           | OK       | OK               | OK          |
|             | H4       | Analog Outputs   | Adjustment/function selection for multi-function analog outputs                     | OK           | OK       | OK               | OK          |
|             | H5       | Serial Com Setup | Not Used. (Do not change this setting.)   | ---          | ---      | ---              | ---         |



| Group      | Function |                  | Comments  | Control mode |          |                  |             |
|------------|----------|------------------|---|--------------|----------|------------------|-------------|
|            |          |                  |   | V/f          | V/f w/PG | Open-loop Vector | Flux Vector |
| Protection | L1       | Motor Overload   | Sets electrical/thermal functions that protect the motor. | OK           | OK       | OK               | OK          |
|            | L2       | PwrLoss Ridethru | Selects the power-loss processing method.                 | OK           | OK       | OK               | OK          |
|            | L3       | Stall Prevention | Accel/Decel stall prevention settings and selection       | OK           | OK       | OK               | OK          |
|            | L4       | Ref Detection    | Frequency detection settings and selection                | OK           | OK       | OK               | OK          |
|            | L5       | Fault Restart    | Fault restart function settings                           | OK           | OK       | OK               | OK          |
|            | L6       | Torque Detection | Sets overtorque detection functions 1 and 2 (by torque)   | OK           | OK       | OK               | OK          |
|            | L7       | Torque Limit     | ★ Torque limit settings                                   | ---          | ---      | OK               | OK          |
|            | L8       | Hdwe Protection  | Hardware overheating and phase loss protection settings   | OK           | OK       | OK               | OK          |
| Operator   | o1       | Monitor Select   | Selects the Operator's display and setting methods.       | OK           | OK       | OK               | OK          |
|            | o2       | Key Selections   | Operator's key function selection and other parameters    | OK           | OK       | OK               | OK          |

## 6-1-2 Torque Limit Function

With open-loop vector control, the torque limit can be applied at an arbitrary value because the torque output by the motor is calculated internally.

The torque limit function is useful when the load cannot sustain a torque above a certain level or regenerative torque above a certain level. The two ways to apply a torque limit are listed below. (The lower torque limit will be used if both of these methods are set.)

- 1) Setting a torque limit with the parameters
- 2) Limiting torque with the analog inputs

The precision of the torque limit is  $\pm 5\%$  for output frequencies above 10 Hz, but the precision is lower for output frequencies below 10 Hz. Use flux vector control if you want to apply a torque limit at low-speed (below 10 Hz).

### ■ Setting a Torque Limit with Parameters

Torque limits can be set separately for the 4 ways that torque can be applied: forward torque, reverse torque, forward regenerative torque, and reverse forward regenerative torque. These parameters cannot be changed during operation.

| Parameter number | Display name         | Setting range | Units | Default setting | Valid access levels |             |                   |             |
|------------------|----------------------|---------------|-------|-----------------|---------------------|-------------|-------------------|-------------|
|                  |                      |               |       |                 | V/f Control         | V/f with PG | Open Loop Vector  | Flux Vector |
| L7-01            | Torque Limit Fwd     | 0 to 300      | %     | 200             | Not applicable      |             | Basic or Advanced |             |
| L7-02            | Torque Limit Rev     |               |       |                 |                     |             |                   |             |
| L7-03            | Torque Limit Fwd Rgn |               |       |                 |                     |             |                   |             |
| L7-04            | Torque Limit Rev Rgn |               |       |                 |                     |             |                   |             |

The following diagram shows the relationship between each parameter and the output torque.

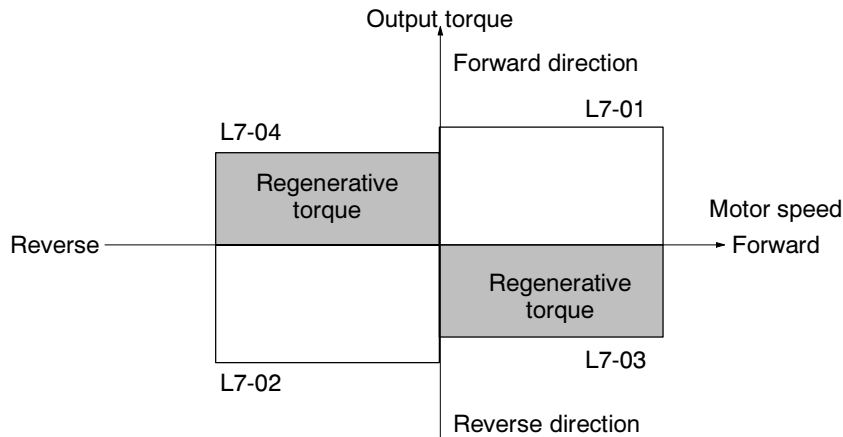

**Note** When the torque limit function is engaged the torque control has priority and motor speed control and compensation will be ignored, so the acceleration/deceleration times might be lengthened and motor speed might be reduced.

■ Limiting Torque with Analog Inputs

The following two analog inputs that can be used to limit torque.

- Multi-function analog input terminal 16
- Frequency reference (current) terminal 14

Use either or both of these inputs as needed with parameters H3-05 and H3-09. These parameters cannot be changed during operation.

| Parameter number | Display name    | Setting range | Units | Default setting | Valid access levels |             |                  |             |
|------------------|-----------------|---------------|-------|-----------------|---------------------|-------------|------------------|-------------|
|                  |                 |               |       |                 | V/f Control         | V/f with PG | Open Loop Vector | Flux Vector |
| H3-05            | Terminal 16 Sel | 0 to 1F       | ---   | 1F              | Basic or Advanced   |             |                  |             |
| H3-09            | Terminal 14 Sel | 1 to 1F       | ---   | 1F              | Advanced            |             |                  |             |

Settings

The following table shows only those settings related to the torque limit function.

| Setting | Name  |
|---------|---|
| 10      | Forward Torque Limit  |
| 11      | Reverse Torque Limit  |
| 12      | Regenerative Torque Limit   |
| 15      | Speed Limit (Limits torque in both the forward and reverse directions.) |

Set the analog input terminal’s signal level, gain, and bias to match the actual input signal. The factory default settings for the input terminal’s signal level are as follows:

- Terminal 16: 0 to 10 V (A 10-V input limits the torque to 100% of the motor’s rated torque.)
- Terminal 14: 4 to 20 mA (A 20-mA input limits the torque to 100% of the motor’s rated torque.)

The following diagram shows the relationship between the output torque and each torque limit.

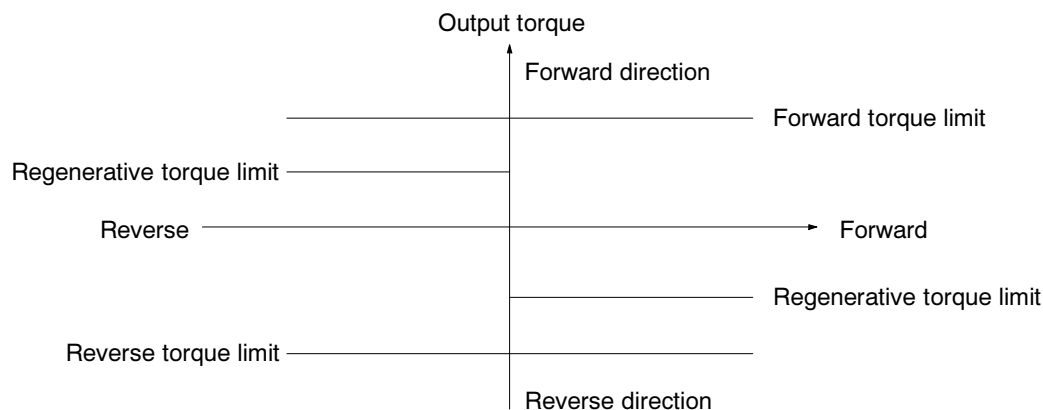

**Note 1.** When the forward torque limit has been set, the analog input signal acts as the limit value for torque generated in the forward direction. The torque limit input is effective when torque is generated in the forward direction even if the motor is operating in reverse (regenerative torque).

**Note 2.** The torque limit is 100% of the motor’s rated torque when the analog input is at its maximum value (10 V or 20 mA). To increase the torque limit above 100%, set the input terminal’s gain above 100%. For example, a gain of 150.0% would result in a torque limit of 150% of the motor’s rated torque with a 10-V or 20-mA analog input.

### 6-1-3 Adjusting Speed Feedback

With open-loop vector control, internal Inverter data is used to calculate the feedback value. The gain of this automatic frequency regulator (AFR) operation can be fine-tuned according to motor response. (Normally it isn’t necessary to change the default setting.)

| Parameter number | Display name | Setting range | Units  | Default setting | Valid access levels |             |                  |             |
|------------------|--------------|---------------|--------|-----------------|---------------------|-------------|------------------|-------------|
|                  |              |               |        |                 | V/f Control         | V/f with PG | Open Loop Vector | Flux Vector |
| C8-08            | AFR Gain     | 0.00 to 10.00 | Factor | 1.00            | ---                 | ---         | Advanced         | ---         |

**Note 1.** Normally it isn’t necessary to change this setting.

**Note 2.** Fine-tune the gain when motor operation is unstable causing hunting to occur or torque/speed responsiveness is low.

- When hunting occurs, increase the gain by 0.05 increments while checking the motor responsiveness.
- When responsiveness is low, decrease the gain by 0.05 increments while checking the motor responsiveness.

### 6-1-4 Setting/Adjusting Motor Constants

#### ■ Adjusting the V/f Pattern

Normally it isn't necessary to adjust the V/f pattern with open-loop vector control. Adjust the V/f pattern when you want to change the maximum frequency setting or decrease the Inverter's output voltage or when stalls are occurring during no-load operation. It is possible to make user-defined V/f pattern settings (E1-04 through E1-10) in open-loop vector control mode. (The preset V/f patterns cannot be selected.)

| Parameter number | Display name    | Setting range  | Units | Default setting | Valid access levels*1 |             |                  |             |
|------------------|-----------------|----------------|-------|-----------------|-----------------------|-------------|------------------|-------------|
|                  |                 |                |       |                 | V/f Control           | V/f with PG | Open Loop Vector | Flux Vector |
| E1-04            | Max Frequency   | 50.0 to 400.0  | Hz    | 60.0            | Q                     | Q           | Q                | Q           |
| E1-05            | Max Voltage     | 0.0 to 255.0*2 | VAC   | 200.0*2         | Q                     | Q           | Q                | Q           |
| E1-06            | Base Frequency  | 0.0 to 400.0   | Hz    | 60.0            | Q                     | Q           | Q                | Q           |
| E1-07            | Mid Frequency A | 0.0 to 400.0   | Hz    | 3.0*2           | Q                     | Q           | A                | ---         |
| E1-08            | Mid Voltage A   | 0.0 to 255.0*2 | VAC   | 11.0*2,3        | Q                     | Q           | A                | ---         |
| E1-09            | Min Frequency   | 0.0 to 400.0   | Hz    | 0.5             | Q                     | Q           | Q                | A           |
| E1-10            | Min Voltage     | 0.0 to 255.0*2 | VAC   | 2.0*2,3         | Q                     | Q           | A                | ---         |

**Note 1.** Q: Quick Start, Basic, or Advanced  
 A: Advanced only  
 ---: Not applicable.

**Note 2.** These voltages are for the 200-V class; Double the voltage for 400-V class Inverters.

**Note 3.** The default setting depends on the Inverter's capacity. The default settings shown in the table are for 200-V class, 0.4 to 1.5 kW Inverters.

**Note 4.** The default settings for E1-07 through E1-10 depend on the control mode. The default settings shown in the table are for open-loop vector control.

**Note 5.** The four frequency settings must satisfy the following formula:  
 $E1-04 (F_{MAX}) \geq E1-06 (F_A) > E1-07 (F_B) \geq E1-09 (F_{MIN})$

**Note 6.** When making the V/f characteristics a straight line, set the same value in E1-07 (middle output frequency) and E1-09 (minimum output frequency). In this case, parameter E1-08 (middle output voltage) will be ignored.

#### User-defined V/f Pattern

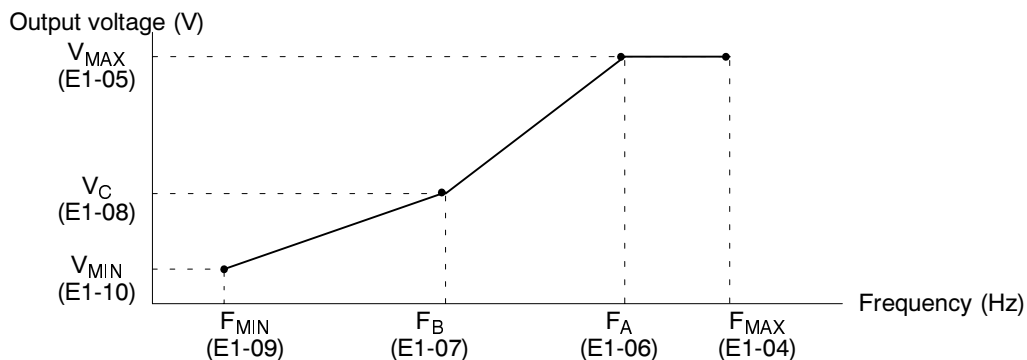

● **Adjusting Output Voltage**

Adjust the output voltage when you want to output more torque at low speed, such as in an elevator, or when torque isn't really necessary and you want to reduce the output voltage to save energy.

- When generating more torque, gradually increase the voltage but do not exceed 80% of the Inverter's rated output current.
- When saving energy, decrease the voltage but do not cause stalling.

● **Setting the Maximum Frequency**

The maximum frequency can be set from 50.0 to 400.0 Hz. Set this parameter in accordance with the motor's maximum rotational speed.

■ **Setting Motor Constants**

The motor constants (function E2) will all be set automatically when auto-tuning is performed, so it normally isn't necessary to set them manually. Set these parameters manually if auto-tuning can't be completed properly. These parameters cannot be changed during operation.

Set the rated current (A) shown on the motor's nameplate.

| Parameter number | Display name    | Setting range | Units | Default setting* | Valid access levels             |             |                  |             |
|------------------|-----------------|---------------|-------|------------------|---------------------------------|-------------|------------------|-------------|
|                  |                 |               |       |                  | V/f Control                     | V/f with PG | Open Loop Vector | Flux Vector |
| E2-01            | Motor Rated FLA | 0.32 to 6.40  | A     | 1.90             | Quick Start, Basic, or Advanced |             |                  |             |

**Note** The setting range is 10% to 200% of the Inverter's rated output current. The default setting depends upon the type of Inverter. (The table shows the default setting for 200-V class, 0.4-kW Inverters.)

Calculate the rated slip (E2-02) from the value shown on the motor's nameplate with the following equation and set this value.

$$\text{Rated slip} = \text{rated frequency (Hz)} - \text{rated speed (r/min)} \times \text{number of poles}/120$$

Set the no-load current (E2-03) at the rated voltage and rated frequency. Normally this value isn't shown on the motor's nameplate, so it might be necessary to contact the motor manufacturer.

| Parameter number | Display name     | Setting range  | Units | Default setting* | Valid access levels |             |                                 |             |
|------------------|------------------|----------------|-------|------------------|---------------------|-------------|---------------------------------|-------------|
|                  |                  |                |       |                  | V/f Control         | V/f with PG | Open Loop Vector                | Flux Vector |
| E2-02            | Motor Rated Slip | 0.00 to 20.00  | Hz    | 2.90             | Advanced            |             | Quick Start, Basic, or Advanced |             |
| E2-03            | No-Load Current  | 0.00 to 1500.0 | A     | 1.20             |                     |             |                                 |             |

**Note** The default setting depends upon the type of Inverter. (The table shows the default settings for 200-V class, 0.4-kW Inverters.)

Set the motor's terminal resistance (phase to phase) in parameter E2-05. Normally this value isn't shown on the motor's nameplate, so it might be necessary to contact the motor manufacturer for the terminal resistance at the insulation class temperature. Use the following equation to calculate the resistance value from the terminal resistance at the insulation class temperature ( $T_{IL}$ ).

$$\text{Motor terminal resistance } (\Omega) = \text{Terminal resistance at } T_{IL} (\Omega) \times \frac{273^\circ\text{C} + (25^\circ\text{C} + T_{IL})}{273^\circ\text{C} + T_{IL}}$$

The insulation class temperatures ( $T_{IL}$ ) are as follows:

A-type = 105°C, B-type = 120°C, F-type = 155°C, and H-type = 180°C

| Parameter number | Display name    | Setting range   | Units | Default setting | Valid access levels |             |                  |             |
|------------------|-----------------|-----------------|-------|-----------------|---------------------|-------------|------------------|-------------|
|                  |                 |                 |       |                 | V/f Control         | V/f with PG | Open Loop Vector | Flux Vector |
| E2-05            | Term Resistance | 0.000 to 65.000 | Ω     | 9.842           | Advanced            |             |                  |             |

**Note** The default setting depends upon the type of Inverter.

(The table shows the default settings for 200-V class, 0.4-kW Inverters.)

Set the voltage drop (caused by the motor’s leakage inductance) as a percentage of the motor’s rated voltage in parameter E2-06. Normally this value isn’t shown on the motor’s nameplate, so it might be necessary to contact the motor manufacturer.

It is also acceptable to set the loss (caused by the motor’s leakage inductance) as a percentage.

| Parameter number | Display name    | Setting range | Units | Default setting | Valid access levels |             |                  |             |
|------------------|-----------------|---------------|-------|-----------------|---------------------|-------------|------------------|-------------|
|                  |                 |               |       |                 | V/f Control         | V/f with PG | Open Loop Vector | Flux Vector |
| E2-06            | Leak Inductance | 0.0 to 30.0   | %     | 18.2            | Not applicable.     |             | Advanced         |             |

**Note** The default setting depends upon the type of Inverter.

(The table shows the default settings for 200-V class, 0.4-kW Inverters.)

Parameters E2-07 and E2-08 are used in a frequency range even higher than the motor’s rated frequency. It isn’t necessary to set these parameters when operating below the motor’s rated frequency. Set the following values:

Motor core-saturation coefficient 1: Core-saturation coefficient when magnetic flux is 50%.

Motor core-saturation coefficient 2: Core-saturation coefficient when magnetic flux is 75%.

Normally these values aren’t shown on the motor’s nameplate, so it might be necessary to contact the motor manufacturer.

| Parameter number | Display name      | Setting range | Units | Default setting | Valid access levels |             |                  |             |
|------------------|-------------------|---------------|-------|-----------------|---------------------|-------------|------------------|-------------|
|                  |                   |               |       |                 | V/f Control         | V/f with PG | Open Loop Vector | Flux Vector |
| E2-07            | Saturation Comp 1 | 0.0 to 0.50   | ---   | 0.50            | Not applicable.     |             | Advanced         |             |
| E2-08            | Saturation Comp 2 | 0.00 to 0.75  | ---   | 0.75            |                     |             |                  |             |

**Note** It is possible to operate the motor with the default settings, but motor efficiency may decrease.

## 6-2 Normal V/f Control

This section summarizes the functions that can be used with normal V/f control (V/f control without PG feedback) and then provides detailed explanations of the functions that are specific to normal V/f control.

### 6-2-1 Summary of V/f Control Functions

An “OK” in the control mode column indicates that the parameter can be changed in that control mode. The functions specific to normal V/f control are marked with a “★” and described in more detail later in this section.

| Group       | Function |                  | Comments  | Control mode |          |                  |             |
|-------------|----------|------------------|---|--------------|----------|------------------|-------------|
|             |          |                  |   | V/f          | V/f w/PG | Open-loop Vector | Flux Vector |
| Application | b1       | Sequence         | Settings such as the reference input method                     | OK           | OK       | OK               | OK          |
|             | b2       | DC Braking       | DC braking function settings                                    | OK           | OK       | OK               | OK          |
|             | b3       | Speed Search     | Speed search function settings                                  | OK           | OK       | OK               | OK          |
|             | b4       | Delay Timers     | Timer function settings   | OK           | OK       | OK               | OK          |
|             | b5       | PID Control      | PID control settings  | OK           | OK       | OK               | OK          |
|             | b6       | Reference Hold   | Accel/deceleration time dwell function settings                 | OK           | OK       | OK               | OK          |
|             | b7       | ---              | Not used. (Can't be set.)                                       | ---          | ---      | ---              | OK          |
|             | b8       | Energy Saving    | ★ Multi-function input: Energy-saving control settings          | OK           | OK       | ---              | ---         |
|             | b9       | Zero Servo       | Not used. (Can't be set.)                                       | ---          | ---      | ---              | OK          |
| Tuning      | C1       | Accel/Decel      | Acceleration/deceleration time settings                         | OK           | OK       | OK               | OK          |
|             | C2       | S-Curve Acc/Dec  | S-curve characteristics for accel/decel times                   | OK           | OK       | OK               | OK          |
|             | C3       | Motor-Slip Comp  | Slip compensation function settings                             | OK           | OK       | OK               | OK          |
|             | C4       | Torque Comp      | Torque compensation function settings                           | OK           | OK       | OK               | ---         |
|             | C5       | ASR Tuning       | Not used. (Can't be set.)                                       | ---          | OK       | ---              | OK          |
|             | C6       | Carrier Freq     | Carrier frequency settings                                      | OK           | OK       | OK               | OK          |
|             | C7       | Hunting Prev     | ★ Hunting prevention function settings                          | OK           | OK       | ---              | ---         |
|             | C8       | Factory Tuning   | Not used. (Can't be set.)                                       | ---          | ---      | OK               | ---         |
| Reference   | d1       | Preset Reference | Frequency reference settings (when using Operator)              | OK           | OK       | OK               | OK          |
|             | d2       | Reference Limits | Frequency upper and lower limit settings                        | OK           | OK       | OK               | OK          |
|             | d3       | Jump Frequencies | Prohibited frequency settings                                   | OK           | OK       | OK               | OK          |
|             | d4       | Sequence         | Up/Down, Accel/Decel stop hold frequency setting                | OK           | OK       | OK               | OK          |
|             | d5       | Torque Control   | Not used. (Can't be set.)                                       | ---          | ---      | ---              | OK          |
| Motor       | E1       | V/f Pattern      | ★ Motor constant settings<br>(Motor constants set manually.)    | OK           | OK       | OK               | OK          |
|             | E2       | Motor Setup      |   | OK           | OK       | OK               | OK          |
| Options     | F1       | PG Option Setup  | Not used. (Can't be set.)                                       | ---          | OK       | ---              | OK          |
|             | F2       | AI-14 Setup      | Parameter settings for an Analog Command Card                   | OK           | OK       | OK               | OK          |
|             | F3       | DI-08, 16 Setup  | Parameter settings for a Digital Command Card                   | OK           | OK       | OK               | OK          |
|             | F4       | AO-08, 12 Setup  | Parameter settings for an Analog Monitor Card                   | OK           | OK       | OK               | OK          |
|             | F5       | DO-02 Setup      | Not Used. (Do not change these settings.)                       | ---          | ---      | ---              | ---         |
|             | F6       | DO-08 Setup      |   |              |          |                  |             |
|             | F7       | PO-36F Setup     | Parameter settings for a Pulse Monitor Card                     | OK           | OK       | OK               | OK          |
| Terminal    | H1       | Digital Inputs   | Function selection for multi-function inputs                    | OK           | OK       | OK               | OK          |
|             | H2       | Digital Outputs  | Function selection for multi-function outputs                   | OK           | OK       | OK               | OK          |
|             | H3       | Analog Inputs    | Adjustment/function selection for external analog inputs        | OK           | OK       | OK               | OK          |
|             | H4       | Analog Outputs   | Adjustment/function selection for multi-function analog outputs | OK           | OK       | OK               | OK          |
|             | H5       | Serial Com Setup | Not Used. (Do not change this setting.)                         | ---          | ---      | ---              | ---         |

| Group      | Function |                  | Comments  | Control mode |          |                  |             |
|------------|----------|------------------|---|--------------|----------|------------------|-------------|
|            |          |                  |   | V/f          | V/f w/PG | Open-loop Vector | Flux Vector |
| Protection | L1       | Motor Overload   | Sets electrical/thermal functions that protect the motor. | OK           | OK       | OK               | OK          |
|            | L2       | PwrLoss Ridethru | Selects the power-loss processing method.                 | OK           | OK       | OK               | OK          |
|            | L3       | Stall Prevention | Accel/Decel/Run stall prevention settings and selection   | OK           | OK       | OK               | OK          |
|            | L4       | Ref Detection    | Frequency detection settings and selection                | OK           | OK       | OK               | OK          |
|            | L5       | Fault Restart    | Fault restart function settings                           | OK           | OK       | OK               | OK          |
|            | L6       | Torque Detection | Sets overtorque detection functions 1 and 2 (by current)  | OK           | OK       | OK               | OK          |
|            | L7       | Torque Limit     | Not used. (Can't be set.)                                 | ---          | ---      | OK               | OK          |
|            | L8       | Hdwe Protection  | Hardware overheating and phase loss protection settings   | OK           | OK       | OK               | OK          |
| Operator   | o1       | Monitor Select   | Selects the Operator's display and setting methods.       | OK           | OK       | OK               | OK          |
|            | o2       | Key Selections   | Operator's key function selection and other parameters    | OK           | OK       | OK               | OK          |

### 6-2-2 Energy-saving Control Function

The energy-saving control function is enabled when the energy-saving command (setting 63) has been set in a multi-function input (H1-01 through H1-06). Inputting the energy-saving command while there is a light load causes the Inverter's output voltage to be reduced and saves energy. Turn OFF the energy-saving command when a normal load is added.

Parameter b8-01 determines the Inverter's output voltage when the energy-saving command is input. Set this value as a percentage of the V/f pattern's voltage. Parameter L2-04 (the voltage recovery time) determines the rate at which the output voltage is changed when the energy-saving command is turned ON or OFF.

Parameter b8-02 determines the lower limit frequency for the energy-saving function. The energy-saving command is enabled only when the frequency reference is above this lower-limit and the motor speed is within the "speed agree" range.

Parameters b8-01 and b8-02 cannot be changed during operation.

| Parameter number | Display name     | Setting range | Units | Default setting | Valid access levels |             |                  |             |
|------------------|------------------|---------------|-------|-----------------|---------------------|-------------|------------------|-------------|
|                  |                  |               |       |                 | V/f Control         | V/f with PG | Open Loop Vector | Flux Vector |
| b8-01            | Energy Save Gain | 0 to 100      | %     | 80              | Advanced            |             | Not applicable.  |             |
| b8-02            | Energy Save Freq | 0.0 to 400.0  | Hz    | 0.0             |                     |             |                  |             |



Timing Chart

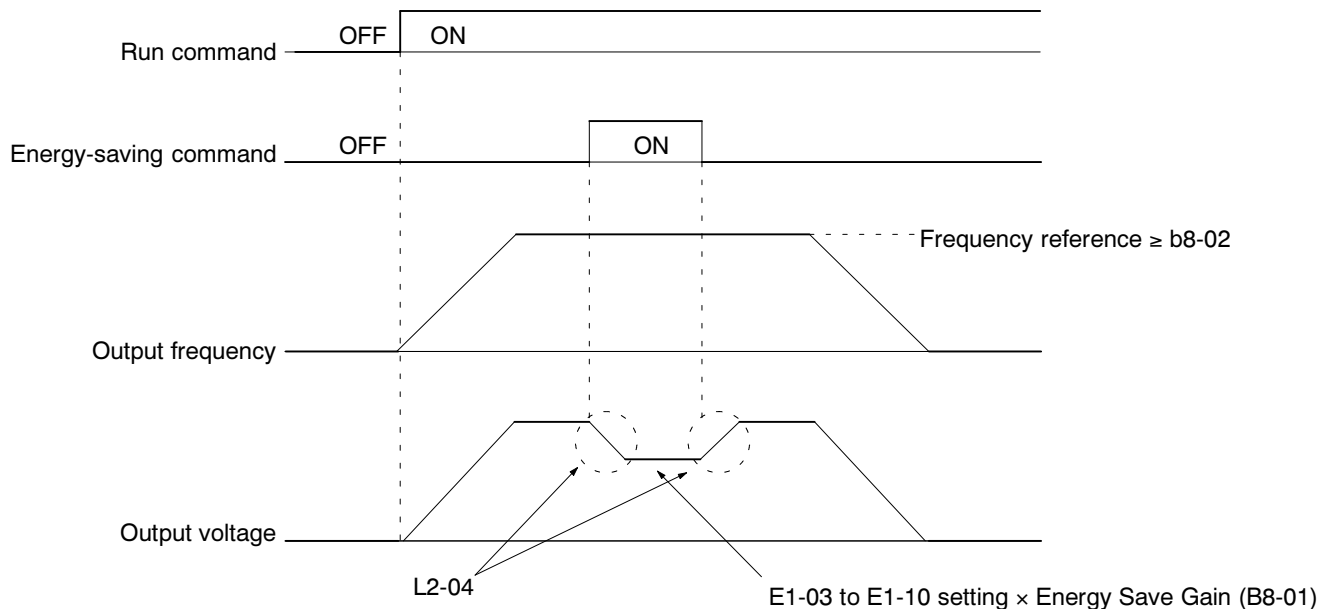

6-2-3 Hunting-prevention Function

The hunting-prevention function suppresses hunting when the motor is operating with a light load. This function is valid with V/f control and V/f with PG control. Parameters C7-01 and C7-02 cannot be changed during operation.

| Parameter number | Display name     | Setting range | Units | Default setting | Valid access levels |             |                  |             |
|------------------|------------------|---------------|-------|-----------------|---------------------|-------------|------------------|-------------|
|                  |                  |               |       |                 | V/f Control         | V/f with PG | Open Loop Vector | Flux Vector |
| C7-01            | Hung Prev Select | 0, 1          | ---   | 1               | Advanced            |             | Not applicable.  |             |

C7-01 Settings

| Setting | Function                                  |
|---------|---|
| 0       | Disables the hunting-prevention function. |
| 1       | Enables the hunting-prevention function.  |

| Parameter number | Display name   | Setting range | Units  | Default setting | Valid access levels |             |                  |             |
|------------------|----------------|---------------|--------|-----------------|---------------------|-------------|------------------|-------------|
|                  |                |               |        |                 | V/f Control         | V/f with PG | Open Loop Vector | Flux Vector |
| C7-02            | Hung Prev Gain | 0.00 to 2.50  | Factor | 1.00            | Advanced            |             | Not applicable.  |             |

Normally it isn't necessary to change these parameters. Adjust these parameters as follows if hunting occurs with a light load.

- Increase the setting in C7-02 if vibration occurs when operating with a light load. (If the setting is increased too much, the current can fall to the point where stalling occurs.)
- Decrease the setting in C7-02 if stalling occurs.
- Disable the hunting-prevention function (C7-01 = 0) if high responsiveness is more important than suppressing vibration.

### 6-2-4 Setting Motor Constants

The motor constants other than the V/f pattern parameters are described below:

Calculate the rated slip (E2-02) from the value shown on the motor’s nameplate with the following equation and set this value.

$$\text{Rated slip} = \text{rated frequency (Hz)} - \text{rated speed (r/min)} \times \text{number of poles}/120$$

Set the no-load current (E2-03) at the rated voltage and rated frequency. Normally this value isn’t shown on the motor’s nameplate, so it might be necessary to contact the motor manufacturer.

| Parameter number | Display name     | Setting range  | Units | Default setting* | Valid access levels |             |                                 |             |
|------------------|------------------|----------------|-------|------------------|---------------------|-------------|---------------------------------|-------------|
|                  |                  |                |       |                  | V/f Control         | V/f with PG | Open Loop Vector                | Flux Vector |
| E2-02            | Motor Rated Slip | 0.00 to 20.00  | Hz    | 2.90             | Advanced            |             | Quick Start, Basic, or Advanced |             |
| E2-03            | No-Load Current  | 0.00 to 1500.0 | A     | 1.20             |                     |             |                                 |             |

**Note 1.** The default setting depends upon the type of Inverter.  
(The table shows the default settings for 200-V class, 0.4-kW Inverters.)

**Note 2.** These settings are used as reference values for the motor slip compensation function.

Set the motor’s terminal resistance (phase to phase) in parameter E2-05. Normally this value isn’t shown on the motor’s nameplate, so it might be necessary to contact the motor manufacturer.

| Parameter number | Display name    | Setting range   | Units | Default setting | Valid access levels |             |                  |             |
|------------------|-----------------|-----------------|-------|-----------------|---------------------|-------------|------------------|-------------|
|                  |                 |                 |       |                 | V/f Control         | V/f with PG | Open Loop Vector | Flux Vector |
| E2-05            | Term Resistance | 0.000 to 65.000 | Ω     | 9.842           | Advanced            |             |                  |             |

**Note 1.** The default setting depends upon the type of Inverter.  
(The table shows the default settings for 200-V class, 0.4-kW Inverters.)

**Note 2.** This setting is used as a reference value for the torque compensation function.

## 6-3 Flux Vector Control

This section summarizes the functions that can be used with flux vector control (vector control with PG feedback) and then provides detailed explanations of the functions that are specific to flux vector control.

### 6-3-1 Summary of Flux Vector Control Functions

An “OK” in the control mode column indicates that the parameter can be changed in that control mode. The functions specific to normal V/f control are marked with a “★” and described in more detail later in this section.

| Group       | Function |                  | Comments   | Control mode |          |                  |             |
|-------------|----------|------------------|--|--------------|----------|------------------|-------------|
|             |          |                  |  | V/f          | V/f w/PG | Open-loop Vector | Flux Vector |
| Application | b1       | Sequence         | Settings such as the reference input method  | OK           | OK       | OK               | OK          |
|             | b2       | DC Braking       | DC braking function settings   | OK           | OK       | OK               | OK          |
|             | b3       | Speed Search     | Speed search function settings   | OK           | OK       | OK               | OK          |
|             | b4       | Delay Timers     | Timer function settings  | OK           | OK       | OK               | OK          |
|             | b5       | PID Control      | PID control settings   | OK           | OK       | OK               | OK          |
|             | b6       | Reference Hold   | Accel/deceleration time dwell function settings                                    | OK           | OK       | OK               | OK          |
|             | b7       | Droop Control    | ★ Droop Control function settings  | ---          | ---      | ---              | OK          |
|             | b8       | Energy Saving    | Not used. (Can't be set.)  | OK           | OK       | ---              | ---         |
|             | b9       | Zero Servo       | ★ Zero-servo function settings   | ---          | ---      | ---              | OK          |
| Tuning      | C1       | Accel/Decel      | Acceleration/deceleration time settings  | OK           | OK       | OK               | OK          |
|             | C2       | S-Curve Acc/Dec  | S-curve characteristics for accel/decel times                                      | OK           | OK       | OK               | OK          |
|             | C3       | Motor-Slip Comp  | ★ Motor temperature compensation function adjustment                               | OK           | OK       | OK               | OK          |
|             | C4       | Torque Comp      | Not used. (Can't be set.)  | OK           | OK       | OK               | ---         |
|             | C5       | ASR Tuning       | Speed control loop adjustment  | ---          | OK       | ---              | OK          |
|             | C6       | Carrier Freq     | Carrier frequency settings   | OK           | OK       | OK               | OK          |
|             | C7       | Hunting Prev     | Not used. (Can't be set.)  | OK           | OK       | ---              | ---         |
|             | C8       | Factory Tuning   | Not used. (Can't be set.)  | ---          | ---      | OK               | ---         |
| Reference   | d1       | Preset Reference | Frequency reference settings (when using Operator)                                 | OK           | OK       | OK               | OK          |
|             | d2       | Reference Limits | Frequency upper and lower limit settings   | OK           | OK       | OK               | OK          |
|             | d3       | Jump Frequencies | Prohibited frequency settings  | OK           | OK       | OK               | OK          |
|             | d4       | Sequence         | Up/Down, Accel/Decel stop hold frequency setting                                   | OK           | OK       | OK               | OK          |
|             | d5       | Torque Control   | ★ Torque control settings and adjustment   | ---          | ---      | ---              | OK          |
| Motor       | E1       | V/f Pattern      | ★ Motor constant settings<br>(Motor constants set automatically with auto-tuning.) | OK           | OK       | OK               | OK          |
|             | E2       | Motor Setup      |  | OK           | OK       | OK               | OK          |
| Options     | F1       | PG Option Setup  | Parameter settings for a PG Speed Control Card                                     | ---          | OK       | ---              | OK          |
|             | F2       | AI-14 Setup      | Parameter settings for an Analog Command Card                                      | OK           | OK       | OK               | OK          |
|             | F3       | DI-08, 16 Setup  | Parameter settings for a Digital Command Card                                      | OK           | OK       | OK               | OK          |
|             | F4       | AO-08, 12 Setup  | Parameter settings for an Analog Monitor Card                                      | OK           | OK       | OK               | OK          |
|             | F5       | DO-02 Setup      | Not Used. (Do not change these settings.)  | ---          | ---      | ---              | ---         |
|             | F6       | DO-08 Setup      |  |              |          |                  |             |
|             | F7       | PO-36F Setup     | Parameter settings for a Pulse Monitor Card  | OK           | OK       | OK               | OK          |
| Terminal    | H1       | Digital Inputs   | Function selection for multi-function inputs                                       | OK           | OK       | OK               | OK          |
|             | H2       | Digital Outputs  | Function selection for multi-function outputs                                      | OK           | OK       | OK               | OK          |
|             | H3       | Analog Inputs    | Adjustment/function selection for external analog inputs                           | OK           | OK       | OK               | OK          |
|             | H4       | Analog Outputs   | Adjustment/function selection for multi-function analog outputs                    | OK           | OK       | OK               | OK          |
|             | H5       | Serial Com Setup | Not Used. (Do not change this setting.)  | ---          | ---      | ---              | ---         |

| Group      | Function |                  | Comments  | Control mode |          |                  |             |
|------------|----------|------------------|---|--------------|----------|------------------|-------------|
|            |          |                  |   | V/f          | V/f w/PG | Open-loop Vector | Flux Vector |
| Protection | L1       | Motor Overload   | Sets electrical/thermal functions that protect the motor. | OK           | OK       | OK               | OK          |
|            | L2       | PwrLoss Ridethru | Selects the power-loss processing method.                 | OK           | OK       | OK               | OK          |
|            | L3       | Stall Prevention | Accel/Decel stall prevention settings and selection       | OK           | OK       | OK               | OK          |
|            | L4       | Ref Detection    | Frequency detection settings and selection                | OK           | OK       | OK               | OK          |
|            | L5       | Fault Restart    | Fault restart function settings                           | OK           | OK       | OK               | OK          |
|            | L6       | Torque Detection | Sets overtorque detection functions 1 and 2 (by current)  | OK           | OK       | OK               | OK          |
|            | L7       | Torque Limit     | ★ Torque limit function settings                          | ---          | ---      | OK               | OK          |
|            | L8       | Hdwe Protection  | Hardware overheating and phase loss protection settings   | OK           | OK       | OK               | OK          |
| Operator   | o1       | Monitor Select   | Selects the Operator's display and setting methods.       | OK           | OK       | OK               | OK          |
|            | o2       | Key Selections   | Operator's key function selection and other parameters    | OK           | OK       | OK               | OK          |

### 6-3-2 Droop Control Function

Droop control is a function that allows the user to set the amount of motor slip. When a single load is operated with two motors (such as in a crane conveyor), a high-resistance motor (a motor in which the secondary winding's resistance is increased resulting in an increased amount of slip) is normally used to adjust the load balance, as shown in the following diagram.

The balance of the load is very different with different amounts of slip.

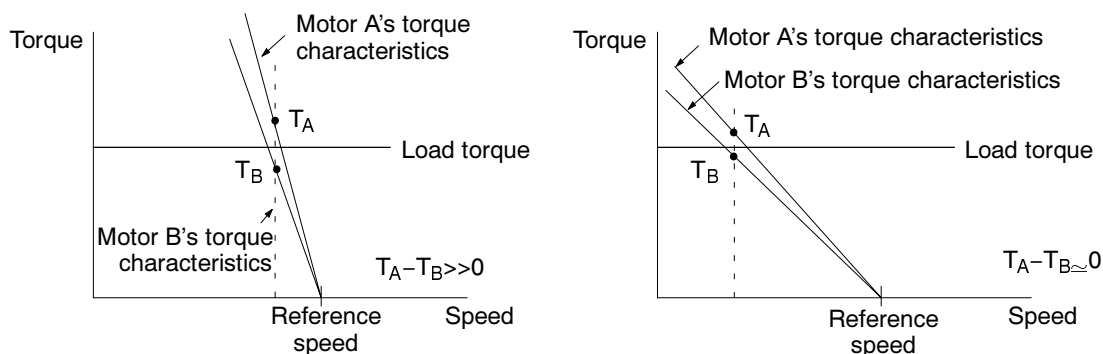

- Load balance when using a general-purpose motor
- Load balance when using a high-resistance motor

If droop control is used, a high-resistance motor's characteristics can be set for a general-purpose motor. Also, it is easy to make adjustments while watching the load balance because the amount of slip can be set arbitrarily.

Set the amount of slip in parameter b7-01 as the percentage of slip when the maximum frequency is input and the rated torque is generated. Droop control is disabled if b7-01 is set to 0.0.

Parameter b7-02 is used to adjust the responsiveness of droop control. Increase this setting if vibration or hunting occur.

| Parameter number | Display name     | Setting range | Units | Default setting | Valid access levels |             |                  |             |
|------------------|------------------|---------------|-------|-----------------|---------------------|-------------|------------------|-------------|
|                  |                  |               |       |                 | V/f Control         | V/f with PG | Open Loop Vector | Flux Vector |
| b7-01            | Droop gain       | 0.0 to 100.0  | %     | 0.0             | Not applicable.     |             |                  |             |
| b7-02            | Droop delay time | 0.00 to 1.00  | s     | 0.00            |                     |             |                  |             |

**Note** These parameters cannot be changed during operation.

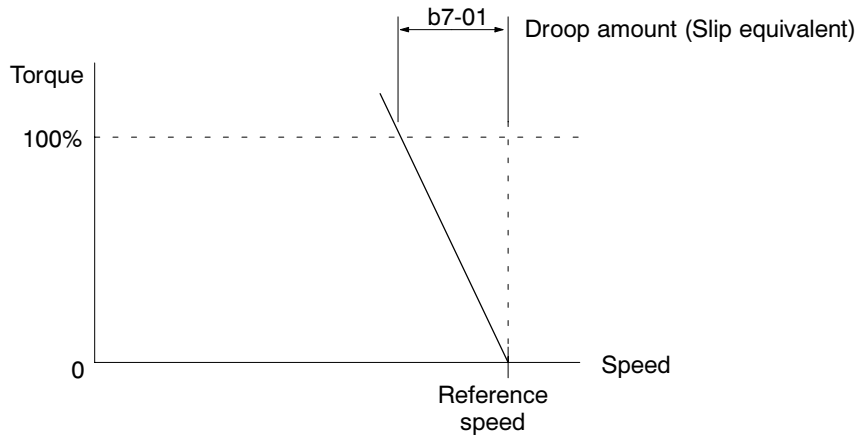

### 6-3-3 Zero-servo Function (Position-lock)

The zero-servo function is enabled when one of the multi-function inputs (H1-01 through H1-06) is set to 72 (Zero Servo Command). If the zero-servo command is ON when the frequency (speed) reference falls below the excitation level (b2-01), a position control loop is formed and the motor is stopped. (The motor will not rotate even if there is an offset in the analog command input.)

| Parameter number | Display name     | Setting range | Units  | Default setting | Valid access levels |             |                  |             |
|------------------|------------------|---------------|--------|-----------------|---------------------|-------------|------------------|-------------|
|                  |                  |               |        |                 | V/f Control         | V/f with PG | Open Loop Vector | Flux Vector |
| b9-01            | Zero Servo Gain  | 0 to 100      | ---    | 5               | Not applicable      |             |                  |             |
| b9-02            | Zero Servo Count | 0 to 16383    | Pulses | 10              | Advanced            |             |                  |             |

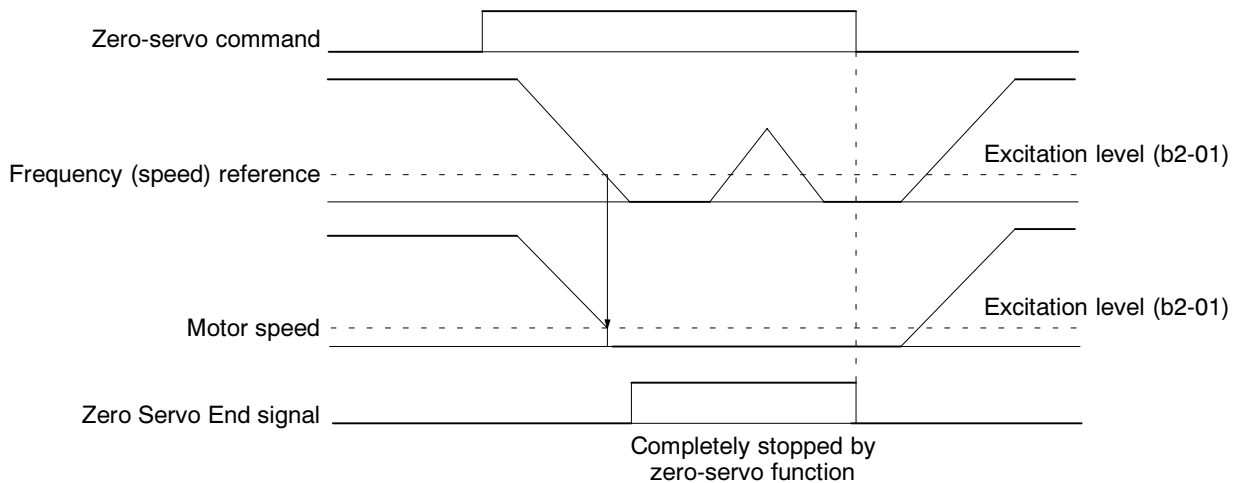

- Assign the servo-lock command (setting 72) to one of the multi-function inputs (H1-01 through H1-06).
- The zero-servo status is entered when the frequency (speed) reference falls below the zero-speed level (b2-01).
- Be sure to leave the run command input ON. If the run command is turned OFF, the output will be interrupted and the zero-servo function will become ineffective.

- Adjust the holding strength of the zero-servo position lock with parameter b9-01 (Zero Servo Gain). Increasing this setting increases the holding strength, although vibration will occur if the setting is too high. (Adjust the holding strength after adjusting the speed control (ASR) gain.)
- To output the zero-servo status externally, assign the Zero Servo End signal (setting 33) to one of the multi-function outputs (H2-01 through H2-03). The Zero Servo Count setting in b9-02 is enabled when one of the multi-function outputs has been set to 33.
- The “Zero Servo Count” specifies the allowed offset from the starting position, and the Zero Servo End signal remains ON as long as the position is within this range (starting position ± Zero Servo Count).
- Set the Zero Servo Count to four times the number of pulses from the PG (pulse generator or encoder), as shown in the following diagram. For example, when a 1,000 p/r encoder is being used, the number of pulses would be 4,000 p/r after multiplying by four.
- The Zero Servo End signal will go OFF when the zero-servo command is turned OFF.
- These parameters cannot be changed during operation.

Factor of 4: By counting the rising and falling edges of phase A and phase B, this method has four times the resolution of the PG.

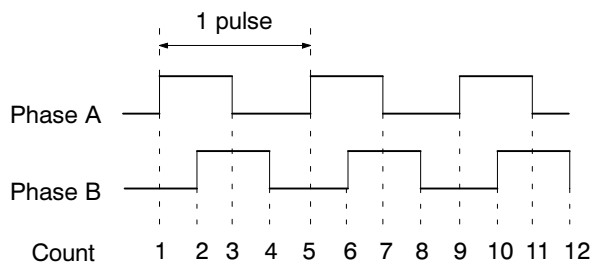

### 6-3-4 Torque Control

#### ■ Torque Control Function Settings

With flux vector control, the motor’s output torque can be controlled by a torque reference from an analog input. Set parameter d5-01 to “1” to select torque control. This parameter cannot be changed during operation.

| Parameter number | Display name     | Setting range | Units | Default setting | Valid access levels      |             |                  |             |
|------------------|------------------|---------------|-------|-----------------|--------------------------|-------------|------------------|-------------|
|                  |                  |               |       |                 | V/f Control              | V/f with PG | Open Loop Vector | Flux Vector |
| d5-01            | Torq Control Sel | 0 or 1        | ---   | 0               | Not applicable. Advanced |             |                  |             |

#### Settings

| Setting | Function  |
|---------|---|
| 0       | Speed control (controlled by C5-01 through C5-07) |
| 1       | Torque control                                    |

The following block diagram shows the operation of torque control.

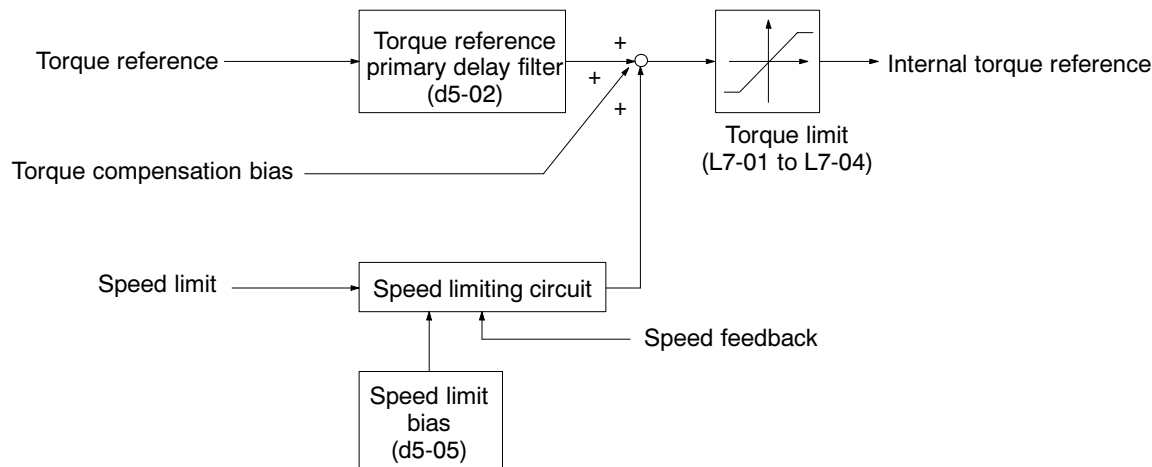

### ■ Torque Reference Settings

- Set multi-function analog input (terminal 16) or frequency reference current input (terminal 14) to torque reference. The torque reference value cannot be set with the Digital Operator.

| Parameter number | Display name    | Setting range | Units | Default setting | Valid access levels |             |                  |             |
|------------------|-----------------|---------------|-------|-----------------|---------------------|-------------|------------------|-------------|
|                  |                 |               |       |                 | V/f Control         | V/f with PG | Open Loop Vector | Flux Vector |
| H3-05            | Terminal 16 Sel | 0 to 1F       | ---   | 1F              | Basic or Advanced   |             |                  |             |
| H3-09            | Terminal 14 Sel | 1 to 1F       | ---   | 1F              | Advanced            |             |                  |             |

**Note** Set either one of these parameters to torque reference (setting 13). (These parameters cannot be changed during operation.)

- Next, set the signal level for the analog input terminal that was set to torque reference. These parameters cannot be changed during operation.

| Parameter number | Display name   | Setting range | Units | Default setting | Valid access levels |             |                  |             |
|------------------|----------------|---------------|-------|-----------------|---------------------|-------------|------------------|-------------|
|                  |                |               |       |                 | V/f Control         | V/f with PG | Open Loop Vector | Flux Vector |
| H3-04            | Term 16 Signal | 0 or 1        | ---   | 0               | Basic or Advanced   |             |                  |             |
| H3-08            | Term 14 Signal | 0 to 2        | ---   | 2               | Advanced            |             |                  |             |

### Signal Level Settings

| Setting | Function   |
|---------|--|
| 0       | 0- to +10-V input (When H3-08 is being set, be sure to disconnect jumper wire J1.) |
| 1       | 0- to ±10-V input (When H3-08 is being set, be sure to disconnect jumper wire J1.) |
| 2       | 4- to 20-mA input (H3-08 only)   |

**Note 1.** Set the proper signal level for the torque reference that you want to input.

**Note 2.** The direction of the torque that is output is determined by the sign (polarity) of the signal that was input. It is not determined by the direction of the run command (forward/reverse).

- +Voltage (or current): Forward torque reference (generally counter-clockwise; axis side)
- Voltage: Reverse torque reference (generally clockwise; axis side)

Since the polarity of the voltage input determines the direction, only forward torque references can be input when the “0 to +10 V” or “4 to 20 mA” signal level has been selected. If you want to input reverse torque references, be sure to select the “0 to ±10 V” signal level.

**Note 3.** When supplying a voltage input to the frequency reference current input (terminal 14), be sure to disconnect jumper wire J1 on the control board. If the jumper wire isn't disconnected, the input resistor will be destroyed.

**200-V Class, 0.4-kW Inverter Example**

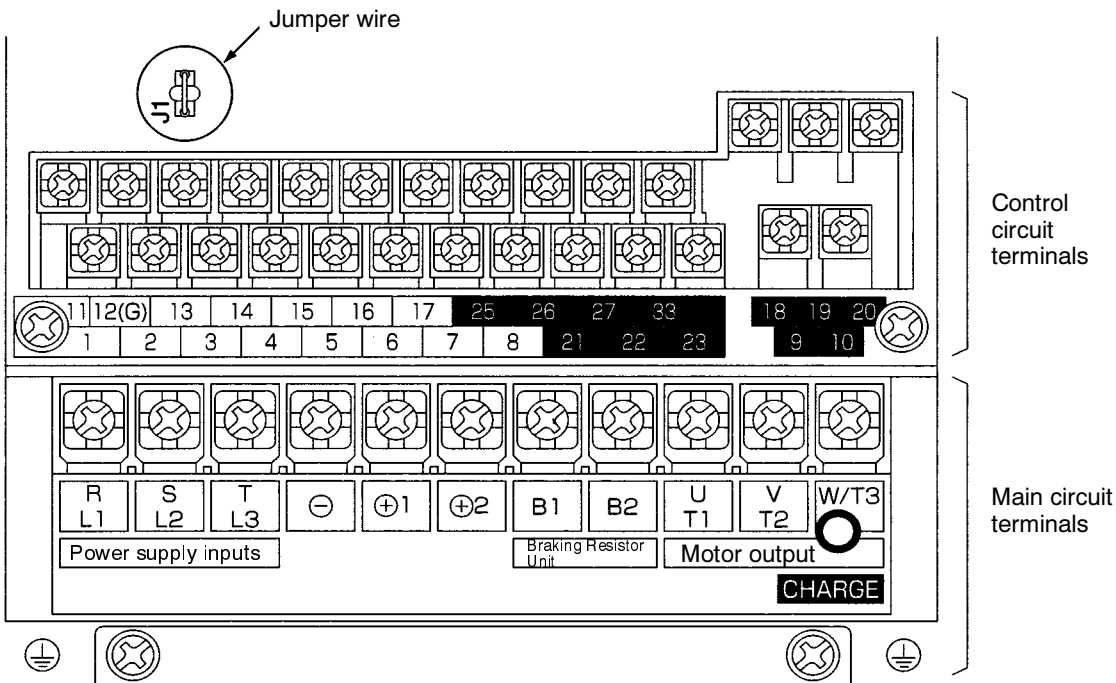

■ **Speed Limit Function Settings**

- This setting selects the speed limit function used when torque control is performed. With torque control, the motor sometimes rotates at high speed with no load or a light load. The speed limit function keeps the motor speed from exceeding the specified limit in these cases.
- If the speed limit is exceeded during torque control operation, a suppressing torque (proportional to the divergence from the speed limit) is added to the torque reference. (The suppressing torque is applied opposite to the motor rotation.)
- There are two ways to set the motor speed limit: a parameter setting or an analog input value.

● **Speed Limit Selection**

| Parameter number | Display name    | Setting range | Units | Default setting | Valid access levels |             |                  |             |
|------------------|-----------------|---------------|-------|-----------------|---------------------|-------------|------------------|-------------|
|                  |                 |               |       |                 | V/f Control         | V/f with PG | Open Loop Vector | Flux Vector |
| d5-03            | Speed Limit Sel | 1 or 2        | ---   | 1               | Not applicable.     |             |                  | Advanced    |

**Note** This parameter cannot be changed during operation.

**Settings**

| Setting | Function  |
|---------|---|
| 1       | The speed limit is set from one of the analog frequency reference terminals (13 or 14). |
| 2       | The speed limit is set to the value in parameter d5-04.                                 |

● **Speed Limit Selection Settings**

- Limit with Analog Input (d5-03 = 1)



- The speed limit value is set by the input voltage to frequency reference (voltage) terminal 13.
- When frequency reference (current) terminal 14 has been set to frequency reference by setting parameter H3-09 to 1F, this terminal is also used as an input terminal for the speed limit. In this case, the actual speed limit value is the sum of the voltage input value at terminal 13 and the current input value at terminal 14.
- The polarity of the speed limit signal and the direction of the run command determine the direction in which the speed is limited, as shown in the following table.

| Signal polarity | Run command      | Speed limit direction                      |
|-----------------|------------------|--|
| +Voltage input  | Forward rotation | Speed is limited in the forward direction. |
|                 | Reverse rotation | Speed is limited in the reverse direction. |
| -Voltage input  | Forward rotation | Speed is limited in the reverse direction. |
|                 | Reverse rotation | Speed is limited in the forward direction. |

- The speed limit value is zero for rotation opposite to the speed limit direction. For example, when a +voltage is being input and the forward rotation command is ON, the effective range of the torque control is from zero to the speed limit value in the forward direction (when parameter d5-05, the speed limit bias, is set to 0).

| Parameter number | Display name   | Setting range | Units | Default setting | Valid access levels |             |                  |             |
|------------------|----------------|---------------|-------|-----------------|---------------------|-------------|------------------|-------------|
|                  |                |               |       |                 | V/f Control         | V/f with PG | Open Loop Vector | Flux Vector |
| H3-01            | Term 13 Signal | 0 or 1        | ---   | 0               | Basic or Advanced   |             |                  |             |

**Note** Set the signal level to match the speed limit voltage being input. (This parameter cannot be changed during operation.)

- Limit with Parameter Setting (d5-03 = 2)

| Parameter number | Display name    | Setting range | Units | Default setting | Valid access levels |             |                  |             |
|------------------|-----------------|---------------|-------|-----------------|---------------------|-------------|------------------|-------------|
|                  |                 |               |       |                 | V/f Control         | V/f with PG | Open Loop Vector | Flux Vector |
| d5-04            | Speed Lmt Value | -120 to +120  | %     | 0               | Not applicable.     |             |                  | Advanced    |

**Note** This parameter cannot be changed during operation.

- Set the speed limit as a percentage of the maximum frequency. (The max. frequency is 100%.)
- The sign of the parameter setting and the direction of the run command determine the direction in which the speed is limited, as shown in the following table.

| Sign of d5-04 | Run command      | Speed limit direction                      |
|---------------|------------------|--|
| Setting +     | Forward rotation | Speed is limited in the forward direction. |
|               | Reverse rotation | Speed is limited in the reverse direction. |
| Setting -     | Forward rotation | Speed is limited in the reverse direction. |
|               | Reverse rotation | Speed is limited in the forward direction. |

- The speed limit value is zero for rotation opposite to the speed limit direction. For example, when a positive value is set in d5-04 and the forward rotation command is ON, the effective range of the torque control is from zero to the speed limit value in the forward direction (when parameter d5-05, the speed limit bias, is set to 0).

• Speed Limit Bias Setting

| Parameter number | Display name   | Setting range | Units | Default setting | Valid access levels |             |                  |             |
|------------------|----------------|---------------|-------|-----------------|---------------------|-------------|------------------|-------------|
|                  |                |               |       |                 | V/f Control         | V/f with PG | Open Loop Vector | Flux Vector |
| d5-05            | Speed Lmt Bias | 0 to 120      | %     | 10              | Not applicable.     |             |                  |             |

**Note** This parameter cannot be changed during operation.

- Set the speed limit bias as a percentage of the maximum frequency. (The max. frequency is 100%.)
- The speed limit bias can be used to add margins to the speed limit.
- When the speed limit bias is used, it is possible to set the same speed limit value in both the forward and reverse directions. For example, the following settings establish speed limits of 50% of the maximum frequency in both the forward and reverse directions.
  - Speed limit setting: Zero (with d5-04 as the speed limit: d5-03 = 2, d5-04 = 0)
  - Speed limit bias setting: 50% (d5-05 = 50)
- When a forward speed limit and a speed limit bias have been set, the speed range of the torque control is from the “–speed limit bias setting” to the “speed limit setting + speed limit bias setting.” In effect, the speed limit range is extended by the speed limit bias in both the forward and reverse directions.

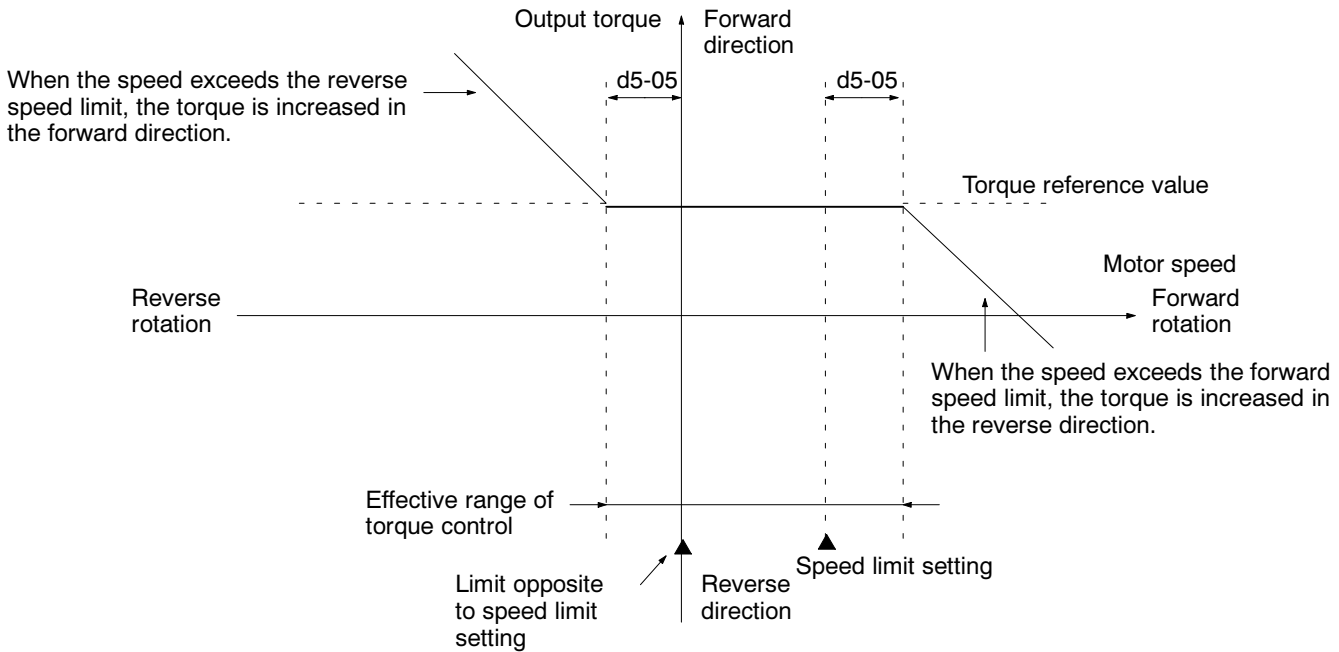

■ Torque Reference Adjustment

• Primary Delay Time Constant for Torque Reference Filter

- The time constant of the primary filter in the torque reference section can be adjusted.

- This parameter is used to eliminate noise in the torque reference signal and adjust the responsiveness to the host controller. This parameter cannot be changed during operation.

| Parameter number | Display name    | Setting range | Units | Default setting | Valid access levels      |             |                  |             |
|------------------|-----------------|---------------|-------|-----------------|--------------------------|-------------|------------------|-------------|
|                  |                 |               |       |                 | V/f Control              | V/f with PG | Open Loop Vector | Flux Vector |
| d5-02            | Torq Ref Filter | 0 to 1000     | ms    | 0               | Not applicable. Advanced |             |                  |             |

**Note 1.** Set the torque reference filter’s primary delay time constant in ms units.

**Note 2.** Increase the time constant setting if vibration occurs during torque control operation.

● **Setting the Torque Compensation Bias**

- Set multi-function analog input (terminal 16) or frequency reference current input (terminal 14) to torque compensation (setting 14).
- When the amount of torque loss at the load is input to one of these terminals, it is added to the torque reference to compensate for the loss.

| Parameter number | Display name    | Setting range | Units | Default setting | Valid access levels |             |                  |             |
|------------------|-----------------|---------------|-------|-----------------|---------------------|-------------|------------------|-------------|
|                  |                 |               |       |                 | V/f Control         | V/f with PG | Open Loop Vector | Flux Vector |
| H3-05            | Terminal 16 Sel | 0 to 1F       | ---   | 1F              | Basic or Advanced   |             |                  |             |
| H3-09            | Terminal 14 Sel | 1 to 1F       | ---   | 1F              | Advanced            |             |                  |             |

**Note 1.** Set torque compensation (setting 14) in the input terminal that wasn’t set to torque reference (setting 13).

**Note 2.** These parameters cannot be changed during operation.

- Set the signal level for the terminal. These parameters cannot be changed during operation.

| Parameter number | Display name   | Setting range | Units | Default setting | Valid access levels |             |                  |             |
|------------------|----------------|---------------|-------|-----------------|---------------------|-------------|------------------|-------------|
|                  |                |               |       |                 | V/f Control         | V/f with PG | Open Loop Vector | Flux Vector |
| H3-04            | Term 16 Signal | 0 or 1        | ---   | 0               | Basic or Advanced   |             |                  |             |
| H3-08            | Term 14 Signal | 0 to 2        | ---   | 2               | Advanced            |             |                  |             |

**Signal Level Settings**

| Setting | Function  |
|---------|---|
| 0       | 0 to +10 V input (When H3-08 is being set, be sure to disconnect jumper wire J1.) |
| 1       | 0 to ±10 V input (When H3-08 is being set, be sure to disconnect jumper wire J1.) |
| 2       | 4 to 20 mA input (H3-08 only)   |

**Note 1.** Set the proper signal level for the torque compensation bias that you want to input.

**Note 2.** The direction of the torque compensation bias is determined by the sign (polarity) of the signal that is input. It is not determined by the direction of the run command (forward/reverse).

+Voltage (or current): Forward torque compensation

(generally counter-clockwise; axis side)

–Voltage: Reverse torque compensation (generally clockwise; axis side)

Since the polarity of the voltage input determines the direction, only forward torque compensation can be input when the “0 to +10 V” or “4 to 20 mA” signal level has been selected. If you want to input reverse torque compensation, be sure to select the “0 to ±10 V” signal level.

**Note 3.** When supplying a voltage input to the frequency reference current input (terminal 14), be sure to disconnect jumper wire J1 on the control board. If the jumper wire isn't disconnected, the input resistor will be destroyed. Refer to page 6-18 for a diagram of the control board.

● **Adjusting the Gain/Bias of the Analog Inputs**

• Adjust the gain and bias for the frequency reference (voltage), frequency reference (current), and multi-function analog inputs according to the input specifications for each input. The following parameters can be changed during operation.

| Parameter number | Display name     | Setting range   | Units | Default setting | Valid access levels |             |                  |             |
|------------------|------------------|-----------------|-------|-----------------|---------------------|-------------|------------------|-------------|
|                  |                  |                 |       |                 | V/f Control         | V/f with PG | Open Loop Vector | Flux Vector |
| H3-02            | Terminal 13 Gain | 0.0 to 1,000.0  | %     | 100.0           | Basic or Advanced   |             |                  |             |
| H3-03            | Terminal 13 Bias | -100.0 to 100.0 | %     | 0.0             | Basic or Advanced   |             |                  |             |
| H3-06            | Terminal 16 Gain | 0.0 to 1,000.0  | %     | 100.0           | Basic or Advanced   |             |                  |             |
| H3-07            | Terminal 16 Bias | -100.0 to 100.0 | %     | 0.0             | Basic or Advanced   |             |                  |             |
| H3-10            | Terminal 14 Gain | 0.0 to 1,000.0  | %     | 100.0           | Advanced            |             |                  |             |
| H3-11            | Terminal 14 Bias | -100.0 to 100.0 | %     | 0.0             | Advanced            |             |                  |             |

**Note 1.** Adjust the gain so that the maximum signal level corresponds to the maximum frequency or the motor's rated torque, as follows.

- When the input terminal is used for frequency reference:  
A 10-V (20 mA) input indicates a frequency reference that is 100% of the max. frequency.
- When the input terminal is used for torque reference:  
A 10-V (20 mA) input indicates a torque reference that is 100% of the motor's rated torque.
- When the input terminal is used for torque compensation:  
A 10-V (20 mA) input indicates a torque compensation that is 100% of the motor's rated torque.

**Note 2.** Adjust the bias so that the minimum signal level corresponds to the maximum frequency or the motor's rated torque, as follows.

- When the input terminal is used for frequency reference:  
A 0-V (4 mA) input indicates a frequency reference that is 100% of the max. frequency.
- When the input terminal is used for torque reference:  
A 0-V (4 mA) input indicates a torque reference that is 100% of the motor's rated torque.

- When the input terminal is used for torque compensation:  
A 0-V (4 mA) input indicates a torque compensation that is 100% of the motor’s rated torque.

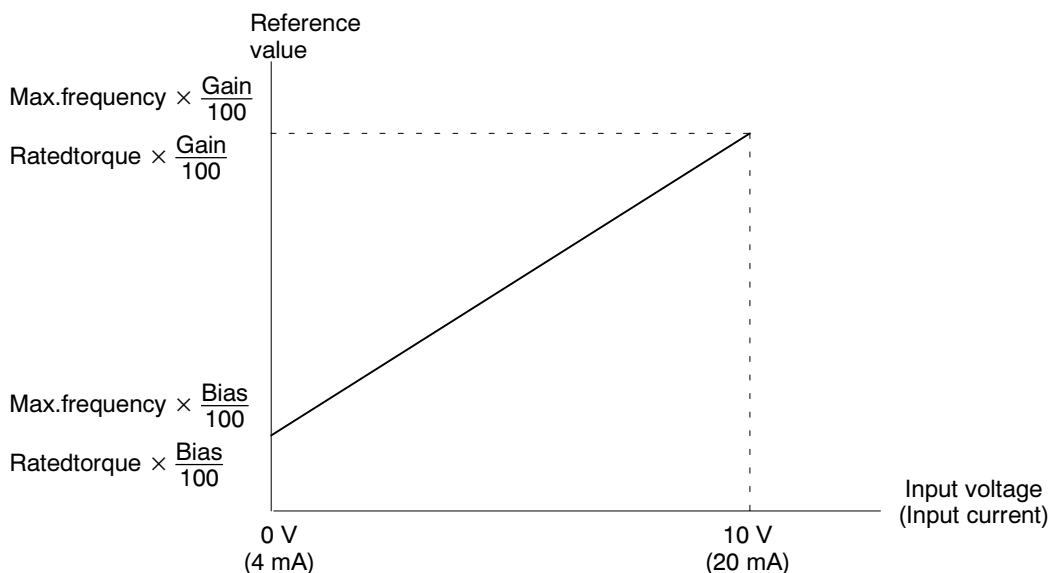

**Note** Use the current values shown in parentheses when current input has been selected.

### 6-3-5 Speed/Torque Control Switching Function

It is possible to switch between speed control and torque control when one of the multi-function inputs (H1-01 through H1-06) is set to 71 (Speed/Torque Control Change). Speed control is performed when the input is OFF and torque control is performed when the input is ON.

#### ■ Torque Control Function Settings

| Parameter number | Display name     | Setting range | Units | Default setting | Valid access levels |             |                  |             |
|------------------|------------------|---------------|-------|-----------------|---------------------|-------------|------------------|-------------|
|                  |                  |               |       |                 | V/f Control         | V/f with PG | Open Loop Vector | Flux Vector |
| d5-01            | Torq Control Sel | 0 or 1        | ---   | 0               | Not applicable.     |             |                  |             |
|                  |                  |               |       |                 |                     |             |                  | Advanced    |

**Note** This parameter cannot be changed during operation.

#### Settings

| Setting | Function  |
|---------|---|
| 0       | Speed control (controlled by C5-01 through C5-07) |
| 1       | Torque control                                    |

**Note** Set parameter d5-01 to 0 (speed control) when using the speed/torque control switching function.

#### ■ Setting the Speed/Torque Control Switching Timer

This setting specifies the delay (0 to 1,000 ms) between a change in the multi-function input (ON → OFF or OFF → ON) and the corresponding change in the control mode. The timer setting is effective only when 71 (Speed/Torque Control Change) has been set in one of the multi-function inputs (H1-01 through H1-06).

During the timer delay, the value of the 3 analog inputs will retain the values they had when the ON/OFF status of speed/torque control switching signal was changed. Use this delay to make any preparations for the change in the control mode.

| Parameter number | Display name  | Setting range | Units | Default setting | Valid access levels |             |                  |             |
|------------------|---------------|---------------|-------|-----------------|---------------------|-------------|------------------|-------------|
|                  |               |               |       |                 | V/f Control         | V/f with PG | Open Loop Vector | Flux Vector |
| d5-06            | Ref Hold Time | 0 to 1000     | ms    | 0               | Not applicable.     |             |                  |             |
|                  |               |               |       |                 |                     |             |                  | Advanced    |

### ■ Frequency Reference and Speed Limit

The frequency reference (during speed control) is set with b1-01 (Reference Source).

The speed limit (during torque control) is set with d5-03 (Speed Limit Selection).

It is possible to assign the frequency reference and speed limit functions to the same analog input terminal (13 or 14).

### ■ Torque Reference and Torque Limit

If the torque reference has been assigned to a multi-function analog input or the frequency reference (current) terminal, the input's function changes when the control mode is switched between torque control and speed control.

- During speed control: The analog input terminal is used as the torque limit input.
- During torque control: The analog input terminal is used as the torque reference input.

Either the absolute value of the torque limit input or the torque limit parameter setting (L7-01 through L7-04), whichever is smaller, will be used for the torque limit.

### ■ Stopping Method

When the run command is turned OFF during speed control, the motor is decelerated to a stop.

When the run command is turned OFF during torque control, the control mode is automatically switched to speed control and the motor is decelerated to a stop.

## 6-3-6 Torque Limit Function

---



---

With flux vector control, the torque limit can be applied at an arbitrary value because the torque output by the motor is calculated internally.

The torque limit function is useful when the load cannot sustain a torque above a certain level or regenerative torque above a certain level. The two ways to apply a torque limit are listed below. (The lower torque limit will be used if both of these methods are set.)

- 1) Setting a torque limit with the parameters
- 2) Limiting torque with the analog inputs

The precision of the torque limit is  $\pm 5\%$  at all frequencies.

---



---

### ■ Setting a Torque Limit with Parameters

Torque limits can be set separately for the 4 ways that torque can be applied: forward torque, reverse torque, forward regenerative torque, and reverse forward regenerative torque. These parameters cannot be changed during operation.

| Parameter number | Display name         | Setting range | Units | Default setting | Valid access levels |             |                   |             |
|------------------|----------------------|---------------|-------|-----------------|---------------------|-------------|-------------------|-------------|
|                  |                      |               |       |                 | V/f Control         | V/f with PG | Open Loop Vector  | Flux Vector |
| L7-01            | Torque Limit Fwd     | 0 to 300      | %     | 200             | Not applicable      |             | Basic or Advanced |             |
| L7-02            | Torque Limit Rev     |               |       |                 |                     |             |                   |             |
| L7-03            | Torque Limit Fwd Rgn |               |       |                 |                     |             |                   |             |
| L7-04            | Torque Limit Rev Rgn |               |       |                 |                     |             |                   |             |

The following diagram shows the relationship between each parameter and the output torque.

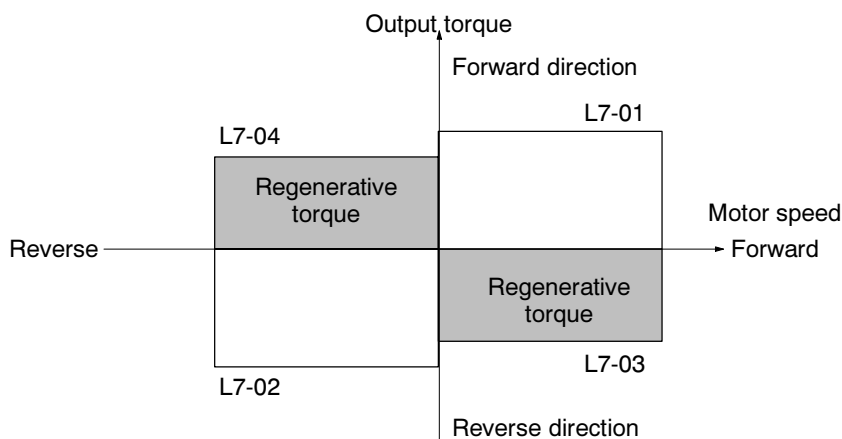

**Note** When the torque limit function is engaged the torque control has priority and motor speed control and compensation will be ignored, so the acceleration/deceleration times might be lengthened and motor speed might be reduced.

### ■ Limiting Torque with Analog Inputs

The following two analog inputs that can be used to limit torque.

- Multi-function analog input terminal 16
- Frequency reference (current) terminal 14

Use either or both of these inputs as needed with parameters H3-05 and H3-09. These parameters cannot be changed during operation.

| Parameter number | Display name    | Setting range | Units | Default setting | Valid access levels |             |                  |             |
|------------------|-----------------|---------------|-------|-----------------|---------------------|-------------|------------------|-------------|
|                  |                 |               |       |                 | V/f Control         | V/f with PG | Open Loop Vector | Flux Vector |
| H3-05            | Terminal 16 Sel | 0 to 1F       | ---   | 1F              | Basic or Advanced   |             |                  |             |
| H3-09            | Terminal 14 Sel | 1 to 1F       | ---   | 1F              | Advanced            |             |                  |             |

**Settings**

The following table shows only those settings related to the torque limit function.

| Setting | Name   |
|---------|--|
| 10      | Forward Torque Limit   |
| 11      | Reverse Torque Limit   |
| 12      | Regenerative Torque Limit  |
| 13      | Torque reference<br>(The input limits torque in both the forward and reverse directions during speed control.) |
| 15      | Speed Limit (Limits torque in both the forward and reverse directions.)  |

Set the analog input terminal’s signal level, gain, and bias to match the actual input signal. The factory default settings for the input terminal’s signal level are as follows:

- Terminal 16: 0 to +10 V (A 10-V input limits the torque to 100% of the motor’s rated torque.)
- Terminal 14: 4 to 20 mA (A 20-mA input limits the torque to 100% of the motor’s rated torque.)

The following diagram shows the relationship between the output torque and each torque limit.

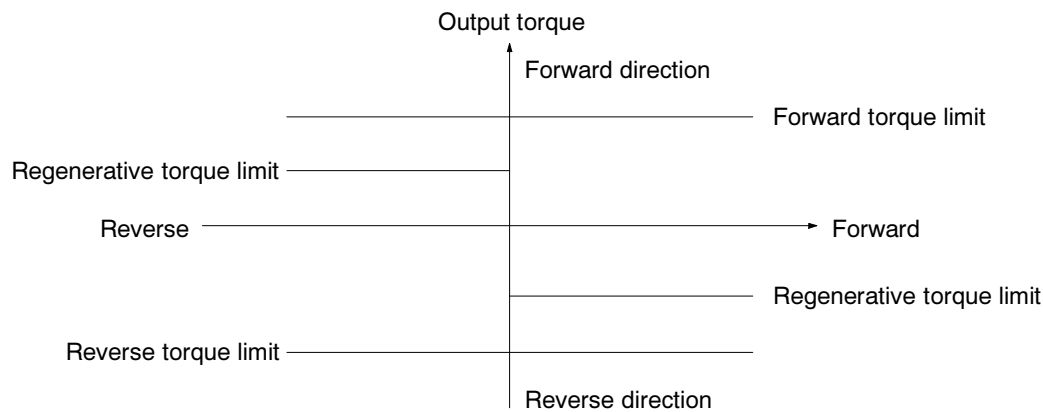

**Note 1.** When the forward torque limit has been set, the analog input signal acts as the limit value for torque generated in the forward direction. The torque limit input is effective when torque is generated in the forward direction even if the motor is operating in reverse (regenerative torque).

**Note 2.** The torque limit is 100% of the motor’s rated torque when the analog input is at its maximum value (10 V or 20 mA). To increase the torque limit above 100%, set the input terminal’s gain above 100%. For example, a gain of 150.0% would result in a torque limit of 150% of the motor’s rated torque with a 10-V or 20-mA analog input.



### 6-3-7 Setting/Adjusting Motor Constants

#### ■ Adjusting the V/f Pattern

Normally it isn't necessary to adjust the V/f pattern with flux vector control. Adjust the V/f pattern when you want to change the maximum frequency, maximum voltage, base frequency, or minimum output frequency settings.

| Parameter number | Display name   | Setting range  | Units | Default setting | Valid access levels*1 |             |                  |             |
|------------------|----------------|----------------|-------|-----------------|-----------------------|-------------|------------------|-------------|
|                  |                |                |       |                 | V/f Control           | V/f with PG | Open Loop Vector | Flux Vector |
| E1-04            | Max Frequency  | 50.0 to 400.0  | Hz    | 60.0            | Q                     | Q           | Q                | Q           |
| E1-05            | Max Voltage    | 0.0 to 255.0*2 | VAC   | 200.0*2         | Q                     | Q           | Q                | Q           |
| E1-06            | Base Frequency | 0.0 to 400.0   | Hz    | 60.0            | Q                     | Q           | Q                | Q           |
| E1-09            | Min Frequency  | 0.0 to 400.0   | Hz    | 0.0             | Q                     | Q           | Q                | A           |

**Note 1.** Q: Quick Start, Basic, or Advanced  
A: Advanced only

**Note 2.** These voltages are for the 200-V class; Double the voltage for 400-V class Inverters.

**Note 3.** The default setting for E1-09 depends on the control mode. The default settings shown in the table are for flux vector control.

**Note 4.** The three frequency settings must satisfy the following formula:

$$E1-04 (F_{MAX}) \geq E1-06 (F_A) > E1-09 (F_{MIN})$$

#### V/f Pattern

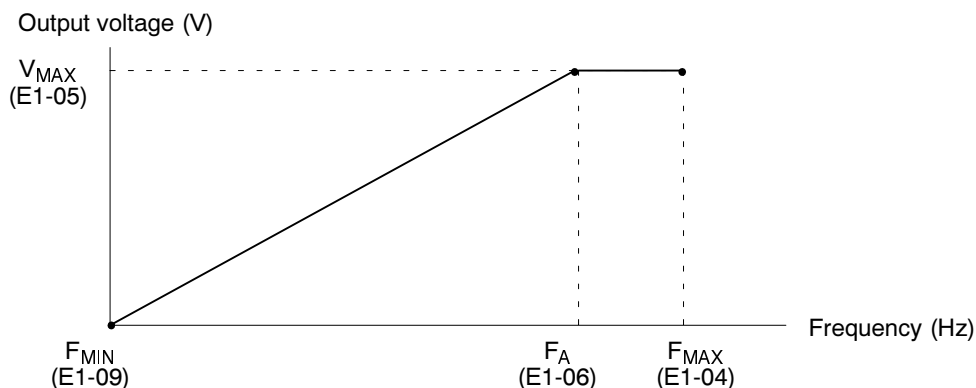

#### ● Units for V/f Pattern Settings

The units used for V/f pattern frequency settings can be changed when flux vector control has been selected. This parameter cannot be changed during operation.

| Parameter number | Display name  | Setting range | Units | Default setting | Valid access levels* |             |                  |             |
|------------------|---------------|---------------|-------|-----------------|----------------------|-------------|------------------|-------------|
|                  |               |               |       |                 | V/f Control          | V/f with PG | Open Loop Vector | Flux Vector |
| o1-04            | Display Units | 0 or 1        | ---   | 0               | Not applicable.      |             |                  |             |

**Note B:** Basic or Advanced

#### Display Unit Settings

| Setting | Function     |
|---------|--------------|
| 0       | Units: Hz    |
| 1       | Units: r/min |

**Note 1.** The setting units for parameters E1-04, E1-06, and E1-09 can be changed.

**Note 2.** This function is specific to flux vector control.

### ■ Setting Motor Constants

The motor constants (function E2) will all be set automatically when auto-tuning is performed, so it normally isn't necessary to set them manually. Set these parameters manually if auto-tuning can't be completed properly. These parameters cannot be changed during operation.

Set the rated current (A) shown on the motor's nameplate.

| Parameter number | Display name    | Setting range | Units | Default setting* | Valid access levels             |             |                  |             |
|------------------|-----------------|---------------|-------|------------------|---------------------------------|-------------|------------------|-------------|
|                  |                 |               |       |                  | V/f Control                     | V/f with PG | Open Loop Vector | Flux Vector |
| E2-01            | Motor Rated FLA | 0.32 to 6.40  | A     | 1.90             | Quick Start, Basic, or Advanced |             |                  |             |

**Note** The setting range is 10% to 200% of the Inverter's rated output current. The default setting depends upon the type of Inverter. (The table shows the default setting for 200-V class, 0.4-kW Inverters.)

Calculate the rated slip (E2-02) from the value shown on the motor's nameplate with the following equation and set this value.

$$\text{Rated slip} = \text{rated frequency (Hz)} - \text{rated speed (r/min)} \times \text{number of poles}/120$$

Set the no-load current (E2-03) at the rated voltage and rated frequency. Normally this value isn't shown on the motor's nameplate, so it might be necessary to contact the motor manufacturer.

| Parameter number | Display name     | Setting range  | Units | Default setting* | Valid access levels |             |                                 |             |
|------------------|------------------|----------------|-------|------------------|---------------------|-------------|---------------------------------|-------------|
|                  |                  |                |       |                  | V/f Control         | V/f with PG | Open Loop Vector                | Flux Vector |
| E2-02            | Motor Rated Slip | 0.00 to 20.00  | Hz    | 2.90             | Advanced            |             | Quick Start, Basic, or Advanced |             |
| E2-03            | No-Load Current  | 0.00 to 1500.0 | A     | 1.20             |                     |             |                                 |             |

**Note** The default setting depends upon the type of Inverter.  
(The table shows the default settings for 200-V class, 0.4-kW Inverters.)

Set the number of poles (E2-04) shown on the motor's nameplate.

| Parameter number | Display name    | Setting range | Units | Default setting | Valid access levels* |             |                  |             |
|------------------|-----------------|---------------|-------|-----------------|----------------------|-------------|------------------|-------------|
|                  |                 |               |       |                 | V/f Control          | V/f with PG | Open Loop Vector | Flux Vector |
| E2-04            | Number of Poles | 2 to 48       | ---   | 4               | ---                  | Q           | ---              | Q           |

**Note** Q: Quick Start, Basic, or Advanced  
---: Not applicable.

Set the motor's terminal resistance (phase to phase) in parameter E2-05. Normally this value isn't shown on the motor's nameplate, so it might be necessary to contact the motor manufacturer for the terminal resistance at the insulation class temperature. Use the following equation to calculate the resistance value from the terminal resistance at the insulation class temperature ( $T_{IL}$ ).

$$\text{Motor terminal resistance } (\Omega) = \text{Terminal resistance at } T_{IL} (\Omega) \times \frac{273^\circ\text{C} + (25^\circ\text{C} + T_{IL})}{273^\circ\text{C} + T_{IL}}$$

The insulation class temperatures ( $T_{IL}$ ) are as follows:

A-type = 105°C, B-type = 120°C, F-type = 155°C, and H-type = 180°C

| Parameter number | Display name    | Setting range   | Units    | Default setting | Valid access levels |             |                  |             |
|------------------|-----------------|-----------------|----------|-----------------|---------------------|-------------|------------------|-------------|
|                  |                 |                 |          |                 | V/f Control         | V/f with PG | Open Loop Vector | Flux Vector |
| E2-05            | Term Resistance | 0.000 to 65.000 | $\Omega$ | 9.842           | Advanced            |             |                  |             |

**Note** The default setting depends upon the type of Inverter.

(The table shows the default settings for 200-V class, 0.4-kW Inverters.)

Set the voltage drop (caused by the motor’s leakage inductance) as a percentage of the motor’s rated voltage in parameter E2-06. Normally this value isn’t shown on the motor’s nameplate, so it might be necessary to contact the motor manufacturer.

It is also acceptable to set the loss (caused by the motor’s leakage inductance) as a percentage.

| Parameter number | Display name    | Setting range | Units | Default setting | Valid access levels |             |                  |             |
|------------------|-----------------|---------------|-------|-----------------|---------------------|-------------|------------------|-------------|
|                  |                 |               |       |                 | V/f Control         | V/f with PG | Open Loop Vector | Flux Vector |
| E2-06            | Leak Inductance | 0.0 to 30.0   | %     | 18.2            | Not applicable.     |             | Advanced         |             |

**Note** The default setting depends upon the type of Inverter.

(The table shows the default settings for 200-V class, 0.4-kW Inverters.)

Parameters E2-07 and E2-08 are used in a frequency range even higher than the motor’s rated frequency. It isn’t necessary to set these parameters when operating below the motor’s rated frequency. Set the following values:

Motor core-saturation coefficient 1: Core-saturation coefficient when magnetic flux is 50%.

Motor core-saturation coefficient 2: Core-saturation coefficient when magnetic flux is 75%.

Normally these values aren’t shown on the motor’s nameplate, so it might be necessary to contact the motor manufacturer.

| Parameter number | Display name      | Setting range | Units | Default setting | Valid access levels |             |                  |             |
|------------------|-------------------|---------------|-------|-----------------|---------------------|-------------|------------------|-------------|
|                  |                   |               |       |                 | V/f Control         | V/f with PG | Open Loop Vector | Flux Vector |
| E2-07            | Saturation Comp 1 | 0.0 to 0.50   | ---   | 0.50            | Not applicable.     |             | Advanced         |             |
| E2-08            | Saturation Comp 2 | 0.00 to 0.75  | ---   | 0.75            |                     |             |                  |             |

**Note** It is possible to operate the motor with the default settings, but motor efficiency may decrease.

Parameter E2-09 is used to compensate for torque lost mechanically in the motor. Normally it isn’t necessary to change this setting, but it can be adjusted when there is a large torque loss to the motor’s bearings or to a fan or pump connected to the motor. This parameter cannot be changed during operation.

Set the mechanical loss as a percentage of the motor’s rated output power (W).

| Parameter number | Display name    | Setting range | Units | Default setting | Valid access levels |             |                  |             |
|------------------|-----------------|---------------|-------|-----------------|---------------------|-------------|------------------|-------------|
|                  |                 |               |       |                 | V/f Control         | V/f with PG | Open Loop Vector | Flux Vector |
| E2-09            | Mechanical Loss | 0.0 to 10.0   | %     | 0.0             | Not applicable.     |             |                  | Advanced    |

### ■ Setting the Slip Compensation Gain

With flux vector control, parameter C3-01 sets the motor’s temperature compensation gain. Adjust this setting when a torque limit or torque control is being used and the output torque varies with the ambient temperature. (There is no change to the compensation during speed control operation.)

Normally it isn't necessary to change this setting. If the motor's internal constants change at higher temperatures and the amount of slip increases, this parameter can be set to adjust the amount of slip according to an internally calculated temperature rise. This parameter cannot be changed during operation.

| Parameter number | Display name   | Setting range | Units  | Default setting | Valid access levels* |             |                  |             |
|------------------|----------------|---------------|--------|-----------------|----------------------|-------------|------------------|-------------|
|                  |                |               |        |                 | V/f Control          | V/f with PG | Open Loop Vector | Flux Vector |
| C3-01            | Slip Come Gain | 0.0 to 2.5    | Factor | 1.0             | B                    | ---         | B                |             |

**Note 1.** B: Basic or Advanced  
 ---: Not applicable.

**Note 2.** Adjust the setting if the output torque varies with the ambient temperature when a torque control or torque limit is being used. The compensation amount increases as the set value is increased. This adjustment is not required during speed control operation.

## 6-4 V/f Control With PG Feedback

This section summarizes the functions that can be used with V/f control with PG feedback, and provides detailed explanations of the functions that are specific to V/f control with PG feedback.

### 6-4-1 Summary of V/f Control With PG Feedback Functions

An “OK” in the control mode column indicates that the parameter can be changed in that control mode.

The functions specific to V/f control with PG feedback are marked with a “★” and described in more detail later in this section.

| Group       | Function |                  |  | Control mode |          |                  |             |
|-------------|----------|------------------|--|--------------|----------|------------------|-------------|
|             |          |                  |  | V/f          | V/f w/PG | Open-loop Vector | Flux Vector |
| Application | b1       | Sequence         | Settings such as the reference input method                                    | OK           | OK       | OK               | OK          |
|             | b2       | DC Braking       | DC braking function settings   | OK           | OK       | OK               | OK          |
|             | b3       | Speed Search     | Speed search function settings   | OK           | OK       | OK               | OK          |
|             | b4       | Delay Timers     | Timer function settings  | OK           | OK       | OK               | OK          |
|             | b5       | PID Control      | PID control settings   | OK           | OK       | OK               | OK          |
|             | b6       | Reference Hold   | Accel/deceleration time dwell function settings                                | OK           | OK       | OK               | OK          |
|             | b7       | Droop Control    | Not used. (Can't be set.)  | ---          | ---      | ---              | OK          |
|             | b8       | Energy Saving    | ★ Multi-function input: Sets energy-saving control by energy saving reference. | OK           | OK       | ---              | ---         |
|             | b9       | Zero Servo       | Not used. (Can't be set.)  | ---          | ---      | ---              | OK          |
| Tuning      | C1       | Accel/Decel      | Acceleration/deceleration time settings  | OK           | OK       | OK               | OK          |
|             | C2       | S-Curve Acc/Dec  | S-curve characteristics for accel/decel times                                  | OK           | OK       | OK               | OK          |
|             | C3       | Motor-Slip Comp  | Slip compensation function settings  | OK           | OK       | OK               | OK          |
|             | C4       | Torque Comp      | Torque compensation function settings  | OK           | OK       | OK               | ---         |
|             | C5       | ASR Tuning       | Speed control adjustment   | ---          | OK       | ---              | OK          |
|             | C6       | Carrier Freq     | Carrier frequency settings   | OK           | OK       | OK               | OK          |
|             | C7       | Hunting Prev     | ★ Hunting prevention settings  | OK           | OK       | ---              | ---         |
|             | C8       | Factory Tuning   | Not used. (Can't be set.)  | ---          | ---      | OK               | ---         |
| Reference   | d1       | Preset Reference | Frequency reference settings (when using Operator)                             | OK           | OK       | OK               | OK          |
|             | d2       | Reference Limits | Frequency upper and lower limit settings                                       | OK           | OK       | OK               | OK          |
|             | d3       | Jump Frequencies | Prohibited frequency settings  | OK           | OK       | OK               | OK          |
|             | d4       | Sequence         | Up/Down, Accel/Decel stop hold frequency setting                               | OK           | OK       | OK               | OK          |
|             | d5       | Torque Control   | Not used. (Can't be set.)  | ---          | ---      | ---              | OK          |
| Motor       | E1       | V/f Pattern      | ★ Motor constant settings (Motor constants are set manually.)                  | OK           | OK       | OK               | OK          |
|             | E2       | Motor Setup      |  | OK           | OK       | OK               | OK          |
| Options     | F1       | PG Option Setup  | Parameter settings for a PG Speed Control Card                                 | ---          | OK       | ---              | OK          |
|             | F2       | AI-14 Setup      | Parameter settings for an Analog Command Card                                  | OK           | OK       | OK               | OK          |
|             | F3       | DI-08, 16 Setup  | Parameter settings for a Digital Command Card                                  | OK           | OK       | OK               | OK          |
|             | F4       | AO-08, 12 Setup  | Parameter settings for an Analog Monitor Card                                  | OK           | OK       | OK               | OK          |
|             | F5       | Not used         | (Do not change these settings.)  | ---          | ---      | ---              | ---         |
|             | F6       | Not used         |  |              |          |                  |             |
|             | F7       | PO-36F Setup     | Parameter settings for a Pulse Monitor Card                                    | OK           | OK       | OK               | OK          |

| Group      | Function |                  |   | Control mode |          |                  |             |
|------------|----------|------------------|---|--------------|----------|------------------|-------------|
|            |          |                  |   | V/f          | V/f w/PG | Open-loop Vector | Flux Vector |
| Terminal   | H1       | Digital Inputs   | Function selection for multi-function inputs                    | OK           | OK       | OK               | OK          |
|            | H2       | Digital Outputs  | Function selection for multi-function outputs                   | OK           | OK       | OK               | OK          |
|            | H3       | Analog Inputs    | Adjustment/function selection for external analog inputs        | OK           | OK       | OK               | OK          |
|            | H4       | Analog Outputs   | Adjustment/function selection for multi-function analog outputs | OK           | OK       | OK               | OK          |
|            | H5       | Not used         | (Do not change these settings.)                                 | ---          | ---      | ---              | ---         |
| Protection | L1       | Motor Overload   | Sets electrical/thermal functions that protect the motor.       | OK           | OK       | OK               | OK          |
|            | L2       | PwrLoss Ridethru | Selects the power-loss processing method.                       | OK           | OK       | OK               | OK          |
|            | L3       | Stall Prevention | Accel/Decel stall prevention settings and selection             | OK           | OK       | OK               | OK          |
|            | L4       | Ref Detection    | Frequency detection settings and selection                      | OK           | OK       | OK               | OK          |
|            | L5       | Fault Restart    | Fault restart function settings                                 | OK           | OK       | OK               | OK          |
|            | L6       | Torque Detection | Sets overtorque detection functions 1 and 2                     | OK           | OK       | OK               | OK          |
|            | L7       | Torque Limit     | Not used. (Can't be set.)                                       | ---          | ---      | OK               | OK          |
|            | L8       | Hdwe Protection  | Hardware overheating and phase loss protection settings         | OK           | OK       | OK               | OK          |
| Operator   | o1       | Monitor Select   | Selects the Operator's display and setting methods.             | OK           | OK       | OK               | OK          |
|            | o2       | Key Selections   | Operator's key function selection and other parameters          | OK           | OK       | OK               | OK          |

### 6-4-2 Energy-saving Control Function

The energy-saving control function is enabled when the energy-saving command (setting 63) has been set in a multi-function input (H1-01 through H1-06). Inputting the energy-saving command while there is a light load causes the Inverter's output voltage to be reduced and saves energy. Turn OFF the energy-saving command when a normal load is added.

Parameter b8-01 determines the Inverter's output voltage when the energy-saving command is input. Set this value as a percentage of the V/f pattern's voltage. Parameter L2-04 (the voltage recovery time) determines the rate at which the output voltage is changed when the energy-saving command is turned ON or OFF.

Parameter b8-02 determines the lower limit frequency for the energy-saving function. The energy-saving command is enabled only when the frequency reference is above this lower limit and the motor speed is within the "speed agree" range.

Parameters b8-01 and b8-02 cannot be changed during operation.

| Parameter number | Display name     | Setting range | Units | Default setting | Valid access levels |             |                  |             |
|------------------|------------------|---------------|-------|-----------------|---------------------|-------------|------------------|-------------|
|                  |                  |               |       |                 | V/f Control         | V/f with PG | Open Loop Vector | Flux Vector |
| b8-01            | Energy Save Gain | 0 to 100      | %     | 80              | Advanced            |             | Not applicable.  |             |
| b8-02            | Energy Save Freq | 0.0 to 400.0  | Hz    | 0.0             |                     |             |                  |             |

Timing Chart

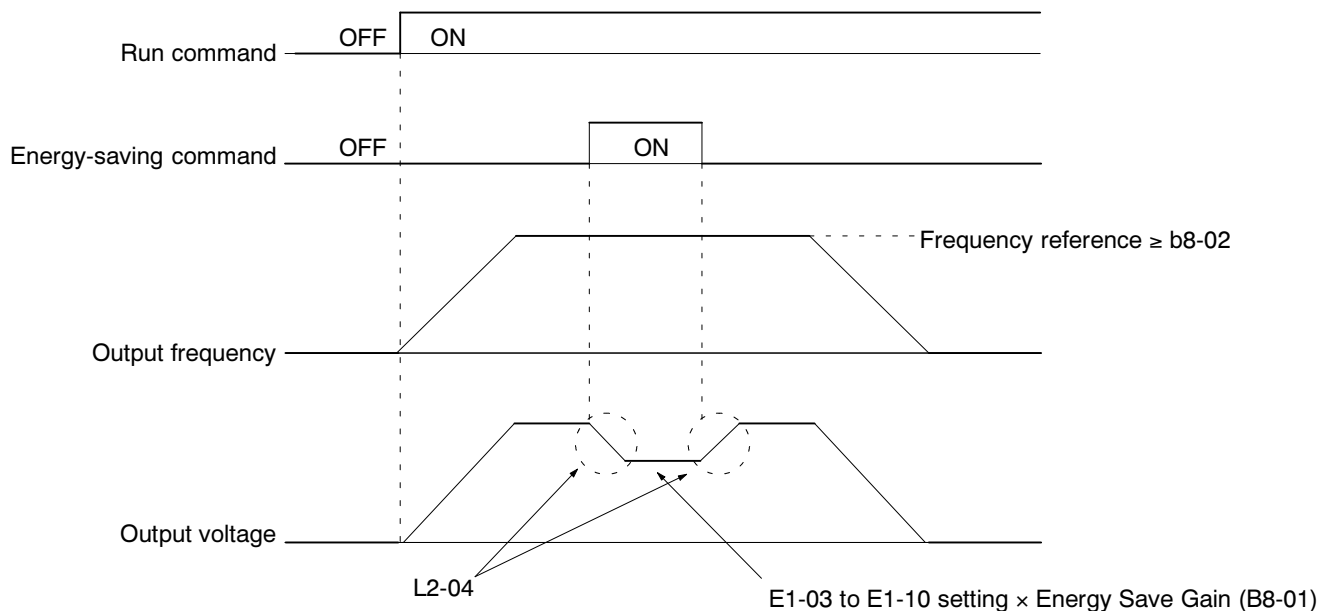

6-4-3 Hunting-prevention Function

The hunting-prevention function suppresses hunting when the motor is operating with a light load. This function is valid with V/f control and V/f with PG control. Parameters C7-01 and C7-02 cannot be changed during operation.

| Parameter number | Display name     | Setting range | Units | Default setting | Valid access levels |             |                  |             |
|------------------|------------------|---------------|-------|-----------------|---------------------|-------------|------------------|-------------|
|                  |                  |               |       |                 | V/f Control         | V/f with PG | Open Loop Vector | Flux Vector |
| C7-01            | Hunt Prev Select | 0, 1          | ---   | 1               | Advanced            |             | Not applicable.  |             |

| Setting | Function                                  |
|---------|---|
| 0       | Disables the hunting-prevention function. |
| 1       | Enables the hunting-prevention function.  |

| Parameter number | Display name   | Setting range | Units          | Default setting | Valid access levels |             |                  |             |
|------------------|----------------|---------------|----------------|-----------------|---------------------|-------------|------------------|-------------|
|                  |                |               |                |                 | V/f Control         | V/f with PG | Open Loop Vector | Flux Vector |
| C7-02            | Hunt Prev Gain | 0.0 to 2.50   | Multi-<br>ples | 1.00            | Advanced            |             | Not applicable.  |             |

Normally it isn't necessary to change these parameters. Adjust these parameters as follows if hunting occurs with a light load.

- Increase the setting in C7-02 if vibration occurs when operating with a light load. (If the setting is increased too much, the current can fall to the point where stalling occurs.)
- Decrease the setting in C7-02 if stalling occurs.
- Disable the hunting-prevention function (C7-01 = 0) if high responsiveness is more important than suppressing vibration.

### 6-4-4 Setting Motor Constants

The motor constants other than the V/f pattern parameters are described below:

Calculate the rated slip (E2-02) from the value shown on the motor’s nameplate with the following equation and set this value.

$$\text{Rated slip} = \text{rated frequency (Hz)} - \text{rated speed (r/min)} \times \text{number of poles}/120$$

Set the no-load current (E2-03) at the rated voltage and rated frequency. Normally this value isn’t shown on the motor’s nameplate, so it might be necessary to contact the motor manufacturer.

| Parameter number | Display name     | Setting range  | Units | Default setting* | Valid access levels |             |                                 |             |
|------------------|------------------|----------------|-------|------------------|---------------------|-------------|---------------------------------|-------------|
|                  |                  |                |       |                  | V/f Control         | V/f with PG | Open Loop Vector                | Flux Vector |
| E2-02            | Motor Rated Slip | 0.00 to 20.00  | Hz    | 2.90             | Advanced            |             | Quick Start, Basic, or Advanced |             |
| E2-03            | No-Load Current  | 0.00 to 1500.0 | A     | 1.20             |                     |             |                                 |             |

**Note 1.** The default setting depends upon the type of Inverter.  
(The table shows the default settings for 200-V class, 0.4-kW Inverters.)

**Note 2.** These settings are used as reference values for the motor slip compensation function.

Set the motor’s terminal resistance (phase to phase) in parameter E2-05. Normally this value isn’t shown on the motor’s nameplate, so it might be necessary to contact the motor manufacturer.

| Parameter number | Display name    | Setting range   | Units | Default setting | Valid access levels |             |                  |             |
|------------------|-----------------|-----------------|-------|-----------------|---------------------|-------------|------------------|-------------|
|                  |                 |                 |       |                 | V/f Control         | V/f with PG | Open Loop Vector | Flux Vector |
| E2-05            | Term Resistance | 0.000 to 65.000 | Ω     | 9.842           | Advanced            |             |                  |             |

**Note 1.** The default setting depends upon the type of Inverter.  
(The table shows the default settings for 200-V class, 0.4-kW Inverters.)

**Note 2.** This setting is used as a reference value for the torque compensation function.



## 6-5 Common Functions

This section summarizes the functions that can be used in common among the various modes, and provides detailed explanations of their operations.

### 6-5-1 Summary of Common Control Functions

An “OK” in the control mode column indicates that the parameter can be changed in that control mode. The functions that can be used in common are marked with a “★” and described in more detail later in this section.

| Group       | Function |                  | Comments   | Control mode |          |                  |             |
|-------------|----------|------------------|--|--------------|----------|------------------|-------------|
|             |          |                  |  | V/f          | V/f w/PG | Open-loop Vector | Flux Vector |
| Application | b1       | Sequence         | Settings such as the reference input method                                  | OK           | OK       | OK               | OK          |
|             | b2       | DC Braking       | ★ DC braking function settings   | OK           | OK       | OK               | OK          |
|             | b3       | Speed Search     | ★ Speed search function settings   | OK           | OK       | OK               | OK          |
|             | b4       | Delay Timers     | ★ Timer function settings  | OK           | OK       | OK               | OK          |
|             | b5       | PID Control      | ★ PID control settings   | OK           | OK       | OK               | OK          |
|             | b6       | Reference Hold   | ★ Accel/deceleration time dwell function settings                            | OK           | OK       | OK               | OK          |
|             | b7       | Droop Control    | Droop control settings   | ---          | ---      | ---              | OK          |
|             | b8       | Energy Saving    | Multi-function input: Sets energy-saving control by energy saving reference. | OK           | OK       | ---              | ---         |
|             | b9       | Zero Servo       | Zero servo settings  | ---          | ---      | ---              | OK          |
| Tuning      | C1       | Accel/Decel      | Acceleration/deceleration time settings                                      | OK           | OK       | OK               | OK          |
|             | C2       | S-Curve Acc/Dec  | ★ S-curve characteristics for accel/decel times                              | OK           | OK       | OK               | OK          |
|             | C3       | Motor-Slip Comp  | ★ Slip compensation function settings  | OK           | OK       | OK               | OK          |
|             | C4       | Torque Comp      | ★ Torque compensation function settings                                      | OK           | OK       | OK               | ---         |
|             | C5       | ASR Tuning       | Speed control tuning   | ---          | OK       | ---              | OK          |
|             | C6       | Carrier Freq     | ★ Carrier frequency settings   | OK           | OK       | OK               | OK          |
|             | C7       | Hunting Prev     | Hunting prevention settings  | OK           | OK       | ---              | ---         |
|             | C8       | Factory Tuning   | Adjustment for open-loop vector control                                      | ---          | ---      | OK               | ---         |
| Reference   | d1       | Preset Reference | Frequency reference settings (when using Operator)                           | OK           | OK       | OK               | OK          |
|             | d2       | Reference Limits | ★ Frequency upper and lower limit settings                                   | OK           | OK       | OK               | OK          |
|             | d3       | Jump Frequencies | ★ Prohibited frequency settings  | OK           | OK       | OK               | OK          |
|             | d4       | Sequence         | ★ Up/Down, Accel/Decel stop hold frequency setting                           | OK           | OK       | OK               | OK          |
|             | d5       | Torque Control   | Torque control settings and tuning   | ---          | ---      | ---              | OK          |
| Motor       | E1       | V/f Pattern      | Motor constant settings  | OK           | OK       | OK               | OK          |
|             | E2       | Motor Setup      |  | OK           | OK       | OK               | OK          |
| Options     | F1       | PG Option Setup  | Parameter settings for a PG Speed Control Card                               | ---          | OK       | ---              | OK          |
|             | F2       | AI-14 Setup      | ★ Parameter settings for an Analog Command Card                              | OK           | OK       | OK               | OK          |
|             | F3       | DI-08, 16 Setup  | ★ Parameter settings for a Digital Command Card                              | OK           | OK       | OK               | OK          |
|             | F4       | AO-08, 12 Setup  | ★ Parameter settings for an Analog Monitor Card                              | OK           | OK       | OK               | OK          |
|             | F5       | DO-02 Setup      | Not Used. (Do not change these settings.)                                    | ---          | ---      | ---              | ---         |
|             | F6       | DO-08 Setup      |  |              |          |                  |             |
|             | F7       | PO-36F Setup     | ★ Parameter settings for a Pulse Monitor Card                                | OK           | OK       | OK               | OK          |
| Terminal    | H1       | Digital Inputs   | ★ Function selection for multi-function inputs                               | OK           | OK       | OK               | OK          |
|             | H2       | Digital Outputs  | ★ Function selection for multi-function outputs                              | OK           | OK       | OK               | OK          |
|             | H3       | Analog Inputs    | ★ Adjustment/function selection for external analog inputs                   | OK           | OK       | OK               | OK          |
|             | H4       | Analog Outputs   | ★ Adjustment/function selection for multi-function analog outputs            | OK           | OK       | OK               | OK          |
|             | H5       | Serial Com Setup | Not Used. (Do not change this setting.)                                      | ---          | ---      | ---              | ---         |

| Group      | Function |                  | Comments  | Control mode |          |                  |             |
|------------|----------|------------------|---|--------------|----------|------------------|-------------|
|            |          |                  |   | V/f          | V/f w/PG | Open-loop Vector | Flux Vector |
| Protection | L1       | Motor Overload   | ★ Sets electrical/thermal functions that protect the motor. | OK           | OK       | OK               | OK          |
|            | L2       | PwrLoss Ridethru | ★ Selects the power-loss processing method.                 | OK           | OK       | OK               | OK          |
|            | L3       | Stall Prevention | ★ Accel/Decel stall prevention settings and selection       | OK           | OK       | OK               | OK          |
|            | L4       | Ref Detection    | ★ Frequency detection settings and selection                | OK           | OK       | OK               | OK          |
|            | L5       | Fault Restart    | ★ Fault restart function settings                           | OK           | OK       | OK               | OK          |
|            | L6       | Torque Detection | ★ Sets overtorque detection functions 1 and 2               | OK           | OK       | OK               | OK          |
|            | L7       | Torque Limit     | Torque limit settings                                       | ---          | ---      | OK               | OK          |
|            | L8       | Hdwe Protection  | ★ Hardware overheating and phase loss protection settings   | OK           | OK       | OK               | OK          |
| Operator   | o1       | Monitor Select   | ★ Selects the Operator's display and setting methods.       | OK           | OK       | OK               | OK          |
|            | o2       | Key Selections   | ★ Operator's key function selection and other parameters    | OK           | OK       | OK               | OK          |

## 6-5-2 Application Parameters (b)

### ■ Setting DC Injection Braking (b2)

The DC injection braking function decelerates by applying a DC magnetic field to the motor.

#### DC injection braking time at start:

This is effective for temporarily stopping and then restarting, without regenerative processing, a motor coasting by inertia.

#### DC injection braking time at stop:

When there is a large load, this is used to prevent coasting by inertia when the motor is not completely stopped by normal deceleration. The stopping time can be shortened by lengthening the DC injection braking time or increasing the DC injection braking current.

| Parameter number | Display name      | Setting range | Units | Default setting | Valid access levels |             |                  |             |
|------------------|-------------------|---------------|-------|-----------------|---------------------|-------------|------------------|-------------|
|                  |                   |               |       |                 | V/f Control         | V/f with PG | Open Loop Vector | Flux Vector |
| b2-01            | DC Inj Start Freq | 0.0 to 10.0   | Hz    | 0.5             | Basic or Advanced   |             |                  |             |
| b2-02            | DC Inj Current    | 0 to 100      | %     | 50              | Basic or Advanced   |             |                  | ---         |
| b2-03            | DC Inj Time@Start | 0.0 to 10.00  | Sec   | 0.00            | Basic or Advanced   |             |                  |             |
| b2-04            | DC Inj Time@Stop  | 0.0 to 10.00  | Sec   | 0.50            | Basic or Advanced   |             |                  |             |

These parameters cannot be changed during operation.

- For the excitation level (b2-01), set the frequency for beginning DC injection braking at the time of deceleration. If the excitation level is lower than the minimum output frequency (E1-09), the DC injection braking will begin from the minimum output frequency.

**Note 1.** In flux vector control mode, DC injection braking becomes the initial excitation starting frequency at the time of deceleration. In that case, braking starts from the excitation level regardless of the minimum output frequency setting.

**Note 2.** The excitation level is also used as the operating frequency for the zero servo function (for flux vector control only).

- For the DC injection braking current (b2-02), set the value for the current that is output at the time of DC injection braking. DC injection braking current is set as a percentage of Inverter rated output current, with the Inverter rated output current taken as 100%. If the DC injection braking time (parameters b2-03 and b2-04) is longer than one second, set the DC injection braking current to 50% or less.
- For the DC injection braking time at start (b2-03), set the DC injection braking operating time for when the motor is started.
- For the DC injection braking time at stop (b2-04), set the DC injection braking operating time for when the motor is stopped.

**DC Injection (Initial Excitation) Timing Chart**

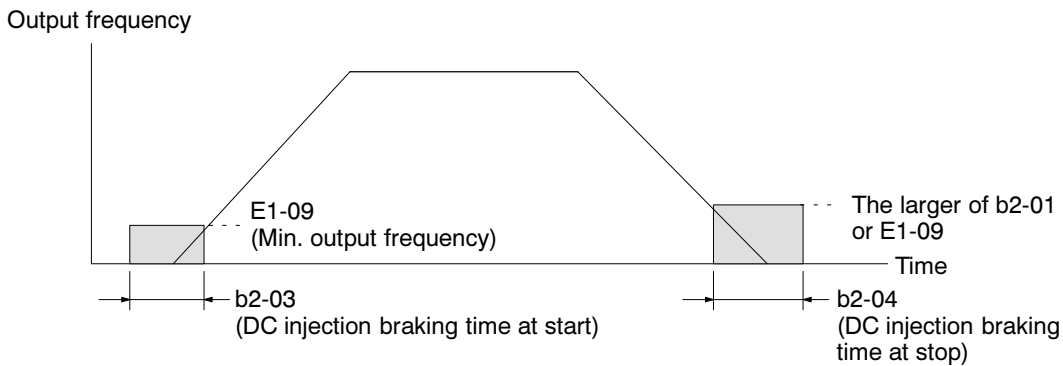

■ **Setting Speed Search (b3)**

The speed search function finds the speed of a coasting motor and starts up smoothly from that speed. It is effective in situations such as switching from a commercial power supply

| Parameter number | Display name      | Setting range | Units | Default setting | Valid access levels |             |                  |             |
|------------------|-------------------|---------------|-------|-----------------|---------------------|-------------|------------------|-------------|
|                  |                   |               |       |                 | V/f Control         | V/f with PG | Open Loop Vector | Flux Vector |
| b3-01            | Spd Srch at Start | 0, 1          | ---   | 0 (See note.)   | Advanced            |             |                  |             |

This parameter cannot be changed during operation.

**Note** When the control mode is switched, the factory default setting changes as follows:

V/f control: 0; V/f with PG: 1; open-loop vector 0; flux vector: 1

**Explanation of Settings**

| Set value | Contents  |
|-----------|---|
| 0         | Speed search disabled: Motor starts from minimum output frequency.  |
| 1         | Speed search enabled: Speed search is performed from maximum output frequency and motor is started. (In control modes with PG, i.e., V/f with PG and flux vector, motor starts from the motor speed.) |

Set “1” to use the speed search function. To use speed search freely in control modes without PG, i.e., V/f control and open-loop vector control, set the multi-function contact input selection (H1-01 to H1-06) to 61 or 62 (external search command).

| Parameter number | Display name      | Setting range | Units | Default setting | Valid access levels |             |                  |             |
|------------------|-------------------|---------------|-------|-----------------|---------------------|-------------|------------------|-------------|
|                  |                   |               |       |                 | V/f Control         | V/f with PG | Open Loop Vector | Flux Vector |
| b3-02            | Spd Srch Current  | 0 to 200      | %     | 150             | Advanced            | ---         | Advanced         | ---         |
| b3-03            | Spd Srch Dec Time | 0.0 to 10.0   | Sec   | 2.0             | Advanced            | ---         | Advanced         | ---         |
| L2-03            | PwrL Baseblock t  | 0.0 to 0.5    | Sec   | 0.5 (see note)  | Basic or Advanced   |             |                  |             |

These parameters cannot be changed during operation.

**Note** The factory-set default varies depending on the Inverter capacity. The values shown in the table are for 200-V class, 0.4-kW.

- For the speed search operating current (b3-02), set the operating current for the speed search. If re-starting is not possible with the set value, then lower the set value. Set the speed search operating current as a percentage of the Inverter’s rated output current, with the Inverter’s rated output current taken as 100%.
- For the speed search deceleration time (b3-03), set the output frequency deceleration time for while the speed search is being performed.
- When the speed search and DC injection braking are set, set the minimum baseblock time (L2-03). For the minimum baseblock time, set the time to wait for the motor’s residual voltage to dissipate. If an overcurrent is detected when starting a speed search or DC injection braking, raise the set value to prevent a fault from occurring.

**Speed Search Timing Chart**

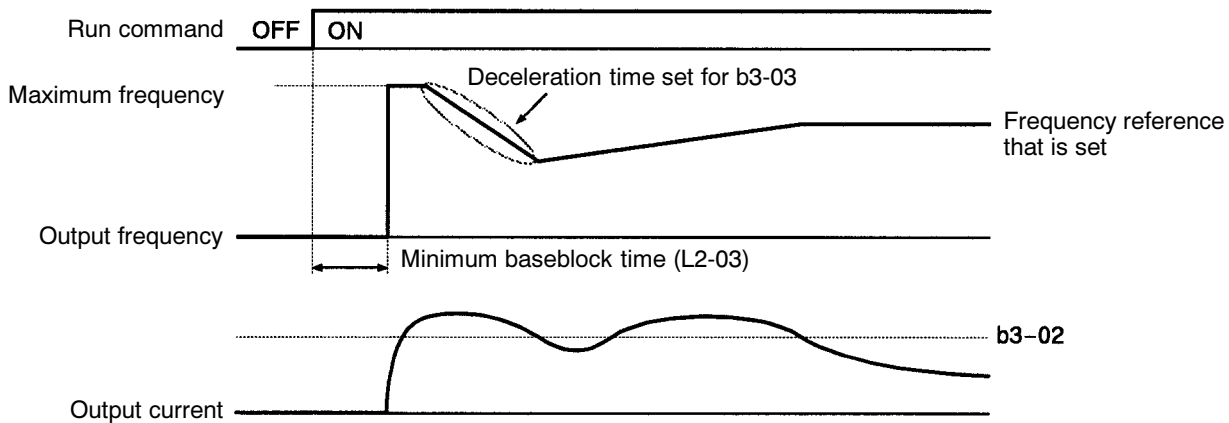

■ **Setting the Timer Function (b4)**

The timer function is enabled when the timer function input (set value: 18) and the timer function output (set value: 12) are set for the multi-function input and multi-function output respectively. These inputs and outputs serve as general-purpose I/O. Chattering of sensors, switches, and so on, can be prevented by setting a delay time.

| Parameter number | Display name    | Setting range | Units | Default setting | Valid access levels |             |                  |             |
|------------------|-----------------|---------------|-------|-----------------|---------------------|-------------|------------------|-------------|
|                  |                 |               |       |                 | V/f Control         | V/f with PG | Open Loop Vector | Flux Vector |
| b4-01            | Delay-ON Timer  | 0.0 to 300.0  | Sec   | 0.0             | Advanced            |             |                  |             |
| b4-02            | Delay-OFF Timer | 0.0 to 300.0  | Sec   | 0.0             | Advanced            |             |                  |             |

These parameters cannot be changed during operation.

- When the timer function input ON time is longer than the value set for b4-01 (timer function ON-delay time), the timer function output turns ON.
- When the timer function input OFF time is longer than the value set for b4-02 (timer function OFF-delay time), the timer function output turns OFF.

**Operation Example**

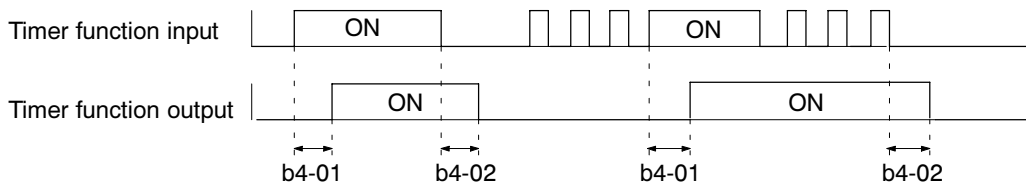

■ **Setting PID Control (b5)**

The PID control function is a control system that matches a feedback value (i.e., a detected value) to the set target value. Combining proportional (P), integral (I), and derivative (D) control makes control possible even for a mechanical system with dead time. The PID control provided by the SYSDRIVE 3G3FV Inverter is not suited for control that requires a responsiveness of 50 ms or less.

This section explains the PID control applications and operations, along with the parameter settings and tuning procedure.

● **PID Control Applications**

The following table shows examples of PID control applications using the Inverter.

| Application         | Control contents   | Sensors used (example)     |
|---------------------|--|----------------------------|
| Speed control       | Speeds are matched to target values as speed information in a mechanical system.<br>Speed information for another mechanical system is input as target values, and synchronized control is executed by feeding back actual speeds. | Tacho-generator            |
| Pressure control    | Pressure information is returned as feedback for stable pressure control.  | Pressure sensor            |
| Flow control        | Flow information is returned as feedback for accurate flow control.  | Flow sensor                |
| Temperature control | Temperature information is returned as feedback to control temperature by turning a fan.   | Thermocouple<br>Thermistor |

● **PID Control Operations**

In order to distinguish the separate PID control operations (i.e., proportional, integral, and derivative), the following diagram shows the changes in the control input (i.e., the output frequency) when the deviation between the target value and the feedback is held constant.

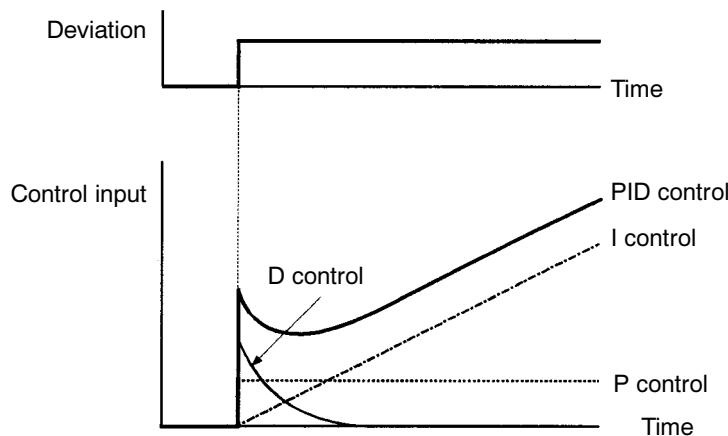

● **P Control**

A control input proportional to the deviation is output. The deviation cannot be zeroed by P control alone.

● **I Control**

A control input which is an integral of the deviation is output. This is effective for matching the feedback to the target value. Sudden changes, however, cannot be followed.

● **D Control**

A control input which is an integral of the deviation is output. Quick response to sudden changes is possible.

● **PID Control**

Optimum control is achieved by combining the best features of P, I, and D control.

● **Types of PID Control**

Two types of PID control are possible with the 3G3FV: measured-value derivative PID control and basic PID control. The type that is normally used is measured-value derivative PID control.

• Measured-value Derivative PID Control

With measured-value derivative PID control, the feedback value is differentiated for PID control. Response is possible with respect to changes both in target values and the control object.

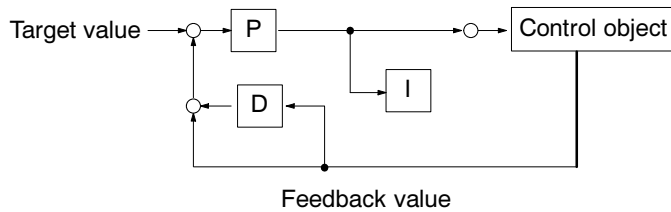

• Basic PID Control

This is the basic form of PID control. When the D control response is adjusted to follow changes in the control object, overshooting and undershooting can occur with changes in the target value.

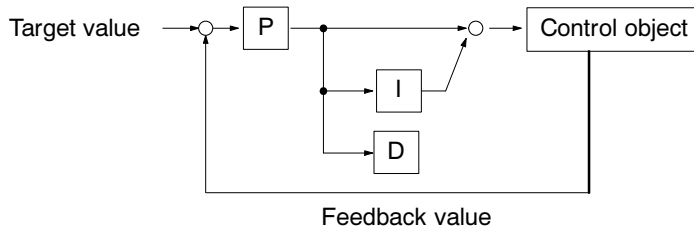

• Inverter's PID Control Function

The following illustration is a block diagram of the Inverter's internal PID control.

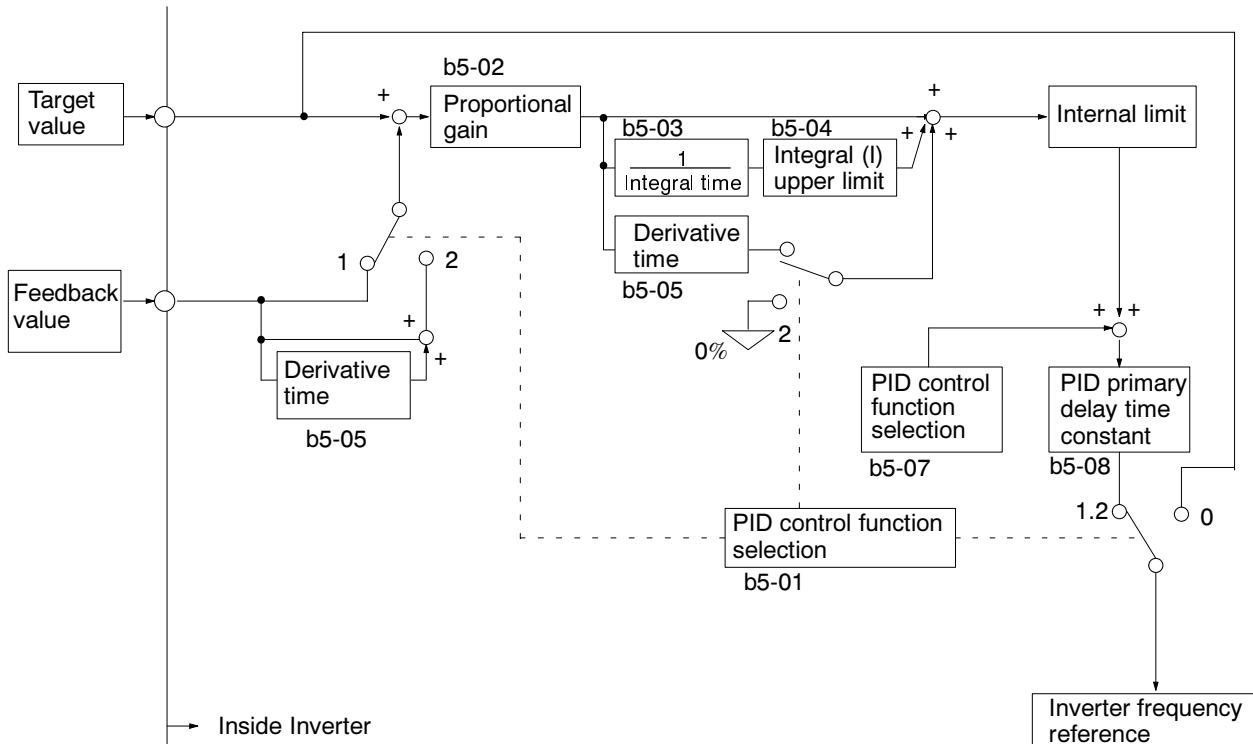

● PID Control Settings

| Parameter number | Display name | Setting range | Units | Default setting | Valid access levels |             |                  |             |
|------------------|--------------|---------------|-------|-----------------|---------------------|-------------|------------------|-------------|
|                  |              |               |       |                 | V/f Control         | V/f with PG | Open Loop Vector | Flux Vector |
| b5-01            | PID Mode     | 0 to 2        | ---   | 0               | Advanced            |             |                  |             |

This parameter cannot be changed during operation.

| Set value | Contents  |
|-----------|---|
| 0         | PID disabled  |
| 1         | PID enabled (Deviation signal is put through derivative control.) |
| 2         | PID enabled (Feedback signal is put through derivative control.)  |

To enable PID control, set either “1” or “2.” (Normally “2” is used, for measured-value derivative PID control).

When PID control is enabled, the target value input is determined by parameter b1-01 (reference selection).

The feedback value is input from a multi-function analog input terminal or frequency reference (current) terminal. Set PID feedback (set value: B) for either the parameter H3-05 (multi-function analog input, terminal 16), or parameter H3-09 (multi-function analog input, terminal 14) function selection.

Adjust the amount of feedback by setting the gain and bias of the analog inputs that are used.

Adjust the responsiveness of the PID control by means of the proportional gain (P), integral time (I), and derivative time (D).

| Parameter number | Display name | Setting range | Units    | Default setting | Valid access levels |             |                  |             |
|------------------|--------------|---------------|----------|-----------------|---------------------|-------------|------------------|-------------|
|                  |              |               |          |                 | V/f Control         | V/f with PG | Open Loop Vector | Flux Vector |
| b5-02            | PID Gain     | 0.00 to 10.00 | Multiple | 1.00            | Advanced            |             |                  |             |
| b5-03            | PID I Time   | 0.0 to 360.0  | Sec      | 1.0             | Advanced            |             |                  |             |
| b5-05            | PID D Time   | 0.0 to 10.00  | Sec      | 0.00            | Advanced            |             |                  |             |

These parameters cannot be changed during operation.

**Explanation of Set Values**

- Optimize the responsiveness by adjusting it while operating an actual load (mechanical system). (Refer to *Adjusting PID Control* on page 6-44.)
- Any control (P, I, or D) that is set to zero (0.0, 0.00) will not operate.

| Parameter number | Display name | Setting range | Units | Default setting | Valid access levels |             |                  |             |
|------------------|--------------|---------------|-------|-----------------|---------------------|-------------|------------------|-------------|
|                  |              |               |       |                 | V/f Control         | V/f with PG | Open Loop Vector | Flux Vector |
| b5-04            | PID I Limit  | 0.0 to 100.0  | %     | 100.0           | Advanced            |             |                  |             |

This parameter cannot be changed during operation.

**Explanation of Set Values**

- This parameter prevents the calculated value of the integral control in the PID control from exceeding the fixed amount.



- Parameter b5-04 is preset at the factory to the optimum value for most applications, so there is normally no need to change the setting.
- Reduce the set value if there is a risk of load damage, or of the motor going out of step, by the Inverter’s response when the load suddenly changes. If the set value is reduced too much, the target value and the feedback value will not match.
- Set this parameter as a percentage of the maximum frequency, with the maximum frequency taken as 100%.

| Parameter number | Display name | Setting range | Units | Default setting | Valid access levels |             |                  |             |
|------------------|--------------|---------------|-------|-----------------|---------------------|-------------|------------------|-------------|
|                  |              |               |       |                 | V/f Control         | V/f with PG | Open Loop Vector | Flux Vector |
| b5-06            | PID Limit    | 0.0 to 100.0  | %     | 100.0           | Advanced            |             |                  |             |

This parameter cannot be changed during operation.

**Explanation of Set Values**

- Parameter b5-06 prevents the frequency reference after PID control from exceeding the fixed amount.
- Set this parameter as a percentage of the maximum frequency, with the maximum frequency taken as 100%.

| Parameter number | Display name | Setting range   | Units | Default setting | Valid access levels |             |                  |             |
|------------------|--------------|-----------------|-------|-----------------|---------------------|-------------|------------------|-------------|
|                  |              |                 |       |                 | V/f Control         | V/f with PG | Open Loop Vector | Flux Vector |
| b5-07            | PID Offset   | -100.0 to 100.0 | %     | 0.0             | Advanced            |             |                  |             |

This parameter cannot be changed during operation.

**Explanation of Set Values**

- Parameter b5-07 adjusts the PID control offset.
- If both the target value and the feedback value are set to zero, adjust the Inverter’s output frequency to zero.

| Parameter number | Display name   | Setting range | Units | Default setting | Valid access levels |             |                  |             |
|------------------|----------------|---------------|-------|-----------------|---------------------|-------------|------------------|-------------|
|                  |                |               |       |                 | V/f Control         | V/f with PG | Open Loop Vector | Flux Vector |
| b5-08            | PID Delay Time | 0.00 to 10.00 | Sec   | 0.00            | Advanced            |             |                  |             |

This parameter cannot be changed during operation.

**Explanation of Set Values**

- Parameter b5-08 is the low-pass filter setting for PID control outputs.
- Parameter b5-08 is preset at the factory to the optimum value for most applications, so there is normally no need to change the setting.
- If the viscous friction of the mechanical system is high, or if the rigidity is low, causing the mechanical system to vibrate, increase the set value so that it is higher than the vibration frequency period. This will decrease the responsiveness, but it will prevent the vibration.

- **Adjusting PID Control**
- **Step Response**

This section explains how to adjust PID control parameters while observing the step response of the control object.

### 1. Measuring the Step Response Waveform

Use the following procedure to measure the step response waveform.

- a) Connect a load under the same conditions as for normal operation.
- b) Set parameter b5-01 to "0" (PID control disabled).
- c) Set the Inverter's acceleration time as low as possible, and input the step frequency reference.
- d) Measure the response waveform of the feedback (i.e., the detection value).

**Note** Conduct the measurement so as to know the timing with the step input.

### 2. Calculating the PID Parameters

- Draw a tangential line at the steepest point of the gradient of the step response waveform measured in procedure 1.

- **Measuring R**

Measure the inclination of the tangential line, with the target value as "1."

- **Measuring L**

Measure the time (unit: seconds) until the tangential line from the beginning of the step input joins the time axis.

- **Measuring T**

Measure the time (unit: seconds) from the point where the tangential line joins the time axis to the point where it meets the target value.

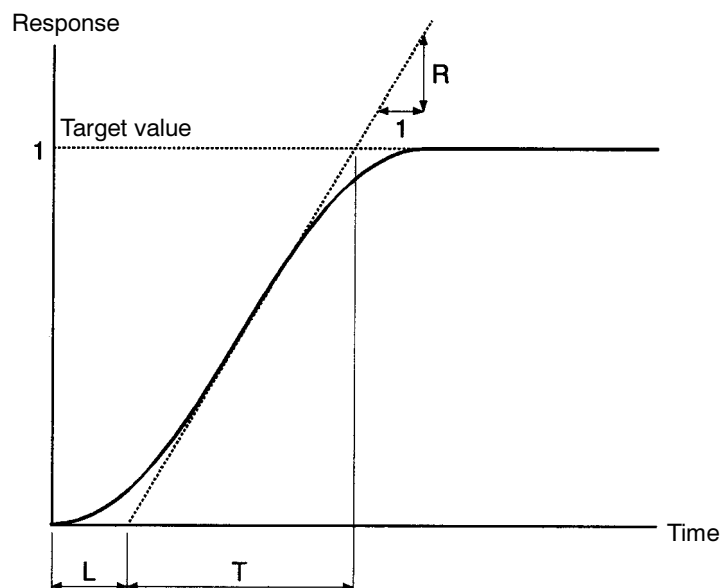

• **Calculating the PID Parameters**

The PID parameters can be calculated from the R, L, and T values measured above, as shown in the following table.

|             | Proportional gain (P)<br>(b5-02) | Integral time (I)<br>(b5-03) | Derivative time (D)<br>(b5-05) |
|-------------|----------------------------------|------------------------------|--------------------------------|
| P control   | 0.3/RL                           | ---                          | ---                            |
| PI control  | 0.35/RL                          | 1.2T                         | ---                            |
| PID control | 0.6/RL                           | T                            | 0.5L                           |

First set the PID control parameters by this method, and then make fine adjustments.

If the viscous friction of the mechanical system is high, or if the rigidity is low, these set values may not be optimum.

• **Making Manual Adjustments**

Use the following procedure to make adjustments while using PID control and observing the response waveform.

1. Set parameter b5-01 to "1" or "2" (PID control enabled).
2. Increase the proportional gain P (b5-02) in the non-vibration range.
3. Decrease the integral time I (b5-03) in the non-vibration range.
4. Decrease the derivative time I (b5-05) in the non-vibration range.

• **Making Fine Adjustments**

First set the individual PID control parameters, and then make fine adjustments.

• **Reducing Overshooting**

If overshooting occurs, shorten the derivative time (D) and lengthen the integral time (I).

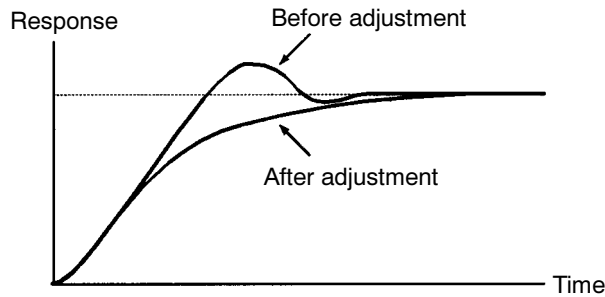

• **Rapidly Stabilizing Control Status**

To rapidly stabilize the control conditions even when overshooting occurs, shorten the integral time (I) and lengthen the derivative time (D).

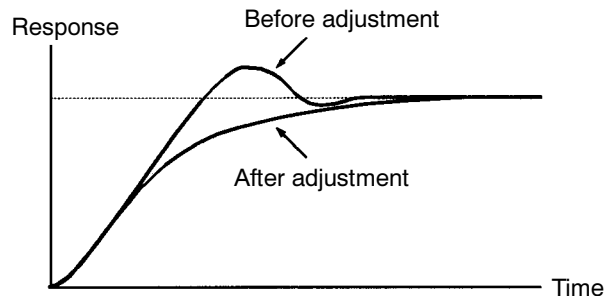

• Reducing Long-cycle Vibration

If vibration occurs with a longer cycle than the integral time (I) set value, it means that integral operation is strong. The vibration will be reduced as the integral time (I) is lengthened.

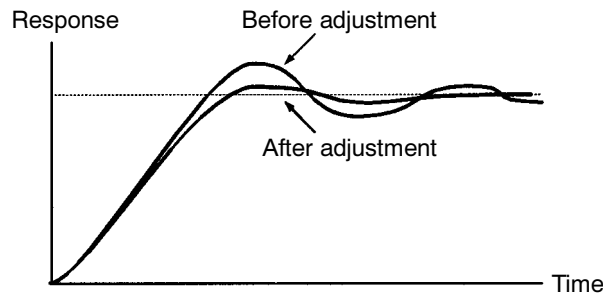

• Reducing Short-cycle Vibration

If the vibration cycle is short and vibration occurs with a cycle approximately the same as the derivative time (D) set value, it means that the derivative operation is strong. The vibration will be reduced as the derivative time (D) is shortened.

If vibration cannot be reduced even by setting the derivative time (D) to “0.00” (no derivative control), then either lower the proportional gain (P) or raise the PID’s primary delay time constant.

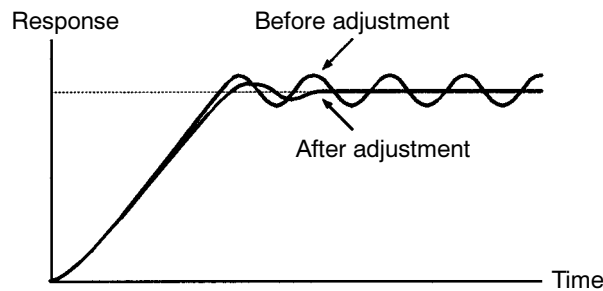

■ Setting the Reference Hold Function (b6)

The reference hold or dwell function is used to temporarily hold the output frequency when starting or stopping a motor with a heavy load. This helps to prevent stalling.

| Parameter number | Display name     | Setting range | Units | Default setting | Valid access levels |             |                  |             |
|------------------|------------------|---------------|-------|-----------------|---------------------|-------------|------------------|-------------|
|                  |                  |               |       |                 | V/f Control         | V/f with PG | Open Loop Vector | Flux Vector |
| b6-01            | Dwell Ref @Start | 0.0 to 400.0  | Hz    | 0.0             | Advanced            |             |                  |             |
| b6-02            | Dwell Time@Start | 0.0 to 10.0   | Sec   | 0.0             | Advanced            |             |                  |             |
| b6-03            | Dwell Ref @Stop  | 0.0 to 400.0  | Hz    | 0.0             | Advanced            |             |                  |             |
| b6-04            | Dwell Time @Stop | 0.0 to 10.0   | Sec   | 0.0             | Advanced            |             |                  |             |

These parameters cannot be changed during operation.

The relation between these parameters is shown in the following diagram.

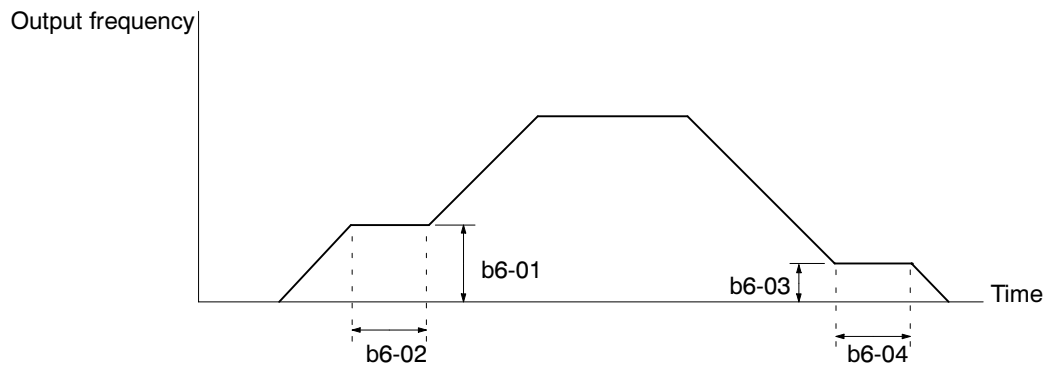

### 6-5-3 Tuning Parameters (C)

#### ■ Setting the S-curve Characteristic Function (C2)

- Using the S-curve characteristic function for acceleration and deceleration can reduce shock to the machinery when stopping and starting.
- With the SYSDRIVE 3G3FV, S-curve characteristic times can be set respectively for beginning acceleration, ending acceleration, beginning deceleration, and ending deceleration.

| Parameter number | Display name     | Setting range | Units | Default setting | Valid access levels |             |                  |             |
|------------------|------------------|---------------|-------|-----------------|---------------------|-------------|------------------|-------------|
|                  |                  |               |       |                 | V/f Control         | V/f with PG | Open Loop Vector | Flux Vector |
| C2-01            | SCrv Acc @ Start | 0.00 to 2.50  | Sec   | 0.20            | Advanced            |             |                  |             |
| C2-02            | SCrv Acc @ End   | 0.00 to 2.50  | Sec   | 0.20            | Advanced            |             |                  |             |
| C2-03            | SCrv Dec @ Start | 0.00 to 2.50  | Sec   | 0.20            | Advanced            |             |                  |             |
| C2-04            | SCrv Dec @ End   | 0.00 to 2.50  | Sec   | 0.20            | Advanced            |             |                  |             |

These parameters cannot be changed during operation.

- The relation between these parameters is shown in the following diagram.

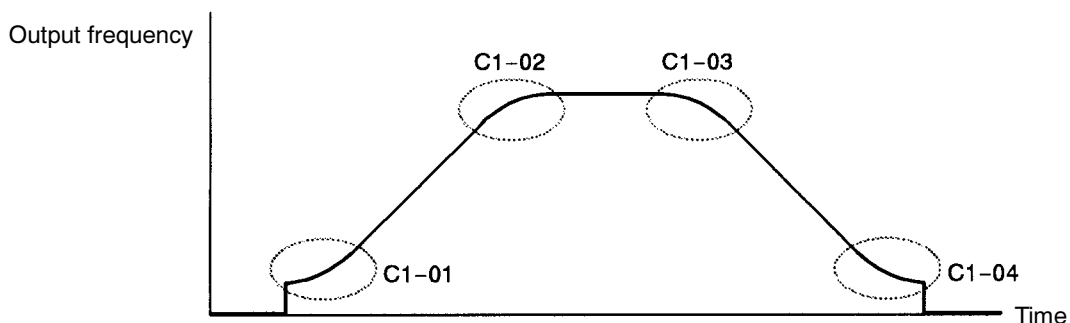

**Note** When the S-curve characteristic time is set, the acceleration and deceleration times will be lengthened as follows:

$$\text{Acceleration time} = \text{Selected acceleration time} + (\text{S-curve at beginning of acceleration} + \text{S-curve at end of acceleration}) / 2$$

$$\text{Deceleration time} = \text{Selected deceleration time} + (\text{S-curve at beginning of deceleration} + \text{S-curve at end of deceleration}) / 2$$

■ **Setting Motor Slip Compensation (C3)**

- The motor slip compensation function calculates the motor torque according to the output current, and sets gain to compensate for output frequency.
- This function is used to improve speed accuracy when operating with a load. It is mainly effective with V/f control (without PG).

| Parameter number | Display name   | Setting range | Units     | Default setting | Valid access levels |             |                   |             |
|------------------|----------------|---------------|-----------|-----------------|---------------------|-------------|-------------------|-------------|
|                  |                |               |           |                 | V/f Control         | V/f with PG | Open Loop Vector  | Flux Vector |
| C3-01            | Slip Come Gain | 0.0 to 2.5    | Multi-ple | 1.0 (See note.) | Basic or Adv.       | ---         | Basic or Advanced |             |

This parameter can be changed during operation.

**Note** When the control mode is switched, the factory default setting changes as follows:  
 V/f control: 0.0; V/f with PG: 1.0; open-loop vector 0; flux vector: 1.0

When “1.0” is set, this function compensates for the rated slip that has been set, by the rated torque output.

With flux vector control, this becomes the gain to compensate for slip caused by motor temperature variation. (Refer to page 6-29.)

• **Motor Slip Compensation Gain Adjustment Procedure**

1. Correctly set the motor rated slip (parameter E2-02) and the motor no-load current (parameter E2-03). The motor rated slip can be calculated by means of the following equation, using the numbers that are shown on the motor’s nameplate.

$$\text{Motor rated slip} = \text{Motor rated frequency (Hz)} - \text{rated speed (r/min)} \times \text{motor (No. of poles)} / 120$$

(With vector control, the motor rated slip is automatically set by auto-tuning.)

2. Set the slip compensation gain (parameter C3-01 to “1.0.” (If it is set to “0.0,” slip compensation will be disabled.)
3. Operate with a load, measure the speed, and adjust the slip compensation gain (in increments of 0.1). If the speed is lower than the target value, increase the slip compensation gain. If the speed is higher than the target value, decrease the slip compensation gain.

| Parameter number | Display name   | Setting range | Units | Default setting | Valid access levels |             |                  |             |
|------------------|----------------|---------------|-------|-----------------|---------------------|-------------|------------------|-------------|
|                  |                |               |       |                 | V/f Control         | V/f with PG | Open Loop Vector | Flux Vector |
| C3-02            | Slip Come Time | 0 to 10000    | ms    | 200 (See note.) | Adv.                | ---         | Advanced         | ---         |

This parameter cannot be changed during operation.

**Note** When the control mode is switched, the values change as follows:  
 V/f control: 2,000; open-loop vector: 200

Adjust the slip compensation primary delay time if the motor slip compensation responsiveness is low, or if the speeds are unstable. (This does not normally need to be set.) If responsiveness is low, lower the set value. If speeds are unstable, raise the set value.

| Parameter number | Display name    | Setting range | Units | Default setting | Valid access levels |             |                  |             |
|------------------|-----------------|---------------|-------|-----------------|---------------------|-------------|------------------|-------------|
|                  |                 |               |       |                 | V/f Control         | V/f with PG | Open Loop Vector | Flux Vector |
| C3-03            | Slip Come Limit | 0 to 250      | %     | 200             | Adv.                | ---         | Advanced         | ---         |

This parameter cannot be changed during operation.

Parameter C3-03 sets the slip compensation limit as a percentage of motor rated slip (E2-02), with the motor rated slip taken as 100%.

If the speed is lower than the target value and does not change even when the slip compensation gain is adjusted, it is possible that the slip compensation limit has been reached. Raise the limit and then check again. Make sure, however, that the value of the sum of the command frequency and the slip compensation limit does not exceed the speed capacity of the machinery.

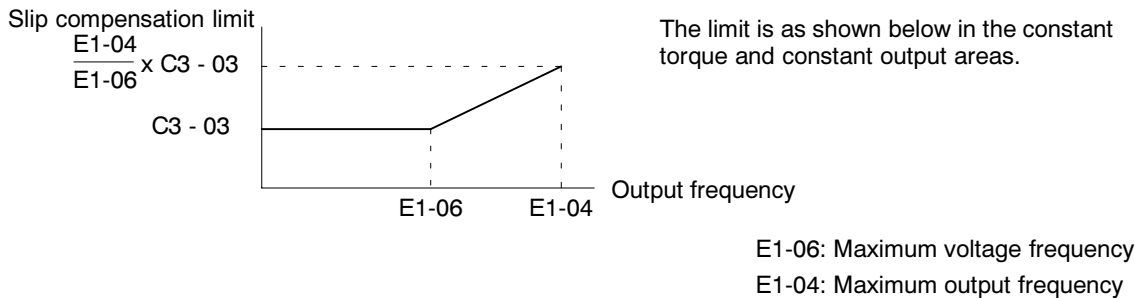

| Parameter number | Display name    | Setting range | Units | Default setting | Valid access levels |             |                  |             |
|------------------|-----------------|---------------|-------|-----------------|---------------------|-------------|------------------|-------------|
|                  |                 |               |       |                 | V/f Control         | V/f with PG | Open Loop Vector | Flux Vector |
| C3-04            | Slip Come Regen | 0, 1          | ---   | 0               | Advanced            |             |                  | ---         |

This parameter cannot be changed during operation.

**Explanation of Set Value**

| Set value | Contents                                       |
|-----------|--|
| 0         | Slip compensation disabled during regeneration |
| 1         | Slip compensation enabled during regeneration  |

Parameter C3-04 enables or disables slip compensation during regeneration. The amount of regeneration is momentarily increased when this function is used, so some control option (e.g., control resistor, Control Resistor Unit, Braking Unit) may be required.

**■ Setting the Torque Compensation Function (C4)**

The torque compensation function detects increases in the motor load, and increases the output torque to compensate.

| Parameter number | Display name   | Setting range | Units    | Default setting | Valid access levels |             |                  |             |
|------------------|----------------|---------------|----------|-----------------|---------------------|-------------|------------------|-------------|
|                  |                |               |          |                 | V/f Control         | V/f with PG | Open Loop Vector | Flux Vector |
| C4-01            | Torq Comp Gain | 0.00 to 2.50  | Multiple | 1.00            | Advanced            |             |                  | ---         |

This parameter can be changed during operation, but normally no adjustments are required. Make adjustments in the following cases:

- If the wiring distance between the Inverter and the motor is long, raise the set value.
- If the motor capacity is less than the Inverter capacity (the maximum application motor capacity), raise the set value.
- If the motor generates excessive vibration, lower the set value.

Set the torque compensation gain so that the output current at low-speed rotation does not exceed 50% of the Inverter’s rated output current. If the setting exceeds 50% of the Inverter’s rated output current, the Inverter may be damaged.

| Parameter number | Display name   | Setting range | Units | Default setting | Valid access levels |             |                  |             |
|------------------|----------------|---------------|-------|-----------------|---------------------|-------------|------------------|-------------|
|                  |                |               |       |                 | V/f Control         | V/f with PG | Open Loop Vector | Flux Vector |
| C4-02            | Torq Comp Time | 0 to 10000    | ms    | (See note.)     | Advanced            |             |                  |             |

This parameter cannot be changed during operation.

**Note** When the control mode is switched, the factory default setting changes as follows:  
 V/f control: 200; V/f with PG: 200; open-loop vector 20

The torque compensation time constant does not normally need to be adjusted, but make adjustments in the following cases:

- If the motor generates excessive vibration, raise the set value.
- If motor responsiveness is low, lower the set value.

### ■ Setting the Carrier Frequency (C6)

The carrier frequency characteristics differ according to the control mode.

- V/f control and V/f with PG control: Carrier frequency variable setting possible.
- Open-loop vector control and flux vector control: Constant frequency (The carrier frequency upper limit only is set.)

The carrier frequency does not normally need to be adjusted, but make adjustments in the following cases:

- If the wiring distance between the Inverter and the motor is long, lower the carrier frequency. The standards are 15 mHz or less for a wiring distance of 50 meters or less; 10 mHz or less for 100 meters or less; and 5 mHz or less for over 100 meters.
- If there are great irregularities in speed or torque, lower the carrier frequency.



Setting the Carrier Frequency and Inverter Overload “OL2”

For a 400-V Inverter, if the carrier frequency is set to a value higher than the default setting, the Inverter overload detection value will decrease in consideration of an increase in the heat that will be generated by the change in the carrier frequency. Since the detection value is set to decrease by approximately 15% for an increase of 2 kHz, carefully set the frequency so that the rated motor current can be output.

| Parameter number | Display name      | Setting range              | Units    | Default setting | Valid access levels |             |                  |             |
|------------------|-------------------|----------------------------|----------|-----------------|---------------------|-------------|------------------|-------------|
|                  |                   |                            |          |                 | V/f Control         | V/f with PG | Open Loop Vector | Flux Vector |
| C6-01            | Carrier Freq Max  | 0.4 to 15.0<br>(See note.) | kHz      | (See note.)     | Basic or Advanced   |             |                  |             |
| C6-02            | Carrier Freq Min  | 0.4 to 15.0<br>(See note.) | kHz      | (See note.)     | Advanced            | ---         |                  |             |
| C6-03            | Carrier Freq Gain | 0 to 99                    | Multiple | 0               | Advanced            | ---         |                  |             |

These parameters cannot be changed during operation.

**Note** The setting range and the factory default setting vary according to the Inverter capacity. The table shows a value of 200-V class, 0.4 kW.

In the vector control modes, the carrier frequency is determined by the carrier frequency upper limit (parameter C6-01).

In the V/f control modes (both with and without PG), the carrier frequency can be changed in response to the output frequency by setting the carrier frequency lower limit (parameter C6-02) and the carrier frequency proportional gain (parameter C6-03).

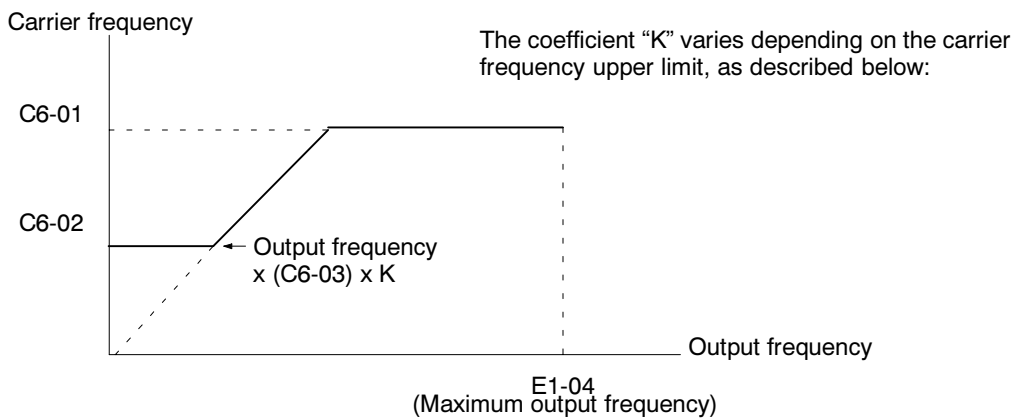

To make the carrier frequency constant, either set the same value for parameters C6-01 and C6-02 or set the carrier frequency proportional gain (parameter C6-03) to “0” (i.e., fix at upper limit value).

The following settings will generate a parameter setting fault (OPE11):

Carrier frequency upper limit (C6-01) > 5.0 kHz and carrier frequency lower limit (c6-02) ≤ 5.0 kHz

Carrier frequency proportional gain (C6-03) > 6 and (C6-01) < C6-02

If the lower limit is set higher than the upper limit, the lower limit will be ignored and carrier frequency will be fixed at the upper limit.

### 6-5-4 Reference Parameters (d)

#### ■ Setting the Frequency Reference Function (d2)

The frequency reference function sets the output frequency upper and lower limits.

When the frequency reference is zero and a run command is input, the motor operates at the frequency reference lower limit (d2-02). The motor will not operate, however, if the lower limit is set lower than the minimum output frequency (E1-09).

| Parameter number | Display name    | Setting range | Units | Default setting | Valid access levels |             |                  |             |
|------------------|-----------------|---------------|-------|-----------------|---------------------|-------------|------------------|-------------|
|                  |                 |               |       |                 | V/f Control         | V/f with PG | Open Loop Vector | Flux Vector |
| d2-01            | Ref Upper Limit | 0.0 to 110.0  | %     | 100.0           | Basic or Advanced   |             |                  |             |
| d2-02            | Ref Lower Limit | 0.0 to 109.0  | %     | 0.0             | Basic or Advanced   |             |                  |             |

These parameters cannot be changed during operation.

**Note** The frequency reference upper and lower limits are set as a percentage of the maximum output frequency (E1-04), in increments of 1%.

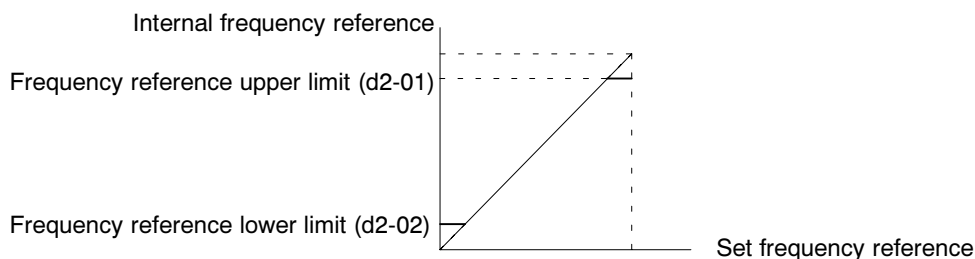

#### ■ Setting Prohibiting Frequency (Jump Frequencies) (d3)

This function allows the prohibition or “jumping” of certain frequencies within the Inverter’s output frequency range so that the motor can operate without resonant vibrations caused by some machine systems. It is also used for deadband control.

| Parameter number | Display name   | Setting range | Units | Default setting | Valid access levels |             |                  |             |
|------------------|----------------|---------------|-------|-----------------|---------------------|-------------|------------------|-------------|
|                  |                |               |       |                 | V/f Control         | V/f with PG | Open Loop Vector | Flux Vector |
| d3-01            | Jump Freq 1    | 0.0 to 400.0  | Hz    | 0.0             | Basic or Advanced   |             |                  |             |
| d3-02            | Jump Freq 2    | 0.0 to 400.0  | Hz    | 0.0             | Basic or Advanced   |             |                  |             |
| d3-03            | Jump Freq 3    | 0.0 to 400.0  | Hz    | 0.0             | Basic or Advanced   |             |                  |             |
| d3-04            | Jump Bandwidth | 0.0 to 20.0   | Hz    | 1.0             | Basic or Advanced   |             |                  |             |

These parameters cannot be changed during operation.

To disable this function, set the jump frequency references (d3-01 to d3-03) to 0.0 Hz.

For d3-01 to d3-03, set the center values of the frequencies to be jumped.

For d3-04, set the jump frequency bandwidth. The jump frequency ± the jump bandwidth becomes the jump frequency range.

Operation is prohibited within the jump frequency range, but changes during acceleration and deceleration are smooth with no jumps.

Be sure to set the jump frequency so that  $d3-03 \leq d3-02 \leq d3-01$ .

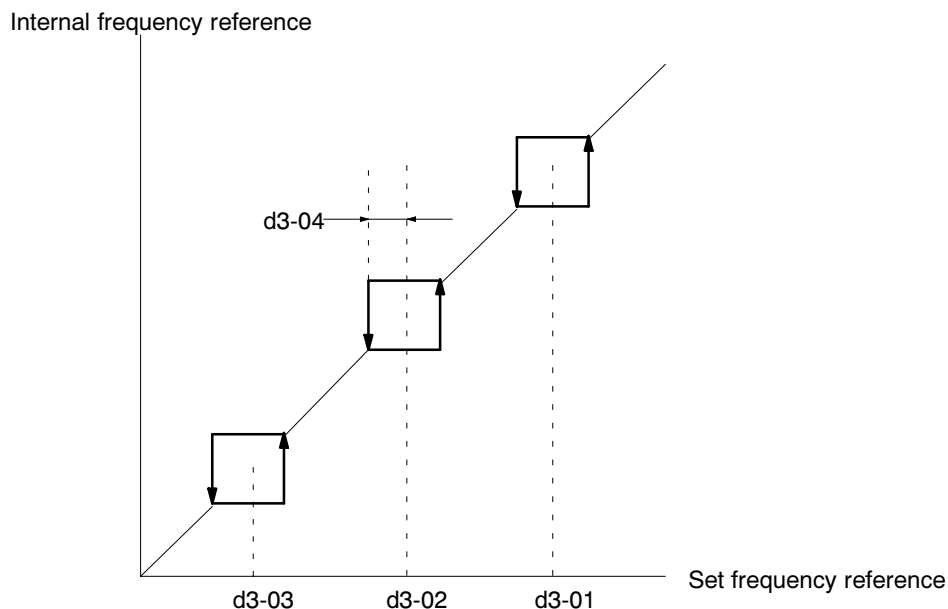

### ■ Hold Reference Memory Selection (d4-01)

Parameter d4-01 selects whether the held frequency during motor operated potentiometer (MOP) simulation operation is stored when operation is stopped. MOP operation is enabled by making either of the following settings for the multi-function inputs (H1-01 to H1-06).

Accel/decel ramp hold (set value: A)

UP command (set value: 10)/DOWN command (set value: 11) {MOP increase/decrease}

When hold status is established by these external signals, specify whether or not the output frequency is to be retained.

When this function is enabled, operation is re-started after power-up using the frequency reference value that was retained.

| Parameter number | Display name   | Setting range | Units | Default setting | Valid access levels |             |                  |             |
|------------------|----------------|---------------|-------|-----------------|---------------------|-------------|------------------|-------------|
|                  |                |               |       |                 | V/f Control         | V/f with PG | Open Loop Vector | Flux Vector |
| d4-01            | MOP Ref Memory | 0, 1          | ---   | 0               | Advanced            |             |                  |             |

This parameter cannot be changed during operation.

### Explanation of Settings

| Setting | Description  |
|---------|--|
| 0       | Disabled. Held frequency during MOP operation is not retained. If a stop command is given, or if power is removed, the frequency reference is reset to 0Hz. Restart after operation stoppage or power-up begins at zero. |
| 1       | Enabled. Held frequency during MOP operation is retained. If a stop command is given, or if power is removed, operation resumes at the held frequency reference when the run command is restored.                        |

For information regarding the accel/decel stop (HOLD) command and the UP and DOWN commands, refer to 6-5-6 External Terminal Function (H).

■ **Trim Control Level (d4-02)**

This function sets the motor operated “trim” control level as a percentage of maximum output frequency in units of 1%. When trim control increase and decrease are selected as multi-function contact input functions (setting: H1 \_\_ = “1C” and “1D” respectively), the trim control level is added to or subtracted from the analog frequency reference, when each respective contact closes.

| Parameter number | Display name     | Setting range | Units | Default setting | Valid access levels |             |                  |             |
|------------------|------------------|---------------|-------|-----------------|---------------------|-------------|------------------|-------------|
|                  |                  |               |       |                 | V/f Control         | V/f with PG | Open Loop Vector | Flux Vector |
| d4-02            | Trim Control Lvl | 0 to 100      | %     | 25              | Advanced            |             |                  |             |

This parameter cannot be changed during operation.

If the minus speed command is ON and the result of the subtraction is beyond zero, the output frequency will become zero.

For information regarding the plus and minus speed commands, refer to the explanations of the multi-function inputs (H1) in 6-5-6 External Terminal Function (H).

**6-5-5 Option Parameters (F)**

■ **Installing Optional Cards**

A maximum of three Optional Cards can be installed in the SYSDRIVE 3G3FV. The installation location of each is determined by the type of Card. Be sure to install the Cards in their correct locations.

● **Installation Procedure**

1. Turn off the Inverter’s main-circuit power supply. Wait at least one minute (or at least three minutes for models of 30 kW or more), and then remove the Inverter’s front cover. Check to be sure that the CHARGE light is turned OFF.
2. Check the Optional Card’s installation location (A, C, or D).

| Type of card           | Model         | Specifications                             | Location |
|------------------------|---------------|--|----------|
| Analog Reference Card  | 3G3IV-PAI14U  | 14-bit analog, 2 inputs (voltage/current)  | C        |
|                        | 3G3IV-PAI14B  | 14-bits analog, 3 inputs                   | C        |
| Digital Reference Card | 3G3IV-PDI08   | 8-bit digital input (BCD/binary)           | C        |
|                        | 3G3IV-PDI16H2 | 16-bit digital input (BCD/binary)          | C        |
| PG Speed Control Card  | 3G3FV-PPGA2   | Open-collector-compatible, single input    | A        |
|                        | 3G3FV-PPGB2   | Open-collector-compatible, A/B-phase input | A        |
|                        | 3G3FV-PPGD2   | Line-driver-compatible, single input       | A        |
|                        | 3G3FV-PPGX2   | Line-driver-compatible, A/B-phase input    | A        |
| Analog Monitor Card    | 3G3IV-PAO08   | 8-bit analog output, 2 channels            | D        |
|                        | 3G3IV-PAO12   | 12-bit analog output, 2 channels           | D        |
| Pulse Monitor Card     | 3G3IV-PPO36F  | Pulse frequency output                     | D        |

3. Insert the accessory spacer into the spacer mounting hole in the Inverter’s mounting base.
4. Align the Optional Card connector with the connector position on the control board, and then pass the spacer through the spacer mounting hole on the card. Press firmly until the spacer snaps into place.

5. Connect the Optional Card's FG connection line to the Inverter's FG terminal (terminal 12).

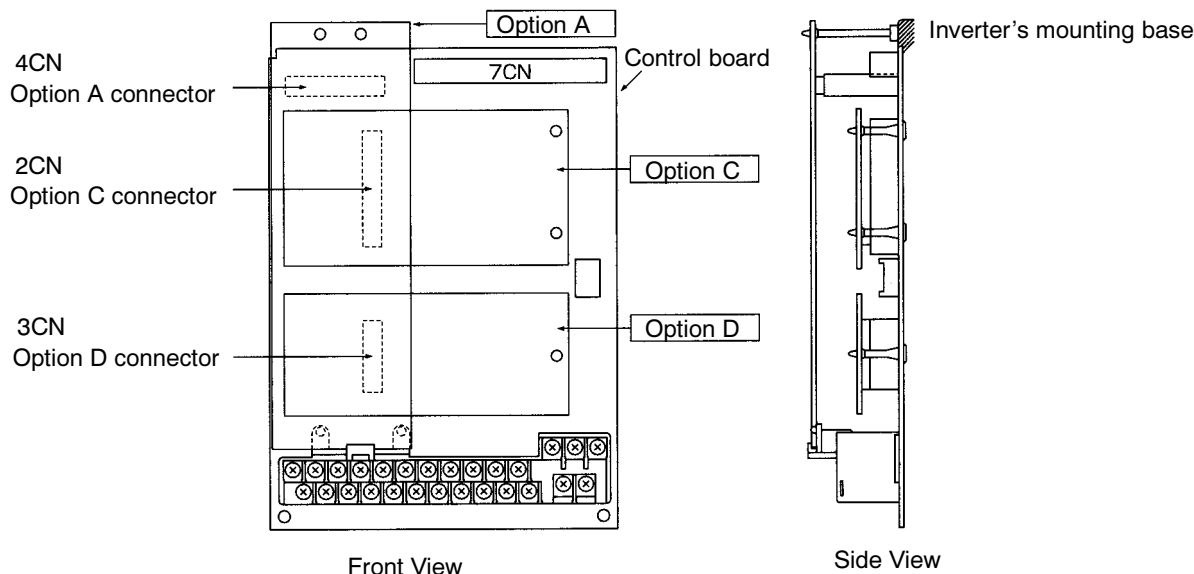

■ Setting a Analog Reference Card (F2)

When using a 3G3IV-PAI14B/PAI14U Analog Reference Card, set parameter b1-01 (reference selection) to “3” (option).

When using a 3G3IV-PAI14B, set the function for channels 1 to 3 with parameter F2-01. (There are no parameters to set for 3G3IV-PAI14U.)

| Parameter number | Display name    | Setting range | Units | Default setting | Valid access levels |             |                  |             |
|------------------|-----------------|---------------|-------|-----------------|---------------------|-------------|------------------|-------------|
|                  |                 |               |       |                 | V/f Control         | V/f with PG | Open Loop Vector | Flux Vector |
| F2-01            | AI-14 Input Sel | 0, 1          | ---   | 0               | Basic or Advanced   |             |                  |             |

This parameter cannot be changed during operation.

Explanation of Settings

| Setting | Description  |
|---------|--|
| 0       | 3-channel individual input (CH1: terminal 13; CH2: terminal 14; CH3: terminal 16;        |
| 1       | 3-channel additional input (Sum of CH1 to CH3 is used as the frequency reference value.) |

Parameter b1-01 (reference selection) must be set to “1” (external terminal), except for when 3-channel input (setting: 0) is set.

When using a 3G3IV-PAI14B, the multi-function input “Option/Inverter selection” function (setting: 2) cannot be used.

■ Setting a Digital Reference Card (F3)

When using a 3G3IV-PDI08/PD116H2 Digital Reference Card, set parameter b1-01 (reference selection) to “3” (option) and set the input method with parameter F3-01.

| Parameter number | Display name | Setting range | Units | Default setting | Valid access levels |             |                  |             |
|------------------|--------------|---------------|-------|-----------------|---------------------|-------------|------------------|-------------|
|                  |              |               |       |                 | V/f Control         | V/f with PG | Open Loop Vector | Flux Vector |
| F3-01            | DI Input     | 0 to 7        | ---   | 0               | Basic or Advanced   |             |                  |             |

This parameter cannot be changed during operation.

**Explanation of Settings**

| Setting | Description  |
|---------|--|
| 0       | BCD 1% unit  |
| 1       | BCD 0.1% unit  |
| 2       | BCD 0.01% unit   |
| 3       | BCD 1 Hz unit  |
| 4       | BCD 0.1 Hz unit  |
| 5       | BCD 0.01 Hz unit   |
| 6       | BCD special setting (5-digit input) (Only when 3G3FV-PD116H2 is used.) |
| 7       | Binary input (Set value is displayed in decimal notation.)             |

• When binary input is used (setting: 7), this becomes the maximum frequency (100% speed) reference when all bits are set to “1.”

3G3IV-PD108: Maximum frequency reference when FF<sub>H</sub> (255) is set.

3G3IV-PD116H2: Maximum frequency reference when FFFF<sub>H</sub> (65535) is set.

• Setting 6, BCD special setting (5-digit input), is valid only when the 3G3IV-PD116H2 is used.

|                        |                     |                     |                     |                     |                     |        |                     |                     |                     |                     |
|------------------------|---------------------|---------------------|---------------------|---------------------|---------------------|--------|---------------------|---------------------|---------------------|---------------------|
| <b>Setting: 1 to 5</b> | Sign                | 8 x 10 <sup>3</sup> | 4 x 10 <sup>3</sup> | 2 x 10 <sup>3</sup> | 1 x 10 <sup>3</sup> | to ... | 8 x 10 <sup>0</sup> | 4 x 10 <sup>0</sup> | 2 x 10 <sup>0</sup> | 1 x 10 <sup>0</sup> |
| <b>Setting: 6</b>      | 2 x 10 <sup>4</sup> | 1 x 10 <sup>4</sup> | 8 x 10 <sup>3</sup> | 4 x 10 <sup>3</sup> | 2 x 10 <sup>3</sup> | to ... | 1 x 10 <sup>1</sup> | 8 x 10 <sup>0</sup> | 4 x 10 <sup>0</sup> | 2 x 10 <sup>0</sup> |

The sign bit is used as a data bit, so only positive (plus) data can be set.

The second digit below the decimal point is set by bits 8x10<sup>0</sup>, 4x10<sup>0</sup>, and 2x10<sup>0</sup>, so the settings are made in units of 0.02 Hz. (If these three bits are “111,” “110,” and “101,” they will be recognized as “9.”)

**■ Setting an Analog Monitor Card (F4)**

When using a 3G3IV-PAO08/PAO12 Analog Monitor Card, set the monitor items and gain with the following parameters. Parameters F4-02 and F4-04 can be changed during operation, while F4-01 and F4-03 cannot.

| Parameter number | Display name  | Setting range | Units     | Default setting | Valid access levels |             |                  |             |
|------------------|---------------|---------------|-----------|-----------------|---------------------|-------------|------------------|-------------|
|                  |               |               |           |                 | V/f Control         | V/f with PG | Open Loop Vector | Flux Vector |
| F4-01            | AO Ch1 Select | 1 to 31       | ---       | 2               | Basic or Advanced   |             |                  |             |
| F4-02            | AO Ch1 Gain   | 0.00 to 2.50  | Multi-ple | 1.00            | Basic or Advanced   |             |                  |             |
| F4-03            | AO Ch2 Select | 1 to 31       | ---       | 3               | Basic or Advanced   |             |                  |             |
| F4-04            | AO Ch2 Gain   | 0.00 to 2.50  | Multi-ple | 0.50            | Basic or Advanced   |             |                  |             |

For the output monitor selections (F4-01, F4-03), set the numbers for the right side of the “U1” constants in the table on page 3-12 of this manual. (For example, for “U1-01,” set “01.”) The setting range is 1 to 31, but the following numbers cannot be set: 4, 10, 11, 12, 13, 14, 25, 28.

When the 3G3IV-PAO12 is used, outputs of 0 to ±10 V are possible. For that, set parameter H4-07 (multi-function analog output signal level selection) to “1” (0 to ±10-V outputs). There are some monitor items, however, that can only use outputs of 0 to +10 V even if parameter H4-07 is set to “1.”

When the 3G3IV-PAO08 is used, only outputs of 0 to +10 V are possible regardless of the parameter H4-07 setting.

■ **Setting a Pulse Monitor Card (F7)**

When using a 3G3IV-PPO36F Pulse Monitor Card, set the number of output pulses with parameter F7-01.

| Parameter number | Display name     | Setting range | Units | Default setting | Valid access levels |             |                  |             |
|------------------|------------------|---------------|-------|-----------------|---------------------|-------------|------------------|-------------|
|                  |                  |               |       |                 | V/f Control         | V/f with PG | Open Loop Vector | Flux Vector |
| F7-01            | PO-36F Selection | 0 to 4        | ---   | 1               | Basic or Advanced   |             |                  |             |

**Explanation of Settings**

| Setting | Description |
|---------|-------------|
| 0       | 1F          |
| 1       | 6F          |
| 2       | 10F         |
| 3       | 12F         |
| 4       | 36F         |

**Note** “F” indicates the output frequency (Hz). For example, if “0” (1F) is set, when the output frequency is 60 Hz there will be an output of 60 pulses per minute. (Duty 50%)

### 6-5-6 External Terminal Functions: H

#### ■ Multi-function Input Settings (H1)

| Setting | Function  | Control mode |          |                  |             |
|---------|---|--------------|----------|------------------|-------------|
|         |   | V/f          | V/f w/PG | Open-loop Vector | Flux Vector |
| 0       | 3-Wire Control (with a forward/reverse rotation input)  | OK           | OK       | OK               | OK          |
| 1       | Local/Remote Selection (operation signal selection)   | OK           | OK       | OK               | OK          |
| 2       | Option/Inverter Selection (ON: Optional Card)   | OK           | OK       | OK               | OK          |
| 3       | Multi-Step Reference 1<br>Switches between main speed and auxiliary speed when parameter H3-05 is set to 0 (auxiliary frequency reference). | OK           | OK       | OK               | OK          |
| 4       | Multi-Step Reference 2  | OK           | OK       | OK               | OK          |
| 5       | Multi-Step Reference 3  | OK           | OK       | OK               | OK          |
| 6       | Jog Frequency Reference (higher priority than multi-step)   | OK           | OK       | OK               | OK          |
| 7       | Multi-Accel/Decel 1 (accel/decel time selector 1)   | OK           | OK       | OK               | OK          |
| 8       | External Baseblock N.O. (normally open contact)   | OK           | OK       | OK               | OK          |
| 9       | External Baseblock N.C. (normally closed contact)   | OK           | OK       | OK               | OK          |
| A       | Accel/Decel Ramp Hold (Pauses acceleration/deceleration.)   | OK           | OK       | OK               | OK          |
| B       | OH2 Alarm Signal (Inverter overheating warning)   | OK           | OK       | OK               | OK          |
| C       | Terminal 16 Enable (Enables the multi-function analog input.)   | OK           | OK       | OK               | OK          |
| D       | ASR Selection<br>(Disables PG feedback and switches to normal V/f control.)   | ---          | OK       | ---              | ---         |
| E       | ASR Integral Reset (Disables integral control.)   | ---          | OK       | ---              | OK          |
| F       | Not used. (Do not input this setting.)  | ---          | ---      | ---              | ---         |
| 10      | UP command (Always used with the DOWN command.)   | OK           | OK       | OK               | OK          |
| 11      | DOWN command (Always used with the UP command.)   | OK           | OK       | OK               | OK          |
| 12      | Forward Jog command (Forward jog at the speed in d1-09.)  | OK           | OK       | OK               | OK          |
| 13      | Reverse Jog command (Reverse jog at the speed in d1-09.)  | OK           | OK       | OK               | OK          |
| 14      | Fault Reset (Faults are reset when input goes OFF → ON.)  | OK           | OK       | OK               | OK          |
| 15      | Fast-Stop<br>(Emergency stop using the deceleration time in C1-09.)   | OK           | OK       | OK               | OK          |
| 16      | Motor 2 Selection<br>Selection of motor 1 or motor 2 for two-motor switching<br>(ON: Motor 2 selected)                                      | OK           | OK       | OK               | OK          |
| 18      | Timer Function Input<br>(Used with the b4 ON/OFF delay timers and timer output.)  | OK           | OK       | OK               | OK          |
| 19      | PID Disable (Disables PID control.)   | OK           | OK       | OK               | OK          |
| 1A      | Multi-Accel/Decel 2 (accel/decel time selector 2)   | OK           | OK       | OK               | OK          |
| 1B      | Program Lockout (Parameters write-protected when OFF.)  | OK           | OK       | OK               | OK          |
| 1C      | Trim Control Increase (Adds the d4-02 trim control level to the analog frequency reference.)  | OK           | OK       | OK               | OK          |
| 1D      | Trim Control Decrease (Subtracts the d4-02 trim control level from the analog frequency reference.)   | OK           | OK       | OK               | OK          |
| 1F      | Terminal 13/14 Switch (Selects terminal 14 when ON.)  | OK           | OK       | OK               | OK          |



| Setting  | Function  | Control mode |          |                  |             |
|----------|---|--------------|----------|------------------|-------------|
|          |   | V/f          | V/f w/PG | Open-loop Vector | Flux Vector |
| 20 to 2F | External Fault<br>(Any combination of the following can be set as needed.)<br>Input: Normally open or normally closed<br>Detection mode: Always or During operation only<br>Stopping method: Decel, Coast, Emergency, or Continue | OK           | OK       | OK               | OK          |
| 60       | DC Injection Activate (Performs DC braking when ON.)  | OK           | OK       | OK               | OK          |
| 61       | External search 1 (Speed search from max. frequency)  | OK           | ---      | OK               | ---         |
| 62       | External search 2 (Speed search from frequency reference)   | OK           | ---      | OK               | ---         |
| 63       | Energy-saving operation (according to b8-01 and b8-02)  | OK           | OK       | ---              | ---         |
| 64 to 66 | Not used. (Do not input this setting.)  | ---          | ---      | ---              | ---         |
| 71       | Speed Torque Control Change (Torque Control when ON.)   | ---          | ---      | ---              | OK          |
| 72       | Zero Servo Command (Zero Servo operation when ON.)  | ---          | ---      | ---              | OK          |
| 77       | ASR Gain Switch<br>ON: Use proportional gain in C5-03.<br>OFF: Calculate gain from C5-01, C5-03, and C5-07.   | ---          | ---      | ---              | OK          |

● Parameter Settings

The following table shows the setting information for multi-function inputs 1 through 6. These parameters cannot be changed during operation.

| Parameter number | Display name   | Setting range | Units | Default setting*1 | Valid access levels |             |                  |             |
|------------------|----------------|---------------|-------|-------------------|---------------------|-------------|------------------|-------------|
|                  |                |               |       |                   | V/f Control         | V/f with PG | Open Loop Vector | Flux Vector |
| H1-01            | Terminal 3 Sel | 0 to 77       | ---   | 24                | Basic or Advanced   |             |                  |             |
| H1-02            | Terminal 4 Sel | 0 to 77       | ---   | 14                | Basic or Advanced   |             |                  |             |
| H1-03            | Terminal 5 Sel | 0 to 77       | ---   | 3 (0)             | Basic or Advanced   |             |                  |             |
| H1-04            | Terminal 6 Sel | 0 to 77       | ---   | 4 (3)             | Basic or Advanced   |             |                  |             |
| H1-05            | Terminal 7 Sel | 0 to 77       | ---   | 6 (4)             | Basic or Advanced   |             |                  |             |
| H1-06            | Terminal 8 Sel | 0 to 77       | ---   | 8 (6)             | Basic or Advanced   |             |                  |             |

**Note 1.** The default settings in parentheses are the default settings when the Unit is initialized for 3-wire control.

**Note 2.** The following table shows the settings and page references for some common functions.

| Function(s)  | Setting(s)  | Page       |
|--|-------------|------------|
| 3-Wire Control (with forward/reverse rotation input)                         | 0           | 5-15       |
| Multi-step References 1 through 3 and Jog Reference                          | 3 through 6 | 5-16       |
| Multi-Accel/Decel 1 and 2 (acceleration/deceleration time selectors 1 and 2) | 7 and 1A    | 5-17       |
| Fast-Stop (Emergency stop)   | 15          | 5-18       |
| Forward and Reverse Jog commands   | 12 and 13   | 5-18       |
| Terminal 13/14 Switch  | 1F          | 5-18       |
| Timer Function Input   | 18          | 6-39       |
| Energy-saving operation  | 63          | 6-10, 6-32 |

● **Local/Remote Selection (Setting: 1)**

|     |  |
|-----|--|
| OFF | Operate with the frequency reference and run command specified in b1-01 (the frequency reference source selector) and b1-02 (the run command source selector). |
| ON  | Operate with the frequency reference and run command set at the Digital Operator.  |

- With this setting, the multi-function input selects the input method for the frequency reference and run command.
- The input method can be switched only when the Inverter is stopped.
- The Digital Operator’s LOCAL/REMOTE Key is disabled when this function has been set in a multi-function input.

● **Option/Inverter Selection (Setting: 2)**

|     |   |
|-----|---|
| OFF | The Inverter’s frequency reference is enabled.      |
| ON  | The Optional Card’s frequency reference is enabled. |

- With this setting, the multi-function input enables the frequency reference input from the Inverter itself or the one from Optional Card.
- The frequency reference input can be switched only when the Inverter is stopped.
- Be sure that b1-01 (the frequency reference source selector) has been set to 0 (Operator) or 1 (external terminal). Only the frequency reference from the Optional Card will be enabled if b1-01 is set to 3 (Option PCB).
- Setting 2 can’t be selected if the 3G3IV-PAI14B is being used and parameter F2-01 (AI-14 Input Selector) is set to 0.

● **External Baseblock N.O. (Setting: 8)**

|     |                  |
|-----|------------------|
| OFF | Normal operation |
| ON  | Baseblock        |

● **External Baseblock N.C. (Setting: 9)**

|     |                  |
|-----|------------------|
| OFF | Baseblock        |
| ON  | Normal operation |

- With either of these settings, the multi-function input controls baseblock operation.
- Baseblock is an interruption of the Inverter output. The motor coasts while the baseblock command is being input.
- The output frequency is retained internally, so the same frequency will be output again when the baseblock command is cleared. The output frequency will change in a step pattern when the output resumes, so take some safety precaution such as turning OFF the run command – especially if the baseblock command was input when the motor was operating at high speed. (When the run command is turned OFF, the internally retained output frequency is reset to zero.)

- After a baseblock command is cleared, the voltage will be restored in the voltage recovery time set in L2-04.

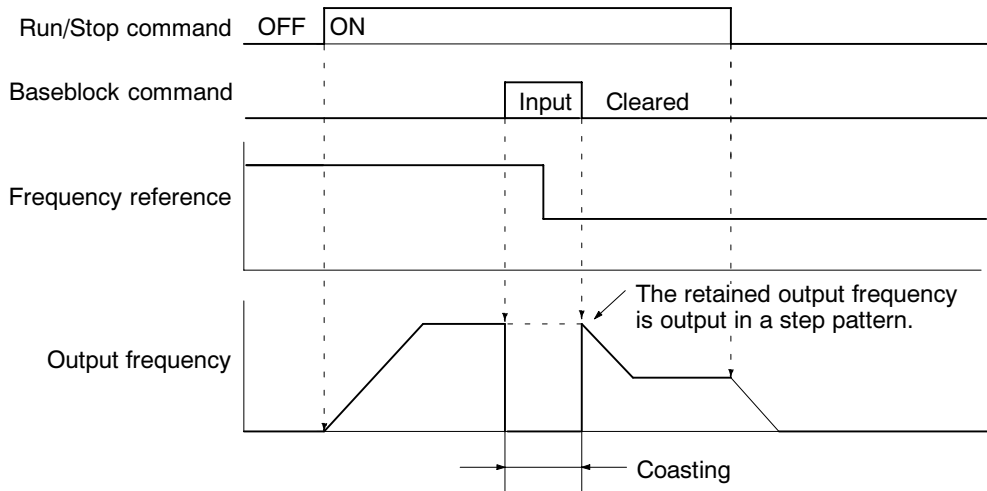

• **Acceleration/Deceleration Ramp Hold (Setting: A)**

|     |   |
|-----|---|
| OFF | Normal operation or restart acceleration/deceleration.              |
| ON  | Pause acceleration/deceleration and maintain the present frequency. |

- With this setting, the multi-function input pauses acceleration or deceleration and maintains (holds) the output frequency.
- Acceleration/deceleration is restarted when the acceleration/deceleration ramp hold input is turned OFF.
- The motor will be stopped if a stop command is input while the acceleration/deceleration ramp hold input is ON.
- When parameter d4-01 (the frequency reference hold function selector) is set to 1, the held frequency will be stored in memory. This stored frequency will be retained even after a power interruption and the motor will be restarted at this frequency when a run command is input again.

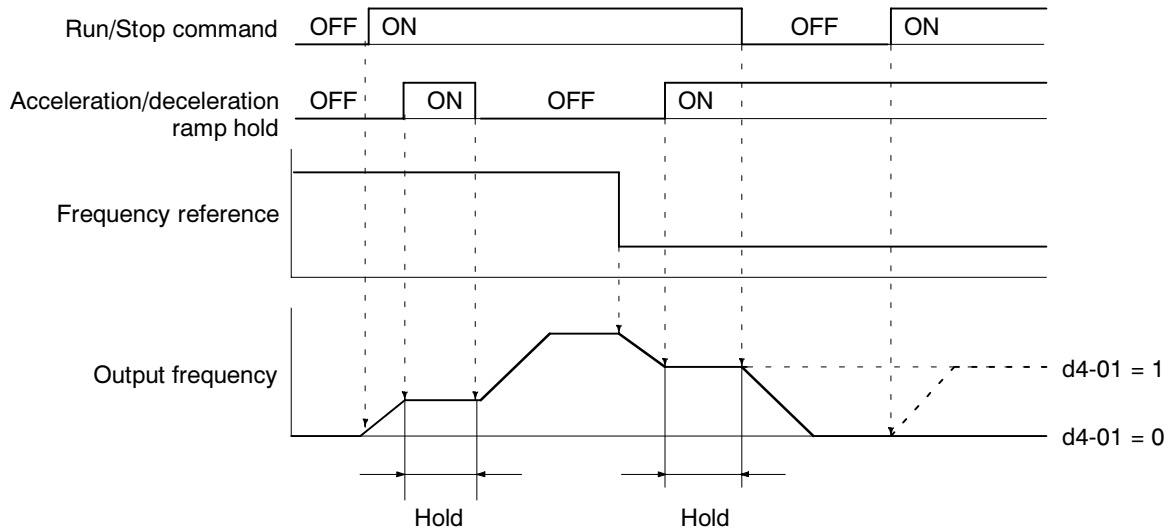

**Note 1.** When d4-01 is set to 1, the held output frequency will be retained. To operate at this frequency even after the Inverter is stopped, input the run command with the acceleration/deceleration ramp hold input ON.

**Note 2.** When d4-01 is set to 0, the output frequency will be held at zero if the run command is input with the acceleration/deceleration ramp hold input ON.

● **OH2 Alarm Signal (Setting: B)**

|     |   |
|-----|---|
| OFF | Normal operation  |
| ON  | Normal operation (The warning message “OH2” will be displayed on the Digital Operator.) |

- With this setting, a temperature sensor can be connected to the multi-function input to display a warning message when the temperature rises too high.
- The message “OH2” will be displayed on the Digital Operator while the multi-function input is ON and the display will revert to its previous status when the input is turned OFF. (It isn’t necessary to reset the alarm.)
- The Inverter will continue operation without detecting a fault.

● **Terminal 16 Enable (Setting: C)**

|     |   |
|-----|---|
| OFF | Disables the multi-function analog input (terminal 16). |
| ON  | Enables the multi-function analog input (terminal 16).  |

- With this setting, the multi-function input can be used to enable or disable the multi-function analog input.
- Turning the input OFF has the same effect as setting H3-05 (the multi-function analog input selector for terminal 16) to1F.

● **ASR Selection (Setting: D)**

|     |  |
|-----|--|
| OFF | V/f control with PG feedback (speed control with speed feedback)       |
| ON  | Normal V/f control with PG feedback (Disables speed feedback control.) |

- With this setting, the multi-function input can be used to switch “V/f control with PG feedback” to “Normal V/f control.”
- It is possible to switch between these control modes during operation.

● **ASR Integral Reset (Setting: E)**

|     |   |
|-----|---|
| OFF | Operates with PI-control speed control loop.  |
| ON  | Operates with P-control speed control loop.<br>(The speed control’s integral values are reset by the integral time constant.) |

- This function is valid only in “V/f control with PG feedback” mode when parameter F1-07 is set to 0. (Setting F1-07 to 0 disables ASR integral operation during acceleration/deceleration.)
- It is possible to switch between these speed control modes during operation.

● **UP and DOWN Commands (Settings: 10 and 11)**

| UP command | DOWN command | Operation    |
|------------|--------------|--------------|
| ON         | OFF          | Acceleration |
| OFF        | ON           | Deceleration |
| ON         | ON           | Hold         |
| OFF        | OFF          | Hold         |

- With these settings, the multi-function inputs can be used to control the Inverter's output frequency.
- When using this function, be sure to set both the UP command (setting 10) and the DOWN command (setting 11) in 2 multi-function inputs.  
(An OPE03 option fault will occur if only one of these commands is set.)
- Be sure to set parameter b1-02 (the run command source selector) to 1 (external terminal). The up/down function won't operate with any other b1-02 setting.
- The frequency up/down commands operate according to the normal acceleration/deceleration times in C1-01 through C1-08.
- The upper and lower limits for the output frequency with the up/down commands are determined by the following settings:

$$\text{Upper limit} = \text{Maximum frequency (E1-04)} \times \frac{\text{Reference upper limit (d2-01)}}{100}$$

$$\text{Lower limit} = \text{Maximum frequency (E1-04)} \times \frac{\text{Reference lower limit (d2-02)}}{100}$$

When frequency reference (voltage) terminal 13 or frequency reference (current) terminal 14 is being used as a frequency reference input, the greatest frequency value becomes the lower limit.

- When the up/down function is being used, the output frequency will be accelerated to the lower limit if a run command is input.
- When the up/down function and jog frequency reference are both assigned to multi-function inputs, an ON jog frequency reference input has the highest priority.
- Multi-step References 1 through 8 are all disabled when the up/down function has been set.
- The output frequency held by the up/down function will be stored in memory if d4-01 (the frequency reference hold function selector) is set to 1.

This output frequency will be retained even after a power interruption, and operation will be re-started at this frequency the next time that a run command is input. The stored output frequency will be cleared from memory if the UP or DOWN command is turned ON while the run command is OFF.

- The operation of the up/down function is shown in the following timing chart.

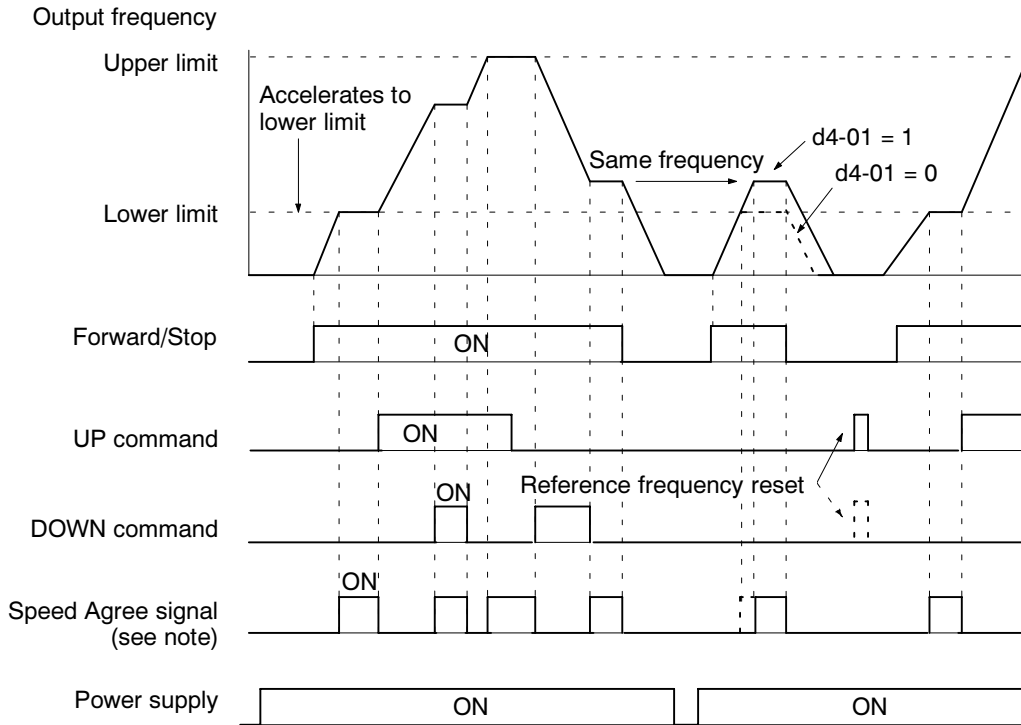

**Note** The Speed Agree signal remains ON while the run command is ON and the motor is not accelerating or decelerating.

• **Fault Reset (Setting: 14)**

|     |  |
|-----|--|
| OFF | Normal operation   |
| ON  | Resets faults when input goes from OFF to ON. (Normal operation when no fault has occurred.) |

- With this setting, the multi-function input resets faults that have occurred.
- When a fault has occurred, be sure to find out what kind of fault occurred, take steps to correct the cause of the fault, and restart the Inverter. It is possible to damage the Inverter by repeatedly resetting a fault without correcting the cause.
- To resume operation after a fault has occurred, turn the run command OFF, turn the fault reset input from ON to OFF, and then turn the run command ON again. A fault cannot be reset while the run command is ON.
- If a fault hasn't occurred, turning the fault reset ON and OFF will have no effect on operation.

• **PID Disable (Setting: 19)**

|     |   |
|-----|---|
| OFF | Enables PID control.                            |
| ON  | Disables PID control. (Normal Inverter control) |

- With this setting, the multi-function input switches between PID control and normal Inverter control.
- This function can be used to perform trial operation or jog operation with normal inverter control (open-loop control) and then switch to PID control (closed-loop control using feedback) after adjusting the system. The PID disable function can also be used to switch to open-loop control when there is a problem with the feedback value.

● **Program Lockout (Setting: 1B)**

|     |   |
|-----|---|
| OFF | Write-protects all parameters except for frequency monitor.   |
| ON  | Allows parameters specified in Initialize mode to be changed. |

- With this setting, the multi-function input can be used to write-protect the Operator’s parameters.
- When the input is OFF, the Operation mode’s frequency can be monitored and the frequency can be changed but other changes are prohibited.

● **Trim Control Increase and Decrease (Settings: 1C and 1D)**

| Trim Control Increase | Trim Control Decrease | Output frequency                                 |
|-----------------------|-----------------------|--|
| ON                    | OFF                   | Reference frequency + trim control level (d4-02) |
| OFF                   | ON                    | Reference frequency – trim control level (d4-02) |
| ON                    | ON                    | Reference frequency                              |
| OFF                   | OFF                   | Reference frequency                              |

- The trim control increase function adds the level in d4-02 to the analog frequency reference and the trim control decrease function subtracts the level in d4-02 to the analog frequency reference.
- These functions are effective when the frequency reference is input from an analog input.
- These functions can be used independently or together.
- The analog frequency reference won’t be changed when both the trim control increase and decrease inputs are ON.
- The output frequency is limited to zero when the trim control decrease input is ON and the result of the subtraction is less than zero.

● **External Faults (Settings: 20 through 2F)**

- With this setting, the multi-function input can be used to stop the Inverter or output an alarm when a malfunction or fault occurs in a peripheral device.
- There are 16 external fault inputs available with all 16 combinations of the following variables. Select the setting with the desired combination.

Input level: Normally open or normally closed  
 Detection method: Always or During operation only  
 Operation selection: Decelerate to stop, Coast to stop, Emergency stop, or Continue operation

| Setting | Input level |      | Detection method |                  | Operation selection        |                       |                        |                            |
|---------|-------------|------|------------------|------------------|----------------------------|-----------------------|------------------------|----------------------------|
|         | N.O.        | N.C. | Always           | During operation | Decelerate to stop (Fault) | Coast to stop (Fault) | Emergency stop (Fault) | Continue operation (Alarm) |
| 20      | Yes         | ---  | Yes              | ---              | Yes                        | ---                   | ---                    | ---                        |
| 21      | ---         | Yes  | Yes              | ---              | Yes                        | ---                   | ---                    | ---                        |
| 22      | Yes         | ---  | ---              | Yes              | Yes                        | ---                   | ---                    | ---                        |
| 23      | ---         | Yes  | ---              | Yes              | Yes                        | ---                   | ---                    | ---                        |
| 24      | Yes         | ---  | Yes              | ---              | ---                        | Yes                   | ---                    | ---                        |
| 25      | ---         | Yes  | Yes              | ---              | ---                        | Yes                   | ---                    | ---                        |
| 26      | Yes         | ---  | ---              | Yes              | ---                        | Yes                   | ---                    | ---                        |
| 27      | ---         | Yes  | ---              | Yes              | ---                        | Yes                   | ---                    | ---                        |
| 28      | Yes         | ---  | Yes              | ---              | ---                        | ---                   | Yes                    | ---                        |
| 29      | ---         | Yes  | Yes              | ---              | ---                        | ---                   | Yes                    | ---                        |
| 2A      | Yes         | ---  | ---              | Yes              | ---                        | ---                   | Yes                    | ---                        |
| 2B      | ---         | Yes  | ---              | Yes              | ---                        | ---                   | Yes                    | ---                        |
| 2C      | Yes         | ---  | Yes              | ---              | ---                        | ---                   | ---                    | Yes                        |
| 2D      | ---         | Yes  | Yes              | ---              | ---                        | ---                   | ---                    | Yes                        |
| 2E      | Yes         | ---  | ---              | Yes              | ---                        | ---                   | ---                    | Yes                        |
| 2F      | ---         | Yes  | ---              | Yes              | ---                        | ---                   | ---                    | Yes                        |

**Note 1.** For the input level, select whether you want a fault to be detected when the input signal is ON (normally open input) or OFF (normally closed input).

**Note 2.** For the detection method, select whether you want faults to be detected any time that the Inverter is on or only during operation.

**Note 3.** For the operation selection, select the processing method that you want to be performed when a fault has been detected.

Decelerate to stop: A fault is output and the output stopped in the selected deceleration time.

Coast to stop: A fault is output and the Inverter output is cut off.

Emergency stop: A fault is output and the output stopped in the fast-stop time (C1-09).

Continue operation: An alarm is output and operation continues.

When an alarm is going to be output externally, be sure to set one of the multi-function outputs (H2) to alarm (Minor Fault, setting 10).

- An external fault setting cannot be set in more than one multi-function input.



• Unlike other parameter settings, the external fault settings have an input procedure, as shown in the following diagrams.

1. When setting an external fault function, press the Enter Key when “External Fault” is displayed to bring up the “Input Level” display.

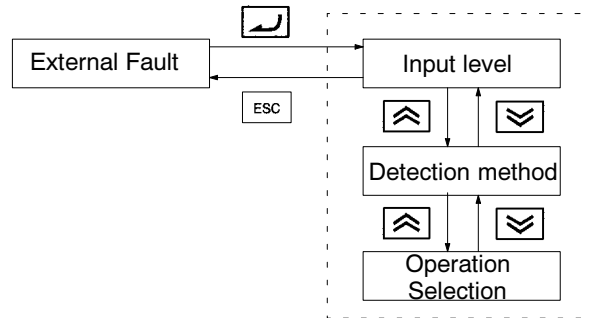

2. Press the Increment Key to switch displays as follows:  
 “Detection Method” → “Operation Selection” → “Input Method”
3. Press the Enter Key at the desired parameter to select that parameter. At this point, the Increment and Decrement Keys can be pressed to scroll through the available settings for the selected parameter. Press the Enter Key to select the displayed parameter setting.  
 (Press the Escape Key to cancel the operation without changing the parameter setting.)

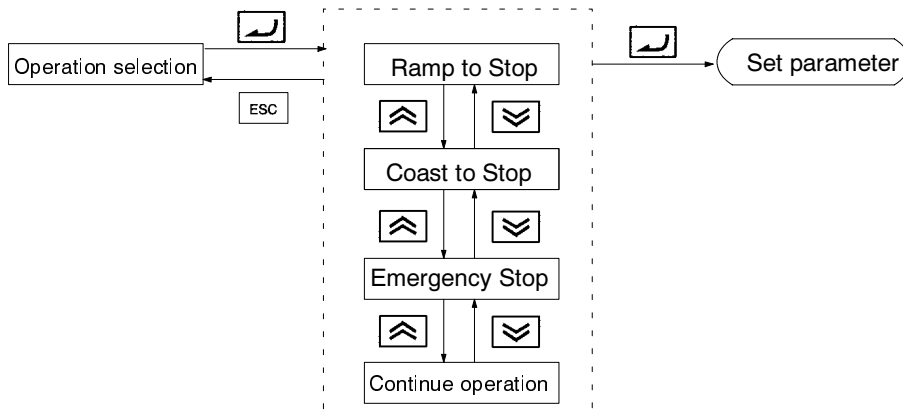
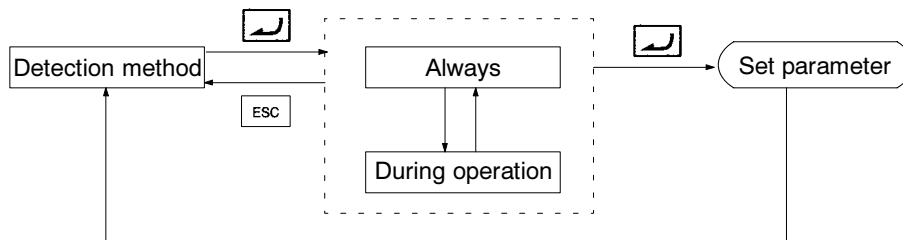
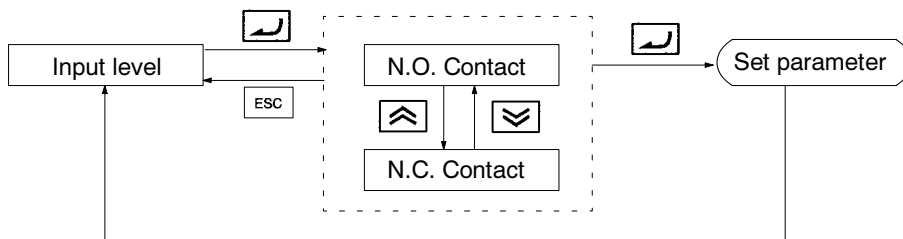

● **DC Injection Activate (Setting: 60)**

|     |  |
|-----|--|
| OFF | Normal operation   |
| ON  | Applies DC braking if the Inverter is stopped.<br>(Applies initial excitation when flux vector control is being used.) |

- DC braking is used to prevent the motor from rotating due to inertia or external forces when the Inverter is stopped.
- DC braking is performed if the DC braking input is ON while the Inverter is stopped.
- If a run command or jog command (jog frequency reference, forward jog, or reverse jog) is input, the DC braking will be cleared and motor operation will be started.

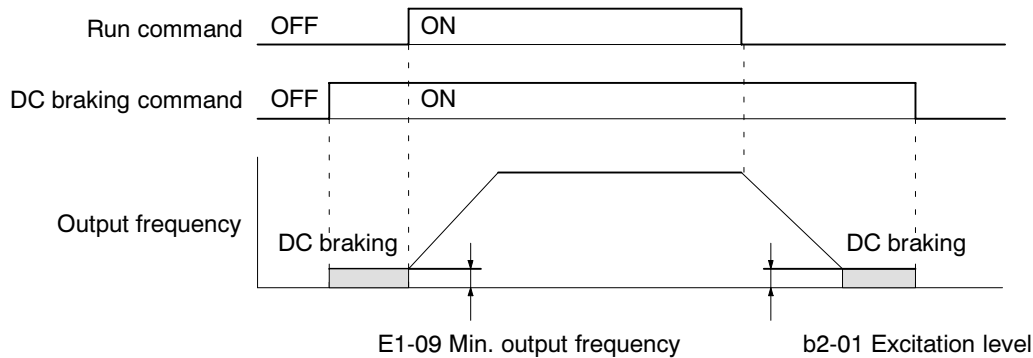

● **External Search 1 (Settings: 61)**

|     |   |
|-----|---|
| OFF | Normal operation                                  |
| ON  | Starts a speed search from the maximum frequency. |

● **External Search 2 (Settings: 62)**

|     |   |
|-----|---|
| OFF | Normal operation  |
| ON  | Starts a speed search from the set frequency (the present reference frequency). |

- The speed search function can be used to operate the motor without tripping when switching operation from a commercial power supply and the Inverter or starting a coasting motor.
- The speed search will begin after the minimum baseblock time has elapsed when the run command is input after the external search command has been turned ON.
- Either one of the external search functions can be set, but not both.

Timing Chart

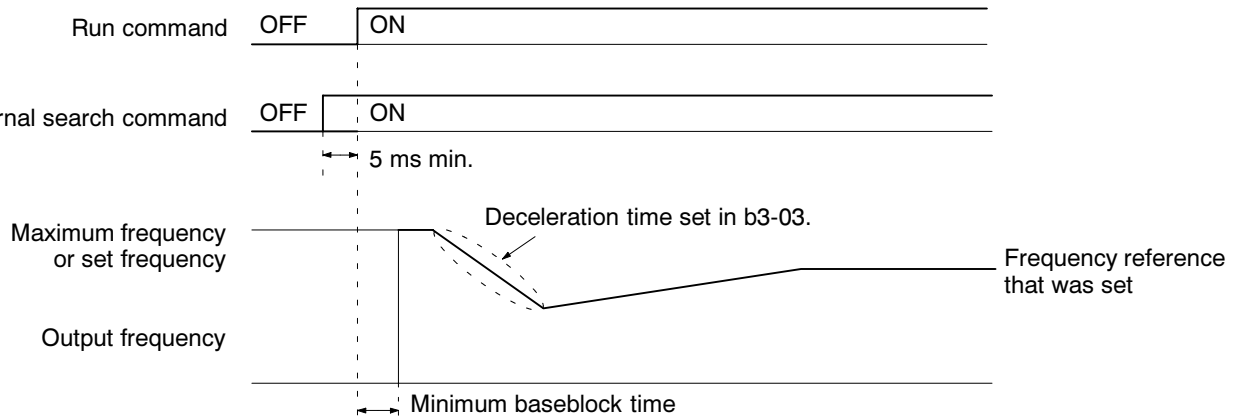

• Speed Torque Control Change (Setting: 71)

|     |                |
|-----|----------------|
| OFF | Speed control  |
| ON  | Torque control |

- With this setting, the multi-function input can be used to switch between speed and torque control.

**Note** Refer to 6-3-5 Speed/Torque Control Switching Function for more details.

• Zero-servo Command (Setting: 72)

|     |  |
|-----|--|
| OFF | Normal operation   |
| ON  | Locks position when the frequency (speed) reference falls below the zero-speed level in b2-01. |

- With this setting, the multi-function input controls the zero servo function (B9-01 and b9-02).
- When the zero-servo command is ON, a position control loop is formed and the motor is completely stopped when the frequency (speed) reference falls below the excitation level set in b2-01.

**Note** Refer to 6-3-3 Zero-servo Function (Position-lock) for more details.

• ASR Gain Switch (Setting: 77)

|     |   |
|-----|---|
| OFF | The gain is set according to the values in C5-01, C5-03, and C5-07. |
| ON  | The gain is set to the value in C5-03 (ASR proportional gain 2).    |

- With this setting, the multi-function input switches the proportional gain used in speed control (ASR). (The integral time is not changed.)

**Note** Refer to 5-4-4 Speed Loop (ASR) Structure for more details on parameters C5-01, C5-03, and C5-07.

■ Multi-function Output Settings (H2)

| Setting | Function   | Control mode |          |                  |             |
|---------|--|--------------|----------|------------------|-------------|
|         |  | V/f          | V/f w/PG | Open-loop Vector | Flux Vector |
| 0       | During RUN 1   | OK           | OK       | OK               | OK          |
| 1       | Zero-speed   | OK           | OK       | OK               | OK          |
| 2       | Fref/Fout Agree 1 (Detection width in L4-02)   | OK           | OK       | OK               | OK          |
| 3       | Fref/Set Agree 1 (Detection width in L4-02)  | OK           | OK       | OK               | OK          |
| 4       | Frequency Detection 1 ( $-L4-01 \geq \text{output frequency} \geq +L4-01$ )  | OK           | OK       | OK               | OK          |
| 5       | Frequency Detection 2 ( $ \text{Output frequency}  \geq L4-01$ )   | OK           | OK       | OK               | OK          |
| 6       | Inverter Ready (Initialization completed, no faults)   | OK           | OK       | OK               | OK          |
| 7       | DC Bus Undervoltage (Main circuit voltage too low)   | OK           | OK       | OK               | OK          |
| 8       | Baseblock 1  | OK           | OK       | OK               | OK          |
| 9       | Option Reference (ON: Frequency reference from Operator)   | OK           | OK       | OK               | OK          |
| A       | Remote Operation (ON: Run command from Operator)   | OK           | OK       | OK               | OK          |
| B       | Torque Detection 1 (N.O.)  | OK           | OK       | OK               | OK          |
| C       | Loss of Reference (Valid when L4-05 is set to 1.)  | OK           | OK       | OK               | OK          |
| D       | DB overheat (DC braking resistor overheating or faulty)  | OK           | OK       | OK               | OK          |
| E       | Fault (A fault other than CPF00 or CPF01 occurred.)  | OK           | OK       | OK               | OK          |
| 10      | Minor Fault (Alarm display)  | OK           | OK       | OK               | OK          |
| 11      | Reset Command Active (Fault reset command in progress)   | OK           | OK       | OK               | OK          |
| 12      | Timer Output   | OK           | OK       | OK               | OK          |
| 13      | Fref/Fout Agree 2 (Detection width in L4-04)   | OK           | OK       | OK               | OK          |
| 14      | Fref/Set Agree 2 (Detection width in L4-04)  | OK           | OK       | OK               | OK          |
| 15      | Frequency Detection 3 ( $\text{Output frequency} \leq -L4-03$ )  | OK           | OK       | OK               | OK          |
| 16      | Frequency Detection 4 ( $\text{Output frequency} \geq -L4-03$ )  | OK           | OK       | OK               | OK          |
| 17      | Torque Detection 1 (N.C.)  | OK           | OK       | OK               | OK          |
| 18      | Torque Detection 2 (N.O.)  | OK           | OK       | OK               | OK          |
| 19      | Torque Detection 2 (N.C.)  | OK           | OK       | OK               | OK          |
| 1A      | Reverse Direction (Operating in reverse direction.)  | OK           | OK       | OK               | OK          |
| 1B      | Baseblock 2  | OK           | OK       | OK               | OK          |
| 1C      | Motor 2 Selected (ON: Motor 2 selected)  | OK           | OK       | OK               | OK          |
| 1D      | Regenerating   | ---          | ---      | ---              | OK          |
| 1E      | Restart Enabled (Enabled during restart by Auto Restart operation) (ON: During restart)                                    | OK           | OK       | OK               | OK          |
| 1F      | Overload (OL1) (ON when 90% or more than detection level)  | OK           | OK       | OK               | OK          |
| 20      | OH Prealarm (ON when temperature exceeds L8-02 setting)  | OK           | OK       | OK               | OK          |
| 30      | Current/Torque Limit   | ---          | ---      | OK               | OK          |
| 31      | Speed Limit  | ---          | ---      | ---              | OK          |
| 33      | Zero Servo End (Zero servo function completed)   | ---          | ---      | ---              | OK          |
| 37      | During RUN 2<br>(ON when outputting a frequency. OFF for baseblock, DC braking, initial excitation, or stopped operation.) | OK           | OK       | OK               | OK          |

● **Parameter Settings**

The following table shows the setting information for the multi-function outputs. These parameters cannot be changed during operation.

| Parameter number | Display name    | Setting range | Units | Default setting*1 | Valid access levels |             |                  |             |
|------------------|-----------------|---------------|-------|-------------------|---------------------|-------------|------------------|-------------|
|                  |                 |               |       |                   | V/f Control         | V/f with PG | Open Loop Vector | Flux Vector |
| H2-01            | Terminal 9 Sel  | 0 to 37       | ---   | 0                 | Basic or Advanced   |             |                  |             |
| H2-02            | Terminal 25 Sel | 0 to 37       | ---   | 1                 | Basic or Advanced   |             |                  |             |
| H2-03            | Terminal 26 Sel | 0 to 37       | ---   | 2                 | Basic or Advanced   |             |                  |             |

**Note 1.** The following table shows the settings and page references for functions that are described in more detail in this chapter.

| Function                  | Setting | Page |
|---------------------------|---------|------|
| Fref/Fout Agree 1         | 2       | 6-84 |
| Fref/Set Agree 1          | 3       | 6-84 |
| Frequency Detection 1     | 4       | 6-84 |
| Frequency Detection 2     | 5       | 6-84 |
| Torque Detection 1 (N.O.) | B       | 6-88 |
| Loss of Reference         | C       | 6-84 |
| Timer Output              | 12      | 6-39 |
| Fref/Fout Agree 2         | 13      | 6-84 |
| Fref/Set Agree 2          | 14      | 6-84 |
| Frequency Detection 3     | 15      | 6-84 |
| Frequency Detection 4     | 16      | 6-84 |
| Torque Detection 1 (N.C.) | 17      | 6-88 |
| Torque Detection 2 (N.O.) | 18      | 6-88 |
| Torque Detection 2 (N.C.) | 19      | 6-88 |

**Note 2.** The following table shows the settings for simple functions that aren't explained in detail.

| Function             | Setting |
|----------------------|---------|
| Inverter Ready       | 6       |
| DC Bus Undervoltage  | 7       |
| Baseblock 1          | 8       |
| Option Reference     | 9       |
| Remote Operation     | A       |
| DB overheat          | D       |
| Fault                | E       |
| Minor Fault          | 10      |
| Reset Command Active | 11      |
| Reverse Direction    | 1A      |
| Baseblock 2          | 1B      |
| Motor 2 Selected     | 1D      |
| Regenerating         | 1E      |
| Current/Torque Limit | 30      |
| Speed Limit          | 31      |

● **Inverter Operating 1 (“During RUN 1,” Setting: 0)**

|     |   |
|-----|---|
| OFF | The run command is OFF and there is not output voltage. |
| ON  | The run command is ON and voltage is being output.      |

● **Inverter Operating 2 (“During RUN 2,” Setting: 37)**

|     |   |
|-----|---|
| OFF | The Inverter is not outputting a frequency. (Baseblock, DC braking, initial excitation, or stopped) |
| ON  | The Inverter is outputting a frequency.   |

• These outputs can be used to indicate the Inverter’s operating status.

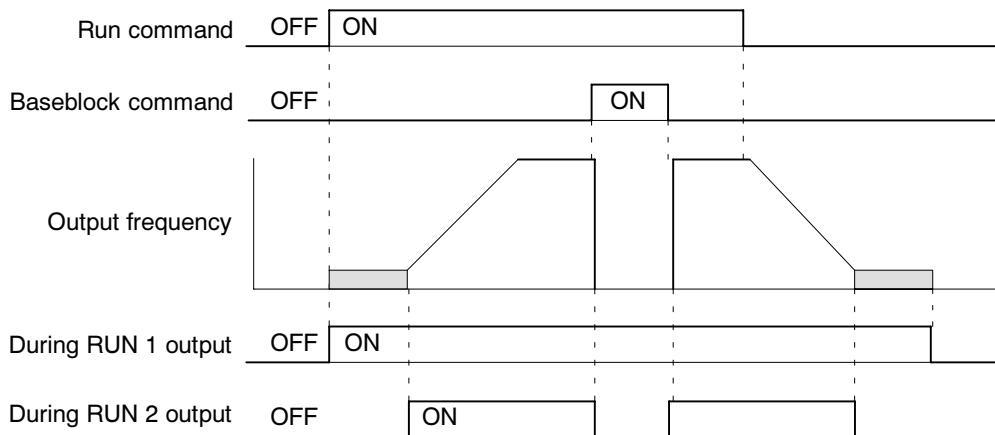

● **Excitation (Setting: 1)**

|     |   |
|-----|---|
| OFF | The output frequency is greater than the minimum output frequency (E1-09). (With flux vector control, the output frequency is greater than the excitation level (b2-01).) |
| ON  | The output frequency is less than the minimum output frequency (E1-09). (With flux vector control, the output frequency is less than the excitation level (b2-01).)       |

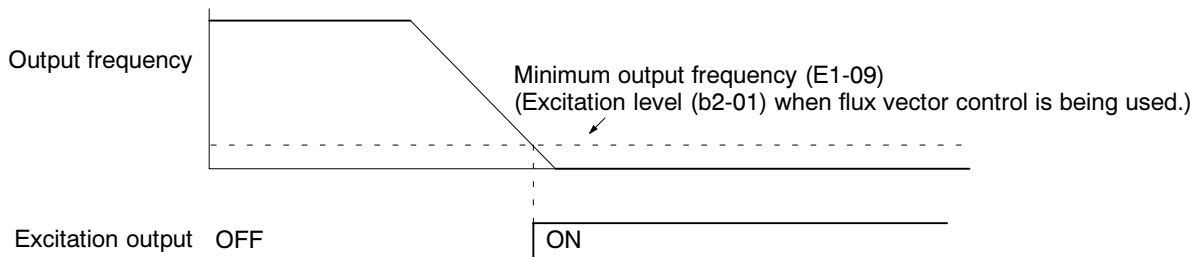

● **Overload OL1 (Setting: 1F)**

|     |  |
|-----|--|
| OFF | The motor protection function’s electronic thermal value is less than 90% of the detection level.    |
| ON  | The motor protection function’s electronic thermal value is greater than 90% of the detection level. |

- This output function is valid when the motor overload protection function is enabled (L1-01 =1).
- This output can be used to warn of overheating before the protection function itself operates.

● **OH Prealarm (Setting: 20)**

|     |   |
|-----|---|
| OFF | The cooling fin temperature is less than the “OH Pre-Alarm Level” set in L8-02. |
| ON  | The cooling fin temperature exceeds the “OH Pre-Alarm Level” set in L8-02.      |

- This output function indicates that the temperature of the cooling fins reaches the temperature set in L8-02 (the Inverter overheating alarm detection level).

● Zero-servo End (Setting: 33)

|     |  |
|-----|--|
| OFF | The zero-servo command isn't being input or zero-servo position control hasn't been completed.                       |
| ON  | The position has been brought within the zero servo completion width (b9-02) after the zero servo command was input. |

- This output function indicates that zero-servo position control has been completed.
- The output is turned ON after the zero servo command is input and the difference between the zero-servo operation starting position and the current position is within the zero servo completion width (b9-02).

■ Multi-function Analog Input/Frequency Reference (Current) (H3-05/H3-09)

● Parameter Settings

| Parameter number | Display name    | Setting range | Units | Default setting | Valid access levels |             |                  |             |
|------------------|-----------------|---------------|-------|-----------------|---------------------|-------------|------------------|-------------|
|                  |                 |               |       |                 | V/f Control         | V/f with PG | Open Loop Vector | Flux Vector |
| H3-05            | Terminal 16 Sel | 0 to 1F       | ---   | 1F              | Basic or Advanced   |             |                  |             |
| H3-09            | Terminal 14 Sel | 1 to 1F       | ---   | 1F              | Advanced            |             |                  |             |

**Note** These parameters cannot be changed during operation.

| Setting | Function                     | Equivalent of 100% Input (10 V or 20 mA)                               | Control mode |          |                  |             |
|---------|------------------------------|--|--------------|----------|------------------|-------------|
|         |                              |  | V/f          | V/f w/PG | Open-loop Vector | Flux Vector |
| 0       | Auxiliary reference (H3-05)  | Maximum frequency  | OK           | OK       | OK               | OK          |
| 1       | Frequency Gain               | Frequency ref. of terminal 13  | OK           | OK       | OK               | OK          |
| 2       | Frequency Bias               | Maximum frequency (added to H3-03)                                     | OK           | OK       | OK               | OK          |
| 4       | Voltage Bias                 | Rated voltage (E1-05)  | OK           | OK       | OK               | OK          |
| 5       | Accel/Decel Change           | Accel/Decel times (C1-□□)  | OK           | OK       | OK               | ---         |
| 6       | DC Brake Current             | Inverter's rated output current  | OK           | OK       | OK               | OK          |
| 7       | Overtorque Level             | Rated torque or Inverter's rated output (Setting in L6-05 is ignored.) | OK           | OK       | ---              | ---         |
| 8       | Stall Prevention Level       | Inverter's rated output current  | OK           | OK       | OK               | OK          |
| 9       | Reference Lower Limit        | Maximum frequency  | OK           | OK       | OK               | OK          |
| A       | Jump Frequency               | Maximum frequency  | OK           | OK       | OK               | OK          |
| B       | PID Feedback                 | Maximum frequency  | OK           | OK       | OK               | OK          |
| 10      | Forward Torque Limit         | Rated torque   | ---          | ---      | OK               | OK          |
| 11      | Reverse Torque Limit         | Rated torque   | ---          | ---      | OK               | OK          |
| 12      | Regenerative Torque Limit    | Rated torque   | ---          | ---      | OK               | OK          |
| 13      | Torque reference             | Rated torque   | ---          | ---      | ---              | OK          |
| 14      | Torque Compensation Bias     | Rated torque   | ---          | ---      | ---              | OK          |
| 15      | Speed Limit                  | Rated torque   | ---          | ---      | OK               | OK          |
| 1F      | Disable analog input (H3-05) | ---  | OK           | OK       | OK               | OK          |
|         | Frequency Reference (H3-09)  | Maximum frequency  |              |          |                  |             |

**Note 1.** The analog inputs' signal level, gain, and bias are set with the following parameters. Terminal 16 is the multi-function analog input and terminal 14 is the frequency reference (current) input.

- Terminal 16 signal level selector ... H3-04 (0 to +10 V or 0 to ±10 V)
- Terminal 16 input gain ..... H3-06
- Terminal 16 input bias ..... H3-07
- Terminal 14 signal level selector ... H3-08 (0 to +10 V, 0 to ±10 V, or 4 to 20 mA)
- Terminal 14 input gain ..... H3-10
- Terminal 14 input bias ..... H3-11

**Note 2.** When a voltage input is being input to terminal 14, be sure to disconnect jumper wire J1 on the control board. The input resistance will be destroyed if a voltage input is used without disconnecting the jumper wire.

**Note 3.** Set the time constant with the following parameter when adding a primary delay filter to an analog input:

- Analog input filter time constant ... H3-12
- This filter time constant applies to all three of the analog inputs.

● **Analog Input Characteristics with Gain = 100.0% and Bias = 0.0%**

- Auxiliary Frequency Reference (Setting: 0)
  - Frequency Bias (Setting: 2)
  - PID Feedback (Setting: B)

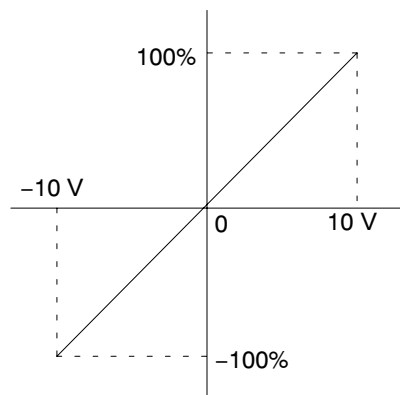

- Frequency Gain (Setting: 1)
  - Output Voltage Bias (Setting: 4)
  - DC Braking Current (Setting: 6)
  - Overtorque Detection Level (Setting: 7)

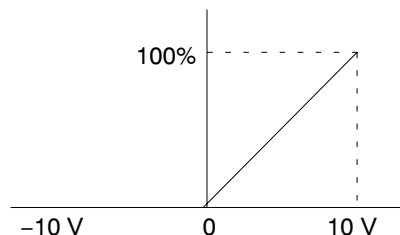



- Acceleration/Deceleration Time Gain (Setting: 5)

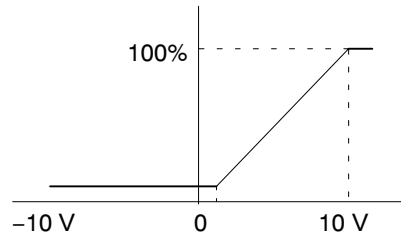

- Stall Prevention Level (Setting: 8)

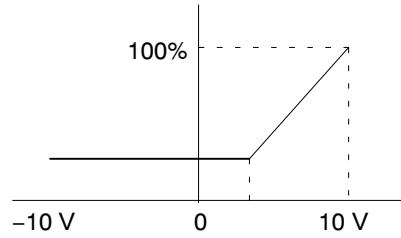

- Output Frequency Lower Limit (Setting: 9)  
Jump Frequency (Setting: A)

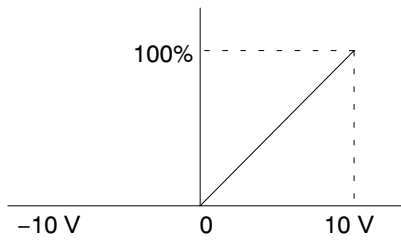

- Torque Reference (Setting: 13)  
Torque Compensation Bias (Setting: 14)

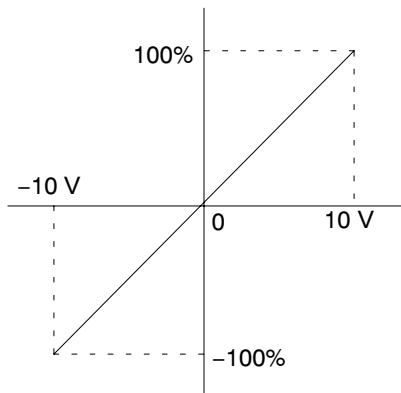

- Forward Torque Limit (Setting: 10)  
Reverse Torque Limit (Setting: 11)  
Regenerative Torque Limit (Setting: 12)

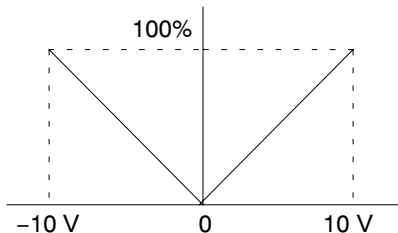

- Forward/Reverse Torque (Speed) Limit (Setting: 15)

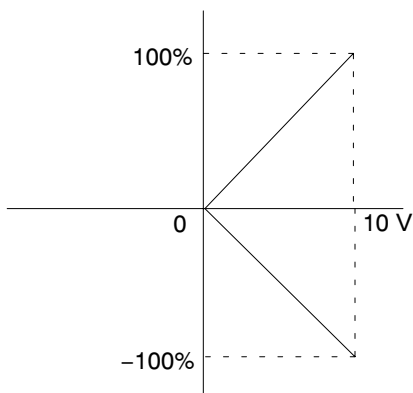

### Multi-function Analog Output Settings (H4)

#### Function Selection Parameters

| Parameter number | Display name    | Setting range <sup>1,2</sup> | Units | Default setting | Valid access levels |             |                  |             |
|------------------|-----------------|------------------------------|-------|-----------------|---------------------|-------------|------------------|-------------|
|                  |                 |                              |       |                 | V/f Control         | V/f with PG | Open Loop Vector | Flux Vector |
| H4-01            | Terminal 21 Sel | 1 to 31                      | ---   | 2               | Basic or Advanced   |             |                  |             |
| H4-04            | Terminal 23 Sel | 1 to 31                      | ---   | 3               | Basic or Advanced   |             |                  |             |

**Note** These parameters cannot be changed during operation.

- The multi-function outputs can be set to monitor any of the U1 Inverter status items by setting the last two digits of the parameter number (U1-□□). Refer to page 3-12 for a table listing all of these U1 settings.
- Settings 4, 10, 11, 12, 13, 14, 25, and 28 can't be set and settings 29, 30, and 31 aren't used.

#### Adjusting the Monitor Output

| Parameter number | Display name     | Setting range | Units  | Default setting | Valid access levels |             |                  |             |
|------------------|------------------|---------------|--------|-----------------|---------------------|-------------|------------------|-------------|
|                  |                  |               |        |                 | V/f Control         | V/f with PG | Open Loop Vector | Flux Vector |
| H4-02            | Terminal 21 Gain | 0.00 to 2.50  | Factor | 1.00            | Basic or Advanced   |             |                  |             |
| H4-03            | Terminal 21 Bias | -10.0 to 10.0 | %      | 0.0             | Basic or Advanced   |             |                  |             |
| H4-05            | Terminal 23 Gain | 0.00 to 2.50  | Factor | 0.50            | Basic or Advanced   |             |                  |             |
| H4-06            | Terminal 23 Bias | -10.0 to 10.0 | %      | 0.0             | Basic or Advanced   |             |                  |             |

**Note** These parameters can be changed during operation.

- For the output gain, set what multiple of 10 V will correspond to a 100% output of the monitored item.
- For the output bias, set the amount that the output characteristic will be shifted vertically. Set this amount as a percentage, with 10 V corresponding to 100%.

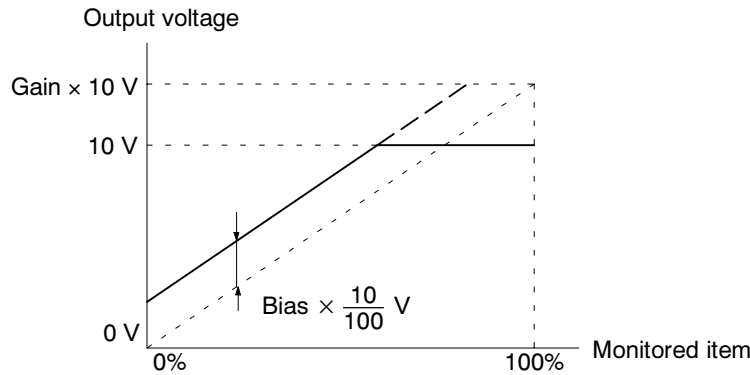

• **Multi-function Analog Output Signal Level**

| Parameter number | Display name    | Setting range | Units | Default setting | Valid access levels |             |                  |             |
|------------------|-----------------|---------------|-------|-----------------|---------------------|-------------|------------------|-------------|
|                  |                 |               |       |                 | V/f Control         | V/f with PG | Open Loop Vector | Flux Vector |
| H4-07            | AO Level Select | 0 or 1        | ---   | 0               | Basic or Advanced   |             |                  |             |

**Note** This parameter cannot be changed during operation.

| Setting | Function                           |
|---------|------------------------------------|
| 0       | 0 to +10 V (Absolute value output) |
| 1       | 0 to ±10 V                         |

- This signal level setting applies to analog outputs 1 and 2 (terminals 21 and 23).
- When the 0- to ±10-V signal level is used to output speed values (frequency reference, output frequency, or motor speed), positive voltage indicates Inverter output in the forward direction and negative voltage indicates Inverter output in the reverse direction. (Assuming a bias setting of 0.0.)
- There are some monitor items that are limited to the 0 to +10 V signal range even when the 0- to ±10-V signal level has been selected. Refer to the table of status monitor items in page 3-12 for details.

**6-5-7 Protective Functions: L**

■ **Motor Protection Settings (L1)**

| Parameter number | Display name     | Setting range | Units | Default setting | Valid access levels |             |                  |             |
|------------------|------------------|---------------|-------|-----------------|---------------------|-------------|------------------|-------------|
|                  |                  |               |       |                 | V/f Control         | V/f with PG | Open Loop Vector | Flux Vector |
| L1-01            | MOL Fault Select | 0 or 1        | ---   | 1               | Basic or Advanced   |             |                  |             |

**Note** This parameter cannot be changed during operation.

| Setting | Function  |
|---------|-----------|
| 0       | Disabled. |
| 1       | Enabled.  |

- This setting enables or disables the motor overload protection function.
- The rated current setting (E2-01) is used as a basis for overload detection.
- Disable the motor protection function (setting 0) when two or more motors are connected to a single Inverter. Use another method to provide overload protection separately to each motor, such as connecting a thermal relay to the power line of each motor.
- The motor protection function may not protect a motor when the power supply is turned on and off frequently, because the thermal value is reset each time that the power is turned off.
- If the Overload OL1 alarm (1F) is set in one of the multi-function outputs (H2-01 through H2-03), the output will be turned ON when the electronic thermal value reaches 90% of the overload detection level.

| Parameter number | Display name   | Setting range | Units   | Default setting | Valid access levels |             |                  |             |
|------------------|----------------|---------------|---------|-----------------|---------------------|-------------|------------------|-------------|
|                  |                |               |         |                 | V/f Control         | V/f with PG | Open Loop Vector | Flux Vector |
| L1-02            | MOL Time Const | 0.1 to 5.0    | Minutes | 1.0             | Basic or Advanced   |             |                  |             |

**Note** This parameter cannot be changed during operation.

- Normally it isn't necessary to change this setting. (The default setting is a 150%, 1 minute endurance.)
- This setting specifies the electronic thermal detection time.
- When the motor's overload endurance level is known, set the hot-start overload resistance level for the motor, but be sure to allow some margin for safety.
- Decrease this setting when you want to detect an overload more quickly.

**Electronic Thermal Time Characteristics**

In this example, L1-02 is set to 1 minute, the motor is operating at 60 Hz, and general-purpose motor characteristics are used.

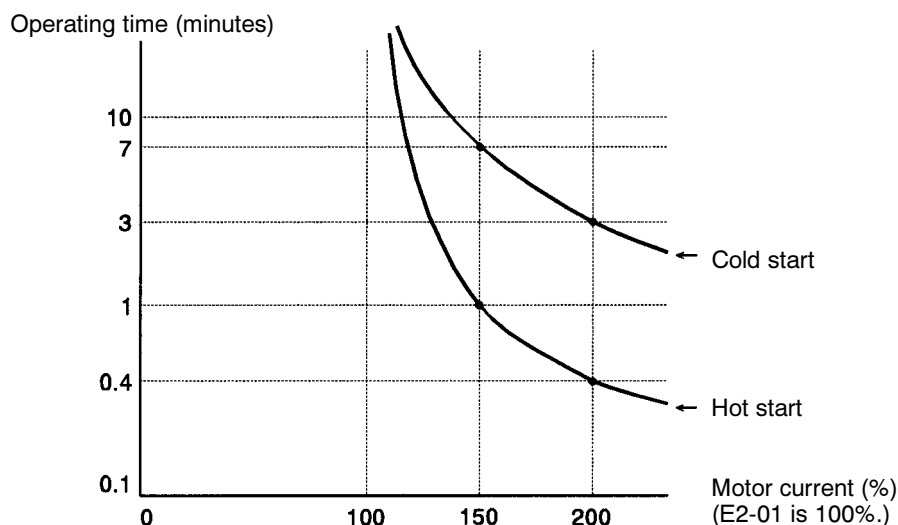

■ **Momentary Power Loss Settings (L2)**

| Parameter number | Display name   | Setting range | Units | Default setting | Valid access levels |             |                  |             |
|------------------|----------------|---------------|-------|-----------------|---------------------|-------------|------------------|-------------|
|                  |                |               |       |                 | V/f Control         | V/f with PG | Open Loop Vector | Flux Vector |
| L2-01            | PwrL Selection | 0 to 2        | ---   | 0               | Basic or Advanced   |             |                  |             |

**Note** This parameter cannot be changed during operation.

| Setting | Function  |
|---------|---|
| 0       | Disabled. (An under-voltage fault is detected when there is a momentary power loss.)  |
| 1       | Enabled. (Restarts if power is restored within the L2-02 time. An under-voltage fault is detected for a longer power loss.)       |
| 2       | Enabled during CPU operation. (Restarts if power is restored while the CPU is operating. An under-voltage fault is not detected.) |

- This parameter specifies the processing that is performed when a momentary power loss occurs.
- When power-loss ridethrough is enabled (setting 1 or 2), operation will be restarted after a speed search if the power is restored within the allowed time interval.
- When power-loss ridethrough is disabled (setting 0), an under-voltage fault will be detected if power is interrupted for more than 15 ms.

| Parameter number | Display name    | Setting range | Units | Default setting*2 | Valid access levels |             |                  |             |
|------------------|-----------------|---------------|-------|-------------------|---------------------|-------------|------------------|-------------|
|                  |                 |               |       |                   | V/f Control         | V/f with PG | Open Loop Vector | Flux Vector |
| L2-02            | PwrL Ridethru t | 0.0 to 2.0    | s     | 0.7               | Basic or Advanced   |             |                  |             |

**Note 1.** This parameter cannot be changed during operation.

**Note 2.** The default setting depends on the Inverter’s capacity. The default setting shown in the table is for a 200-V class, 0.4-kW Inverter.

- This setting is valid only when parameter L2-01 is set to 1.
- Set the power-loss ridethrough time in seconds.

| Parameter number | Display name     | Setting range | Units | Default setting*2 | Valid access levels |             |                  |             |
|------------------|------------------|---------------|-------|-------------------|---------------------|-------------|------------------|-------------|
|                  |                  |               |       |                   | V/f Control         | V/f with PG | Open Loop Vector | Flux Vector |
| L2-03            | PwrL Baseblock t | 0.0 to 5.0    | s     | 0.5               | Basic or Advanced   |             |                  |             |

**Note 1.** This parameter cannot be changed during operation.

**Note 2.** The default setting depends on the Inverter’s capacity. The default setting shown in the table is for a 200-V class, 0.4-kW Inverter.

- This setting is used with the speed search and DC braking functions.
- Set the time required for the leakage voltage to dissipate. Increase the setting if an overcurrent (OC) occurs when the speed search or DC braking function starts.
- This setting is valid for speed searches performed after a momentary power loss and regular speed searches.

| Parameter number | Display name    | Setting range | Units | Default setting | Valid access levels |             |                  |             |
|------------------|-----------------|---------------|-------|-----------------|---------------------|-------------|------------------|-------------|
|                  |                 |               |       |                 | V/f Control         | V/f with PG | Open Loop Vector | Flux Vector |
| L2-04            | PwrL V/F Ramp t | 0.0 to 2.0    | s     | 0.3             | Advanced            |             |                  |             |

**Note** This parameter cannot be changed during operation.

- Set the time allowed for the normal voltage to be restored after completion of the speed search.
- For a 200-V class Inverter, this is the time in seconds for voltage to be restored from 0 VAC to 200 VAC. For a 400-V class Inverter, this is the time in seconds for voltage to be restored from 0 VAC to 400 VAC.
- This setting is valid for speed searches after a momentary power loss, regular speed searches, the voltage changes with energy-saving control, and the voltage changes with baseblock clearing.

| Parameter number | Display name  | Setting range              | Units | Default setting | Valid access levels |             |                  |             |
|------------------|---------------|----------------------------|-------|-----------------|---------------------|-------------|------------------|-------------|
|                  |               |                            |       |                 | V/f Control         | V/f with PG | Open Loop Vector | Flux Vector |
| L2-05            | PUV Det Level | 150 to 210<br>(300 to 420) | V     | 190 (380)       | Advanced            |             |                  |             |

**Note 1.** This parameter cannot be changed during operation.

**Note 2.** The values in parentheses are for 400-V class Inverters.

- Normally it isn't necessary to change this setting.
- Use this parameter when you want to add an AC reactor and lower the main circuit under-voltage detection level. Be sure to set a main circuit DC voltage value (V) that will detect a main circuit under-voltage.

### ■ Stall Prevention Function Settings (L3)

A stall occurs if the rotor cannot keep up with the rotating magnetic field on the motor stator side when a large load is applied to the motor or a sudden acceleration/deceleration is performed.

In the 3G3FV, stall prevention functions can be set independently for accelerating, running, and decelerating. (Some functions are restricted depending on the control mode.)

| Parameter number | Display name     | Setting range | Units | Default setting | Valid access levels*2 |             |                  |             |
|------------------|------------------|---------------|-------|-----------------|-----------------------|-------------|------------------|-------------|
|                  |                  |               |       |                 | V/f Control           | V/f with PG | Open Loop Vector | Flux Vector |
| L3-01            | StallP Accel Sel | 0 to 2        | ---   | 1               | Basic or Advanced     |             |                  | N.A.        |

**Note 1.** This parameter cannot be changed during operation.

**Note 2.** N.A. = Not applicable.

| Setting | Function   |
|---------|--|
| 0       | Disabled. (Accelerate according to the settings. Stalls may occur with large loads.)                               |
| 1       | Enabled. (Stop acceleration if L3-02 setting is exceeded. Accelerate again when current recovers.)                 |
| 2       | Intelligent. (Adjust acceleration so that the L3-02 isn't exceeded by much. Ignore the acceleration time setting.) |

- When setting 1 (enabled) is selected, acceleration is stopped if the motor current exceeds the acceleration stall prevention level. Acceleration is started again when the current falls below this level.
- When setting 2 (intelligent) is selected, acceleration is performed using the the acceleration stall prevention level as a basis. In this case, the acceleration time is ignored.

| Parameter number | Display name     | Setting range | Units | Default setting | Valid access levels*2 |             |                  |             |
|------------------|------------------|---------------|-------|-----------------|-----------------------|-------------|------------------|-------------|
|                  |                  |               |       |                 | V/f Control           | V/f with PG | Open Loop Vector | Flux Vector |
| L3-02            | StallP Accel Lvl | 0 to 200      | %     | 150             | Basic or Advanced     |             |                  | N.A.        |

**Note 1.** This parameter cannot be changed during operation.

**Note 2.** N.A. = Not applicable.

- This setting is valid when L3-01 is set to 1 or 2.

- Normally it isn't necessary to change this setting.
- Decrease this setting when the motor's capacity is small compared to the Inverter's capacity or stalling occurs when the motor is operated with the default setting. The standard target setting is 2 to 3 times the motor's rated current. (Set this current value as a percentage of the Inverter's rated current, i.e., 100% corresponds to the Inverter's rated current.)

**Acceleration Stall Prevention Example: L3-01 = 1**

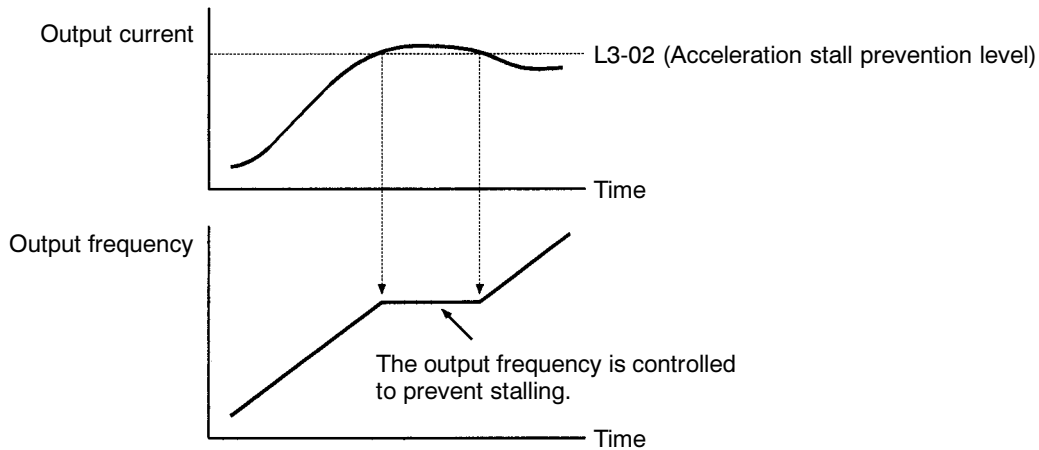

| Parameter number | Display name   | Setting range | Units | Default setting*2 | Valid access levels*3 |             |                  |             |
|------------------|----------------|---------------|-------|-------------------|-----------------------|-------------|------------------|-------------|
|                  |                |               |       |                   | V/f Control           | V/f with PG | Open Loop Vector | Flux Vector |
| L3-03            | StallP CHP Lvl | 0 to 100      | %     | 100               | Advanced              |             |                  |             |

- Note 1.** This parameter cannot be changed during operation.
- Note 2.** The default setting will be changed to the following values if the control mode is changed:  
 Normal V/f control: 50, V/f control with PG feedback: 50, Open-loop vector control: 100
- Note 3.** N.A. = Not applicable.
- Normally it isn't necessary to change this setting.

- Set this parameter when a high-speed motor is being used in the high-speed range (the high frequency range above the base frequency).  
The standard target setting is the motor’s rated current. (Set this current value as a percentage of the Inverter’s rated current, i.e., 100% corresponds to the Inverter’s rated current.)

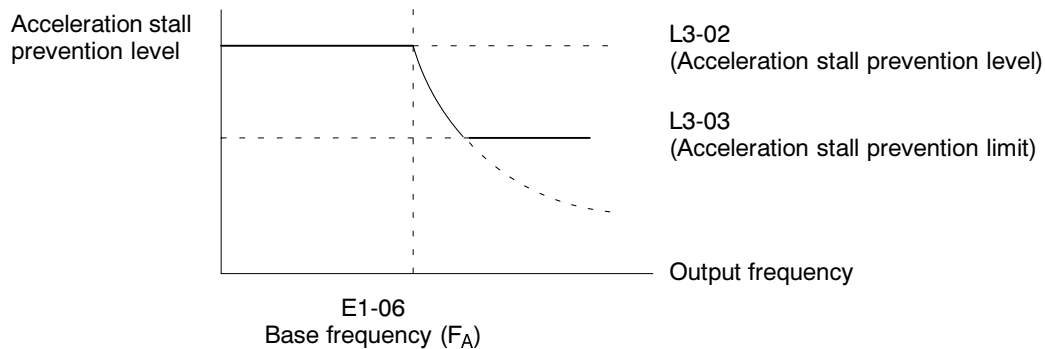

- When the motor is used in the high-speed range, the acceleration stall prevention level is automatically lowered to provide smoother acceleration.  
The acceleration stall prevention limit (L3-03) limits how much the acceleration stall prevention level is lowered so that it isn’t lowered any more than necessary.

| Parameter number | Display name     | Setting range | Units | Default setting | Valid access levels |             |                  |             |
|------------------|------------------|---------------|-------|-----------------|---------------------|-------------|------------------|-------------|
|                  |                  |               |       |                 | V/f Control         | V/f with PG | Open Loop Vector | Flux Vector |
| L3-04            | StallP Decel Sel | 0 to 2        | ---   | 1               | Basic or Advanced   |             |                  |             |

**Note** This parameter cannot be changed during operation.

| Setting | Function  |
|---------|---|
| 0       | Disabled. (Decelerate according to the settings. Main circuit over-voltage may occur if the deceleration time is too short.)      |
| 1       | Enabled. (Stops deceleration if the main circuit voltage exceeds the over-voltage level. Decelerate again when voltage recovers.) |
| 2       | Intelligent. (Decelerate as fast as possible judging from the main circuit voltage. Ignore the deceleration time setting.)        |

- When setting 1 (enabled) is selected, the deceleration time is extended automatically so that a main circuit over-voltage doesn’t occur.
- Always select setting 0 when a braking option (Braking Resistor, Braking Resistor Unit, or Braking Unit) is being used. If setting 1 or 2 is selected, the braking option won’t be used and the deceleration time can’t be shortened.



Deceleration Stall Prevention Example: L3-04 = 1

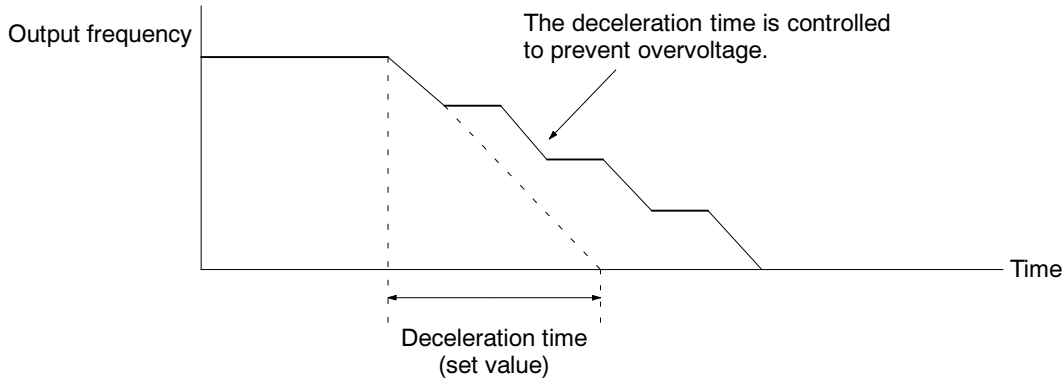

| Parameter number | Display name   | Setting range | Units | Default setting | Valid access levels |             |                  |             |
|------------------|----------------|---------------|-------|-----------------|---------------------|-------------|------------------|-------------|
|                  |                |               |       |                 | V/f Control         | V/f with PG | Open Loop Vector | Flux Vector |
| L3-05            | StallP Run Sel | 0 to 2        | ---   | 1               | Basic or Advanced   |             | Not applicable.  |             |

**Note** This parameter cannot be changed during operation.

| Setting | Function   |
|---------|--|
| 0       | Disabled. (Run according to the settings. Stalls may occur with large loads.)                  |
| 1       | Enabled – deceleration time 1. (Use deceleration time in C1-02 for stall prevention function.) |
| 2       | Enabled – deceleration time 2. (Use deceleration time in C1-04 for stall prevention function.) |

- When setting 1 or 2 (enabled) is selected, deceleration is started if the run stall prevention level’s current continues for more than 100 ms. The motor is accelerated back to the reference frequency again when the current falls below this level.

| Parameter number | Display name     | Setting range | Units | Default setting | Valid access levels |             |                  |             |
|------------------|------------------|---------------|-------|-----------------|---------------------|-------------|------------------|-------------|
|                  |                  |               |       |                 | V/f Control         | V/f with PG | Open Loop Vector | Flux Vector |
| L3-06            | StallP Run Level | 30 to 200     | %     | 160             | Basic or Advanced   |             | Not applicable.  |             |

**Note** This parameter cannot be changed during operation.

- This setting is valid when L3-05 is set to 1 or 2.
- Normally it isn’t necessary to change this setting.
- Decrease this setting when the motor’s capacity is small compared to the Inverter’s capacity or stalling occurs when the motor is operated with the default setting. The standard target setting is 2 to 3 times the motor’s rated current. (Set this current value as a percentage of the Inverter’s rated current, i.e., 100% corresponds to the Inverter’s rated current.)

Run Stall Prevention Example: L3-05 = 1 or 2

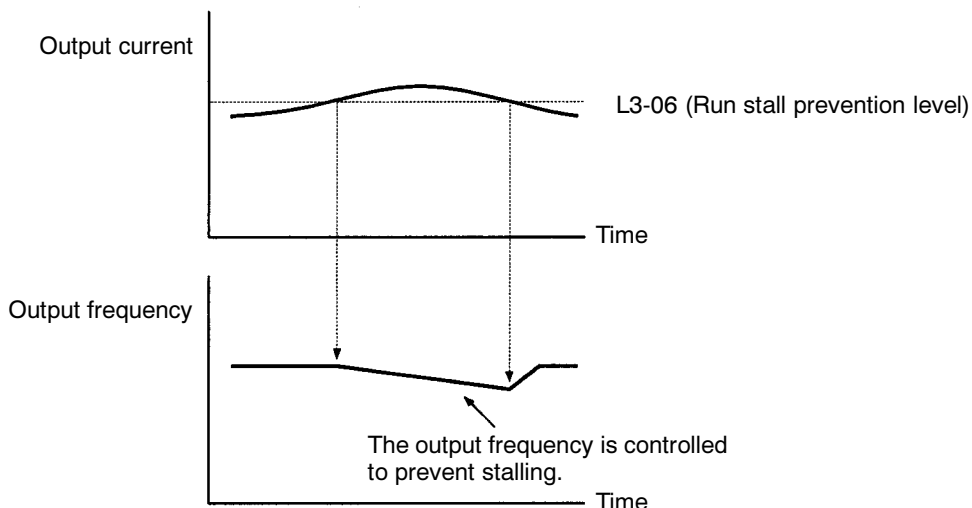

■ Frequency Detection Settings (L4)

| Parameter number | Display name     | Setting range    | Units | Default setting | Valid access levels |             |                  |             |
|------------------|------------------|------------------|-------|-----------------|---------------------|-------------|------------------|-------------|
|                  |                  |                  |       |                 | V/f Control         | V/f with PG | Open Loop Vector | Flux Vector |
| L4-01            | Spd Agree Level  | 0.0 to 400.0     | Hz    | 0.0             | Basic or Advanced   |             |                  |             |
| L4-02            | Spd Agree Width  | 0.0 to 20.0      | Hz    | 2.0             | Basic or Advanced   |             |                  |             |
| L4-03            | Spd Agree Lvl+-  | -400.0 to +400.0 | Hz    | 0.0             | Advanced            |             |                  |             |
| L4-04            | Spd Agree Wdth+- | 0.0 to 20.0      | Hz    | 2.0             | Advanced            |             |                  |             |

**Note** These parameters cannot be changed during operation.

- Set these parameters when outputting one of the frequency agree or frequency detection signals from a multi-function output (settings 2, 3, 4, 5, 13, 14, 15, or 16). The following table shows the relationship between these parameters and the output signals.

| Parameter                            | Related output settings   | Parameter function   |
|--------------------------------------|---|--|
| Speed Agree Level (Absolute value)   | Fref/Set Agree 1 (setting 3)<br>Frequency Detection 1 (setting 4)<br>Frequency Detection 2 (setting 5)                                      | Set the speed that you want to detect in Hz. The set speed is an absolute value, so the speed is detected in forward or reverse. |
| Speed Agree Width (Absolute value)   | Fref/Fout Agree 1 (setting 2)<br>Fref/Set Agree 1 (setting 3)<br>Frequency Detection 1 (setting 4)<br>Frequency Detection 2 (setting 5)     | Set the speed detection range in Hz.   |
| Speed Agree Level +/- (Signed value) | Fref/Set Agree 2 (setting 14)<br>Frequency Detection 3 (setting 15)<br>Frequency Detection 4 (setting 16)                                   | Set the speed that you want to detect in Hz. Set positive values for forward, negative values for reverse.                       |
| Speed Agree Width +/- (Signed value) | Fref/Fout Agree 2 (setting 13)<br>Fref/Set Agree 2 (setting 14)<br>Frequency Detection 3 (setting 15)<br>Frequency Detection 4 (setting 16) | Set the speed detection range in Hz.   |

- Set the corresponding setting in the multi-function output (H2-01, H2-02, or H2-03) to output the desired Fref/Fout Agree signal, Fref/Set Agree signal, or Frequency-Detection signal. There is a timing chart showing the operation of these signals on the following page.

| Parameter number | Display name | Setting range | Units | Default setting | Valid access levels |             |                  |             |
|------------------|--------------|---------------|-------|-----------------|---------------------|-------------|------------------|-------------|
|                  |              |               |       |                 | V/f Control         | V/f with PG | Open Loop Vector | Flux Vector |
| L4-05            | Ref Loss Sel | 0 or 1        | ---   | 0               | Advanced            |             |                  |             |

**Note** This parameter cannot be changed during operation.

| Setting | Function   |
|---------|--|
| 0       | Stop. (Operate according to the frequency reference value.)  |
| 1       | Continue operation at 80% speed. (Continue operation with a speed that is 80% of the value when the frequency reference was lost.) |

- The frequency reference is considered lost when the frequency reference voltage drops by 90% for more than 400 ms.

● Frequency Detection Operation

| Related parameter   | L4-01: Speed Agree Level<br>L4-02: Speed Agree Width  | L4-03: Speed Agree Level +/-<br>L4-04: Speed Agree Width +/-   |
|---------------------|---|--|
| Fref/Fout Agree     | <p>Fref/Fout Agree 1</p> <p>Fref/Fout Agree 1 OFF ON</p> <p>(Multi-function output setting = 2)</p>     | <p>Fref/Fout Agree 2</p> <p>Fref/Fout Agree 2 OFF ON</p> <p>(Multi-function output setting = 13)</p>     |
| Fref/Set Agree      | <p>Fref/Set Agree 1</p> <p>Fref/Set Agree 1 OFF ON</p> <p>(Multi-function output setting = 3)</p>       | <p>Fref/Set Agree 2</p> <p>Fref/Set Agree 2 OFF ON</p> <p>(Multi-function output setting = 14)</p>       |
| Frequency Detection | <p>Frequency Detection 1</p> <p>Freq. Detection 1 ON OFF</p> <p>(Multi-function output setting = 4)</p> | <p>Frequency Detection 3</p> <p>Freq. Detection 3 ON OFF</p> <p>(Multi-function output setting = 15)</p> |
|                     | <p>Frequency Detection 2</p> <p>Freq. Detection 2 OFF ON</p> <p>(Multi-function output setting = 5)</p> | <p>Frequency Detection 4</p> <p>Freq. Detection 4 OFF ON</p> <p>(Multi-function output setting = 16)</p> |

■ Fault Restart Settings (L5)

| Parameter number | Display name    | Setting range | Units | Default setting | Valid access levels |             |                  |             |
|------------------|-----------------|---------------|-------|-----------------|---------------------|-------------|------------------|-------------|
|                  |                 |               |       |                 | V/f Control         | V/f with PG | Open Loop Vector | Flux Vector |
| L5-01            | Num of Restarts | 0 to 10       | ---   | 0               | Basic or Advanced   |             |                  |             |

**Note** This parameter cannot be changed during operation.

**Caution** The Inverter might be damaged when using the fault restart function. Understanding that the Inverter might be damaged, be sure to take the following precautions:  
 Always set up a no-fuse breaker (NFB).  
 Set up a sequence that will stop peripheral equipment when an Inverter fault occurs.

- The fault restart function automatically restarts the Inverter even when an internal fault occurs during Inverter operation.
- Use this function only when continuing operation is more important than damaging the Inverter.
- The fault restart function is effective with the following faults. With other faults, the protective operations will engage immediately without attempting to restart operation.

- OC (Over-current)
- GF (Ground fault)
- PUF (Fuse blown)
- OV (Main circuit over-voltage)
- UV1 (Main circuit under-voltage)
- PF (Main circuit voltage fault)
- LF (Output open-phase)
- RF (Braking resistor overheated)
- RR (Braking transistor failure)
- OL1 (Motor overload)
- OL2 (Inverter overload)
- OL3 (Overtorque)
- OL4 (Overtorque)

- The fault restart count is cleared when operation is normal for 10 minutes after a fault restart is performed or the power is turned off and then on again.
- When one of the multi-function outputs (H2-01, H2-02, or H2-03) is set to 1E (Restart Enabled), the output will be ON while the fault restart function is in progress.

| Parameter number | Display name | Setting range | Units | Default setting | Valid access levels |             |                  |             |
|------------------|--------------|---------------|-------|-----------------|---------------------|-------------|------------------|-------------|
|                  |              |               |       |                 | V/f Control         | V/f with PG | Open Loop Vector | Flux Vector |
| L5-02            | Restart Sel  | 0 or 1        | ---   | 0               | Basic or Advanced   |             |                  |             |

**Note** This parameter cannot be changed during operation.

| Setting | Function   |
|---------|--|
| 0       | Do not output fault restart. (The fault contact does not operate.) |
| 1       | Output fault restart. (The fault contact operates.)                |

■ Overtorque Detection Settings (L6)

| Parameter number | Display name    | Setting range | Units | Default setting | Valid access levels |             |                  |             |
|------------------|-----------------|---------------|-------|-----------------|---------------------|-------------|------------------|-------------|
|                  |                 |               |       |                 | V/f Control         | V/f with PG | Open Loop Vector | Flux Vector |
| L6-01            | Torq Det 1 Sel  | 0 to 4        | ---   | 0               | Basic or Advanced   |             |                  |             |
| L6-02            | Torq Det 1 Lvl  | 0 to 300      | %     | 150             | Basic or Advanced   |             |                  |             |
| L6-03            | Torq Det 1 Time | 0.0 to 10.0   | s     | 0.1             | Basic or Advanced   |             |                  |             |
| L6-04            | Torq Det 2 Sel  | 0 to 4        | ---   | 0               | Advanced            |             |                  |             |
| L6-05            | Torq Det 2 Lvl  | 0 to 300      | %     | 150             | Advanced            |             |                  |             |
| L6-06            | Torq Det 2 Time | 0.0 to 10.0   | s     | 0.1             | Advanced            |             |                  |             |

**Note** These parameters cannot be changed during operation.

- The overtorque detection function detects an excessive mechanical load from an increase in the output current (or output torque).
- The settings in the torque detection selection parameters (L6-01 and L6-04) determine whether overtorque conditions will be detected and what kind of processing will be performed if a overtorque condition is detected.

**L6-01/L6-04 Settings**

| Setting | Function   |
|---------|--|
| 0       | No overtorque detection  |
| 1       | Detect only during speed agreement. Continue operation even after detection. (Minor fault) |
| 2       | Detect overtorque at any time. Continue operation even after detection. (Minor fault)      |
| 3       | Detect only during speed agreement. Stop output after detection. (Fault)                   |
| 4       | Detect overtorque at any time. Stop output after detection. (Fault)                        |

- When overtorque detection is enabled, be sure to set the overtorque detection level (L6-02 or L6-05) and the overtorque detection time (L6-02 or L6-05). An overtorque condition is detected when the current exceeds the overtorque detection level for longer than the overtorque detection time.
- The overtorque detection level settings depend on the control mode:
  - Open-loop or flux vector control: Set as a percentage of the motor’s rated torque.
  - Normal V/f or V/f with PG control: Set as a percentage of the Inverter’s rated output current.
- Any of the following functions can be set in a multi-function output (H2-01, H2-02, or H2-03) to indicate the fact that an overtorque condition has been detected.
  - Setting B: Overtorque detection 1 (N.O.)
  - Setting 17: Overtorque detection 1 (N.C.)
  - Setting 18: Overtorque detection 2 (N.O.)
  - Setting 19: Overtorque detection 2 (N.C.)

**Overtorque Detection Timing Chart**

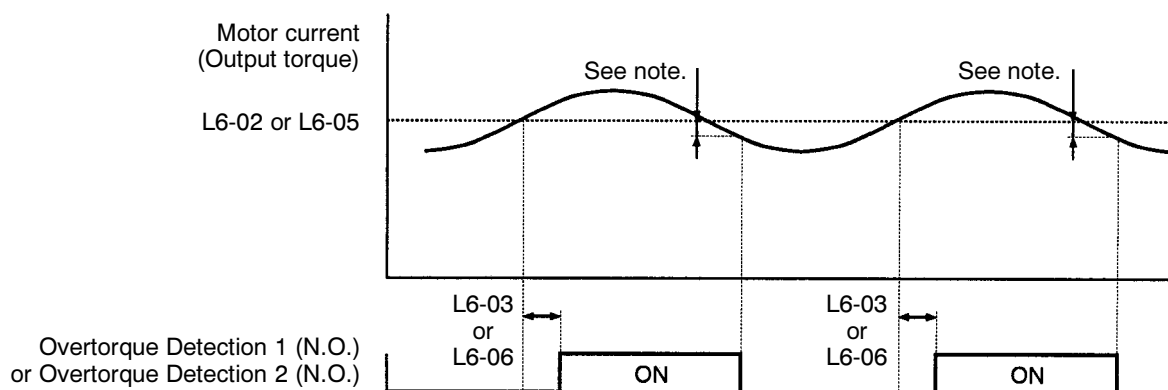

**Note** The overtorque detection is cleared when the current drops about 5% of the Inverter’s rated current (or the motor’s rated torque).

■ **Hardware Protection Settings (L8)**

| Parameter number | Display name     | Setting range | Units | Default setting | Valid access levels |             |                  |             |
|------------------|------------------|---------------|-------|-----------------|---------------------|-------------|------------------|-------------|
|                  |                  |               |       |                 | V/f Control         | V/f with PG | Open Loop Vector | Flux Vector |
| L8-01            | DB Resistor Prot | 0 or 1        | ---   | 0               | Basic or Advanced   |             |                  |             |

**Note** This parameter cannot be changed during operation.

| Setting | Function  |
|---------|---|
| 0       | Disabled. (Select 0 when a braking resistor isn’t being used or a Braking Resistor Unit is being used.) |
| 1       | Enabled. (Protects the braking resistor from overheating.)  |

| Parameter number | Display name     | Setting range | Units | Default setting | Valid access levels |             |                  |             |
|------------------|------------------|---------------|-------|-----------------|---------------------|-------------|------------------|-------------|
|                  |                  |               |       |                 | V/f Control         | V/f with PG | Open Loop Vector | Flux Vector |
| L8-02            | OH Pre-Alarm Lvl | 50 to 110     | °C    | 100             | Advanced            |             |                  |             |
| L8-03            | OH Pre-Alarm Sel | 0 to 3        | ---   | 3               | Advanced            |             |                  |             |

**Note** These parameters cannot be changed during operation.

- Parameter L8-02 specifies the detection temperature in °C for the Inverter overheat (OH) pre-alarm function. An overheat pre-alarm occurs when the temperature of the cooling fins reaches this level.
- Parameter L8-03 specifies the processing that will be performed when an overheat pre-alarm occurs.

| Setting | Name          | Function   |
|---------|---------------|--|
| 0       | Ramp to Stop  | Decelerates to a stop in the deceleration time set in C1-09. (Fault) |
| 1       | Coast to Stop | Coasts to a stop. (Fault)  |
| 2       | Fast-Stop     | Emergency stop in the fast-stop time set in C1-09. (Fault)           |
| 3       | Alarm Only    | Continues operation. (Monitor display only.) (Minor fault)           |

| Parameter number | Display name   | Setting range | Units | Default setting | Valid access levels |             |                  |             |
|------------------|----------------|---------------|-------|-----------------|---------------------|-------------|------------------|-------------|
|                  |                |               |       |                 | V/f Control         | V/f with PG | Open Loop Vector | Flux Vector |
| L8-05            | Ph Loss In Sel | 0 or 1        | ---   | 0               | Advanced            |             |                  |             |

**Note** This parameter cannot be changed during operation.

- This function detects changes in the main circuit’s DC voltage which indicate a power supply phase loss, large imbalance in the power supply voltage, or deterioration of the main circuit condenser.

| Setting | Function   |
|---------|--|
| 0       | Disabled.  |
| 1       | Enabled. (Detects input power supply phase loss, 3-phase imbalance, or deterioration of the main circuit condenser.) |

| Parameter number | Display name    | Setting range | Units | Default setting | Valid access levels |             |                  |             |
|------------------|-----------------|---------------|-------|-----------------|---------------------|-------------|------------------|-------------|
|                  |                 |               |       |                 | V/f Control         | V/f with PG | Open Loop Vector | Flux Vector |
| L8-07            | Ph Loss Out Sel | 0 or 1        | ---   | 0               | Advanced            |             |                  |             |

**Note** This parameter cannot be changed during operation.

- This function detects an Inverter output phase loss.

| Setting | Function   |
|---------|--|
| 0       | Disabled.  |
| 1       | Enabled. (Detects an output phase loss at under 10% of the Inverter’s rated output current.) |

- False phase loss detections may occur when the motor’s capacity is small compared to the capacity of the Inverter. In this case, disable the detection function by setting L8-07 to 0.

### 6-5-8 Operator Parameters: o

#### ■ Operator Display Selection (o1)

| Parameter number | Display name     | Setting range | Units | Default setting | Valid access levels |             |                  |             |
|------------------|------------------|---------------|-------|-----------------|---------------------|-------------|------------------|-------------|
|                  |                  |               |       |                 | V/f Control         | V/f with PG | Open Loop Vector | Flux Vector |
| o1-01            | User Monitor Sel | 4 to 28       | ---   | 6               | Basic or Advanced   |             |                  |             |

**Note** This parameter can be changed during operation.

- In operation mode, the frequency reference, output frequency, output current, and output voltage can be monitored immediately if the default settings are being used. One of these four values, the output voltage, can be changed to a different value. When you want to monitor a value other than the output voltage, set that value’s number in parameter o1-01.
- Use the last two digits from the “U1 Monitor” list (U1-□□) to select a value. Refer to page 3-12 for a table listing all of these U1 settings.

| Parameter number | Display name     | Setting range | Units | Default setting | Valid access levels |             |                  |             |
|------------------|------------------|---------------|-------|-----------------|---------------------|-------------|------------------|-------------|
|                  |                  |               |       |                 | V/f Control         | V/f with PG | Open Loop Vector | Flux Vector |
| o1-02            | Power-On Monitor | 1 to 4        | ---   | 1               | Basic or Advanced   |             |                  |             |

**Note** This parameter can be changed during operation.



- When the power is turned on, the frequency reference will appear in the Unit's data display if the default settings are being used. Any one of the four values monitored at startup (frequency reference, output frequency, output current, or the value set in parameter o1-01) can be selected to appear when the power is turned on. The value that appears automatically at startup is determined by parameter o1-02 (Power-On Monitor).

| Setting | Name                | Function   |
|---------|---------------------|--|
| 1       | Frequency reference | The frequency reference is displayed at start-up.          |
| 2       | Output Frequency    | The output frequency is displayed at start-up.             |
| 3       | Output Current      | The output current is displayed at start-up.               |
| 4       | User Monitor        | The value set in parameter o1-01 is displayed at start-up. |

■ Key Function Settings/Other Settings (o2)

| Parameter number | Display name     | Setting range | Units | Default setting | Valid access levels |             |                  |             |
|------------------|------------------|---------------|-------|-----------------|---------------------|-------------|------------------|-------------|
|                  |                  |               |       |                 | V/f Control         | V/f with PG | Open Loop Vector | Flux Vector |
| o2-01            | Local/Remote Key | 0, 1          | ---   | 1               | Basic or Advanced   |             |                  |             |

- This parameter enables or disables the LOCAL/REMOTE Key (the Operation Mode Selector Key) on the Digital Operator; it cannot be changed during operation.

| Setting | Function   |
|---------|--|
| 0       | Disabled.  |
| 1       | Enabled. (Pressing the LOCAL/REMOTE Key switches control of operation between the Operator and the sources specified in parameters b1-01 and b1-02.) |

| Parameter number | Display name  | Setting range | Units | Default setting | Valid access levels |             |                  |             |
|------------------|---------------|---------------|-------|-----------------|---------------------|-------------|------------------|-------------|
|                  |               |               |       |                 | V/f Control         | V/f with PG | Open Loop Vector | Flux Vector |
| o2-02            | Oper Stop Key | 0, 1          | ---   | 1               | Basic or Advanced   |             |                  |             |

- This parameter enables or disables the STOP on the Digital Operator; it cannot be changed during operation.

| Setting | Function  |
|---------|---|
| 0       | Disabled. (The STOP Key is disabled when the run command is input from an external terminal.) |
| 1       | Enabled. (The STOP Key is enabled at all times during operation.)                             |

| Parameter number | Display name  | Setting range | Units | Default setting | Valid access levels |             |                  |             |
|------------------|---------------|---------------|-------|-----------------|---------------------|-------------|------------------|-------------|
|                  |               |               |       |                 | V/f Control         | V/f with PG | Open Loop Vector | Flux Vector |
| o2-03            | User Defaults | 0, 1, or 2    | ---   | 0               | Basic or Advanced   |             |                  |             |

- This parameter is used to record or clear the user defaults; it cannot be changed during operation. Once the user defaults have been recorded, parameter A1-03 can be used to initialize the Inverter's parameters to these defaults.

| Setting | Function  |
|---------|---|
| 0       | No change. (Retain current settings.)   |
| 1       | Record user defaults. (Record the current parameter settings as user defaults.) |
| 2       | Clear user defaults. (Clear the recorded user defaults.)                        |

| Parameter number | Display name     | Setting range | Units | Default setting | Valid access levels |             |                  |             |
|------------------|------------------|---------------|-------|-----------------|---------------------|-------------|------------------|-------------|
|                  |                  |               |       |                 | V/f Control         | V/f with PG | Open Loop Vector | Flux Vector |
| o2-04            | Inverter Model # | 0 to FF       | ---   | 0               | Basic or Advanced   |             |                  |             |

- Do not change this parameter setting; it is used by the manufacturer to identify the Inverter model.
- The setting range and default setting depend on the Inverter capacity. The settings shown in the table are for a 200-V class, 0.4 kW Inverter.

| Parameter number | Display name    | Setting range | Units | Default setting | Valid access levels |             |                  |             |
|------------------|-----------------|---------------|-------|-----------------|---------------------|-------------|------------------|-------------|
|                  |                 |               |       |                 | V/f Control         | V/f with PG | Open Loop Vector | Flux Vector |
| o2-05            | Operator M.O.P. | 0, 1          | ---   | 0               | Advanced            |             |                  |             |

- This parameter determines whether it is necessary to press the Enter Key when changing the frequency reference with the Digital Operator’s frequency reference monitor; it cannot be changed during operation.
- When o2-05 is set to 1 (Enter Key input not required.), the frequency reference changes simultaneously with the Digital Operator’s value.

| Setting | Function                      |
|---------|-------------------------------|
| 0       | Enter Key input required.     |
| 1       | Enter Key input not required. |

| Parameter number | Display name   | Setting range | Units | Default setting | Valid access levels |             |                  |             |
|------------------|----------------|---------------|-------|-----------------|---------------------|-------------|------------------|-------------|
|                  |                |               |       |                 | V/f Control         | V/f with PG | Open Loop Vector | Flux Vector |
| o2-06            | Oper Detection | 0 or 1        | ---   | 0               | Advanced            |             |                  |             |

- This parameter specifies whether to stop operation when the Digital Operator is disconnected; it cannot be changed during operation.

| Setting | Function   |
|---------|--|
| 0       | Disable Operator detection. (Continue operation when the Digital Operator is disconnected.)  |
| 1       | Enable Operator detection. (Detect an OPR fault when the Digital Operator is disconnected, stop the Inverter output, and operate the fault contact.) |

| Parameter number | Display name     | Setting range | Units | Default setting | Valid access levels |             |                  |             |
|------------------|------------------|---------------|-------|-----------------|---------------------|-------------|------------------|-------------|
|                  |                  |               |       |                 | V/f Control         | V/f with PG | Open Loop Vector | Flux Vector |
| o2-07            | Elapsed Time Set | 0 to 65535    | h     | 0               | Advanced            |             |                  |             |
| o2-08            | Elapsed Time Run | 0 or 1        | ---   | 0               | Advanced            |             |                  |             |

**Note** These parameters cannot be changed during operation

- Set the initial elapsed time in parameter o2-07. The elapsed operating time will start from this value.
- Parameter o2-08 determines whether the elapsed operating time is the time that the Inverter is on or the time that the Inverter is running.

| Setting | Function   |
|---------|--|
| 0       | Inverter power-on time. (Counts the elapsed time from start-up until power is turned off.) |
| 1       | Inverter running time. (Counts the elapsed time that there is an Inverter output.)         |

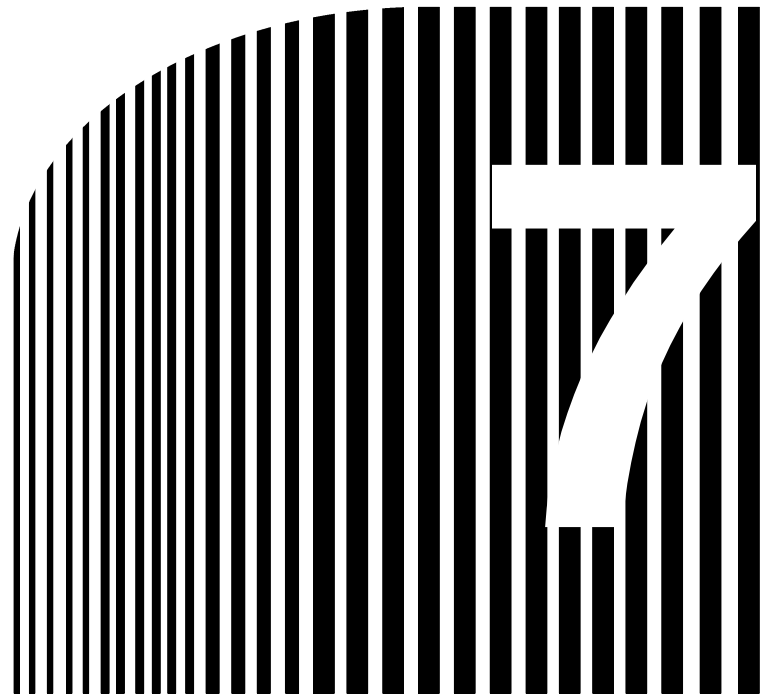

## Chapter 7

### • Parameter Lists •

- 7-1 Initialize Mode Parameters
- 7-2 Program Mode Parameter List

This sections lists all parameters that can be used in the Program and Initialize modes.

■ Using the Lists

| Constant No. | Name             | Description  | Setting range | Default setting | Changes during operation | Control mode |             |                  |             | Page |
|--------------|------------------|--|---------------|-----------------|--------------------------|--------------|-------------|------------------|-------------|------|
|              | Display name     |  |               |                 |                          | V/f control  | V/f with PG | Open loop vector | Flux vector |      |
| A1-00        | Display Language | Used to select the language displayed on the Digital Operator<br>0: English<br>1: Japanese<br>Note: This parameter is not initialized by the initialize operation. | 0, 1          | 1               | OK                       | Q            | Q           | Q                | Q           | 3-18 |
|              | Select Language  |  |               |                 |                          |              |             |                  |             |      |

- Constant No.**            The parameter constant number.
- Name**                    The parameter constant name.
- Display name**            The parameter constant name displayed on the Digital Operator.
- Description**            Details of the parameter constant function or setting value.
- Setting range**            The parameter constant setting range.
- Default setting**        The default setting value (each control mode has its own default setting. Therefore the default setting changes when the control mode is changed.)
- Changes during operation** Indicates whether or not the parameter can be changed while in the Inverter is in operation.  
     OK: Changes possible during operation.  
     NO: Changes not possible during operation.
- Control mode**            Indicates which control modes and which access levels can be set and referenced.  
     Q: Items which can be set and referenced on all access levels; QUICK-START, BASIC, and ADVANCED.  
     B: Items which can be set and referenced in BASIC and ADVANCED.  
     A: Items which can be set and referenced in ADVANCED only.  
     X: Items which cannot be set or referenced in that control mode.
- Page**                    Reference page for more detailed information on the parameter.

7-1 Initialize Mode Parameters

| Constant No. | Name                  | Description   | Setting range | Default setting | Changes during operation | Control mode |             |                  |             | Page |
|--------------|-----------------------|---|---------------|-----------------|--------------------------|--------------|-------------|------------------|-------------|------|
|              | Display name          |   |               |                 |                          | V/f control  | V/f with PG | Open loop vector | Flux vector |      |
| A1-00        | Display Language      | Used to select the language displayed on the Digital Operator<br>0: English<br>1: Japanese<br>Note: This parameter is not initialized by the initialize operation.  | 0, 1          | 1               | OK                       | Q            | Q           | Q                | Q           | 3-18 |
|              | Select Language       |   |               |                 |                          |              |             |                  |             |      |
| A1-01        | Access Level          | Used to set the parameter access level (set/read.)<br>0: Monitoring only (Displays only Operation mode and Initialize mode)<br>1: Used to select user constant (Constants A2-01 to A2-32 only can be set/read.)<br>2: QUICK-START<br>3: BASIC<br>4: ADVANCED                        | 0 to 4        | 2               | OK                       | Q            | Q           | Q                | Q           | 3-18 |
|              | Access Level          |   |               |                 |                          |              |             |                  |             |      |
| A1-02        | Select Control Method | Used to select the control method for the Inverter<br>0: V/f control<br>1: V/f with PG<br>2: Open loop vector<br>3: Flux vector<br>Note: This parameter is not initialized by the initialize operation.   | 0 to 3        | 2               | NO                       | Q            | Q           | Q                | Q           | 3-19 |
|              | Control Method        |   |               |                 |                          |              |             |                  |             |      |
| A1-03        | Initialize            | Used to initialize the parameters using the specified method.<br>0: No initializing<br>1110: Initializes using the User constants<br>2220: Initializes using a two-wire sequence.<br>3330: Initializes using a three-wire sequence.   | 0 to 3330     | 0               | NO                       | Q            | Q           | Q                | Q           | 3-20 |
|              | Init Parameters       |   |               |                 |                          |              |             |                  |             |      |
| A1-04        | Password              | When a password has been set in A1-05 this function write protects the password input section of the Operation mode parameter.<br>Note: If the password is changed, A1-01 to A1-03 and A2-01 to A2-32 constants can no longer be changed. (Program mode parameters can be changed.) | 0 to 9999     | 0               | NO                       | Q            | Q           | Q                | Q           | 3-22 |
|              | Enter Password        |   |               |                 |                          |              |             |                  |             |      |
| A1-05        | Setting the Password  | Used to set a four digit number as the password.<br>Note: This parameter is not usually displayed. When the password (A1-04) is displayed, hold down the Reset/Select Key and press the Menu Key and the password will be displayed.  | 0 to 9999     | 0               | NO                       | Q            | Q           | Q                | Q           | 3-22 |
|              | Select Password       |   |               |                 |                          |              |             |                  |             |      |

| Con-stant No.  | Name                      | Description  | Setting range  | Default setting | Chan-ges during operation | Control mode |             |                  |             | Page |
|----------------|---------------------------|--|----------------|-----------------|---------------------------|--------------|-------------|------------------|-------------|------|
|                | Display name              |  |                |                 |                           | V/f control  | V/f with PG | Open loop vector | Flux vector |      |
| A2-01 to A2-32 | Setting the User Constant | Used to set the parameter numbers that can be set/read. Maximum 32.<br><br>Note It is most effective to set the user setting constant to 1 in access level A1-01. If set in the Program mode only, parameters set in access levels A2-01 to A2-32 may be set/read. | b1-01 to o2-08 | ---             | NO                        | A            | A           | A                | A           | 3-22 |
|                | User Param 1 to 32        |  |                |                 |                           |              |             |                  |             |      |

## 7-2 Program Mode Parameter List

### 7-2-1 Application Group: b

#### ■ Operation Sequence Selection: b1

| Constant No. | Name  | Description   | Setting range | Default setting | Changes during operation | Control mode |             |                  |             | Page     |
|--------------|---|---|---------------|-----------------|--------------------------|--------------|-------------|------------------|-------------|----------|
|              | Display name  |   |               |                 |                          | V/f control  | V/f with PG | Open loop vector | Flux vector |          |
| b1-01        | Frequency Reference Selection                             | Used to set the input method for the reference frequency.<br>0: Digital Operator<br>1: Control circuit terminals (analog inputs).<br>2: Not used. (Do not set this value.)<br>3: Optional Card  | 0 to 3        | 1               | NO                       | Q            | Q           | Q                | Q           | 5-4, 5-8 |
|              | Reference Source  |   |               |                 |                          |              |             |                  |             |          |
| b1-02        | Run Source Selection                                      | Used to set the source of the run command.<br>0: Digital Operator<br>1: Control circuit terminals (sequence inputs).<br>2, 3: Not used. (Do not set this value.)  | 0 to 3        | 1               | NO                       | Q            | Q           | Q                | Q           | 5-10     |
|              | Run Source  |   |               |                 |                          |              |             |                  |             |          |
| b1-03        | Stopping Method Selection                                 | Used to set the stopping method used when a stop command is input.<br>0: Ramp to stop<br>1: Coast to stop.<br>2: DC braking stop: (Stops faster than coast to stop, without regenerative operation.)<br>3: Coast to stop with timer: Run commands are ignored during deceleration.<br>Note: Only settings 0 and 1 can be used with flux vector control.   | 0 to 3        | 0               | NO                       | Q            | Q           | Q                | Q           | 5-13     |
|              | Stopping Method   |   |               |                 |                          |              |             |                  |             |          |
| b1-04        | Disabling Reverse Operation                               | 0: Reverse enabled<br>1: Reverse disabled   | 0, 1          | 0               | NO                       | B            | B           | B                | B           | 5-12     |
|              | Reverse Oper  |   |               |                 |                          |              |             |                  |             |          |
| b1-05        | Operation Selection for Minimum Frequency (E1-09 or less) | Used to set the method of operation when the frequency reference input is less than the minimum frequency (E1-09).<br>0: Run at frequency reference (E1-09 not effective).<br>1: STOP (Frequencies below E1-09 in the coast to stop state.)<br>2: Run at min. frequency. (E1-09)<br>3: Run at zero speed (Frequencies below E1-09 are zero)<br>Note: This function is only available in with flux vector control. | 0 to 3        | 0               | NO                       | X            | X           | X                | A           | 5-32     |
|              | Zero-Speed Oper   |   |               |                 |                          |              |             |                  |             |          |

| Con-stant No. | Name   | Description   | Setting range | Default setting | Chang-es during opera-tion | Control mode |             |                  |             | Page |
|---------------|--|---|---------------|-----------------|----------------------------|--------------|-------------|------------------|-------------|------|
|               | Display name                                       |   |               |                 |                            | V/f control  | V/f with PG | Open loop vector | Flux vector |      |
| b1-06         | Setting Control In-put Re-sponsive-ness            | Used to set the responsiveness of the control inputs (forward/reverse and multi-function inputs.)<br>0: Two scans every 2 ms (Use when connecting transistor outputs.)<br>1: Two scans every 5 ms (Use when connecting contact outputs or switches.)  | 0, 1          | 1               | NO                         | A            | A           | A                | A           | 5-10 |
|               | Cntl Input Scans                                   |   |               |                 |                            |              |             |                  |             |      |
| b1-07         | Operation Selection After Switching to Remote Mode | Used to set the Operation mode by switching to the Remote mode using the Local/Remote Key.<br>0: Run signals that are input during mode switching are ignored. (Input Run signals after switching the mode.)<br>1: Run signals become effective immediately after switching to the Remote mode. | 0, 1          | 0               | NO                         | A            | A           | A                | A           | ---  |
|               | LOC/REM RUN Sel                                    |   |               |                 |                            |              |             |                  |             |      |



■ DC Braking: b2

| Constant No. | Name   | Description  | Setting range | Default setting | Changes during operation | Control mode |             |                  |             | Page       |
|--------------|--|--|---------------|-----------------|--------------------------|--------------|-------------|------------------|-------------|------------|
|              | Display name                                       |  |               |                 |                          | V/f control  | V/f with PG | Open loop vector | Flux vector |            |
| b2-01        | Excitation level (DC injection starting frequency) | Used to set the frequency which starts DC injection braking (the initial excitation for flux vector control) in units of 0.1 Hz when deceleration to stop is selected.<br>Note: When b2-01 is less than E1-09, E1-09 becomes the DC starting frequency. Only with flux vector control is b2-01 used. | 0.0 to 10.0   | 0.5             | NO                       | B            | B           | B                | B           | 6-36, 5-32 |
|              | DCInj Start Freq                                   |  |               |                 |                          |              |             |                  |             |            |
| b2-02        | DC injection braking current                       | Sets the DC injection braking current as a percentage of the inverter rated current.<br>Note: The initial excitation current for flux vector control depends on the E2-03 setting.   | 0 to 100      | 50              | NO                       | B            | B           | B                | X           | 6-36       |
|              | DCInj Current                                      |  |               |                 |                          |              |             |                  |             |            |
| b2-03        | DC injection braking time at start.                | Used to set the time to perform DC injection braking (initial excitation for flux vector control) at start in units of 1 second.<br>Note: Used to stop the load rotating and restart it. When the set value is 0, DC injection braking at start is not performed.                                    | 0.00 to 10.00 | 0.00            | NO                       | B            | B           | B                | B           | 6-36, 5-32 |
|              | DCInj Time@Start                                   |  |               |                 |                          |              |             |                  |             |            |
| b2-04        | DC injection braking time at stop.                 | Used to set the time to perform DC injection braking (initial excitation for flux vector control) at stop in units of 1 second.<br>Note: Used to prevent coasting after the stop command is input. When the set value is 0.00, DC injection braking at stop is not performed.                        | 0.00 to 10.00 | 0.50            | NO                       | B            | B           | B                | B           | 6-36, 5-32 |
|              | DOInj Time@stop                                    |  |               |                 |                          |              |             |                  |             |            |

■ Speed Search: b3

| Constant No. | Name                            | Description   | Setting range | Default setting | Changes during operation | Control mode |             |                  |             | Page |
|--------------|---------------------------------|---|---------------|-----------------|--------------------------|--------------|-------------|------------------|-------------|------|
|              | Display name                    |   |               |                 |                          | V/f control  | V/f with PG | Open loop vector | Flux vector |      |
| b3-01        | Speed search selection at start | Sets the speed search function to start when the run command is input.<br>0: Disabled (Starts from the minimum output frequency.)<br>1: Enabled (Speed search is started from the maximum frequency. In a control mode with PG, the motor starts at the frequency of motor rotation when the run command is input.) | 0, 1          | 0 (See note.)   | NO                       | A            | A           | A                | A           | 6-37 |
|              | Spd Srch at Start               |   |               |                 |                          |              |             |                  |             |      |
| b3-02        | Speed search operation current  | Sets the speed search operation current as a percentage of the Inverter rated current.<br><br>Note: Not usually necessary to set. When restarting is not possible with the set value, reduce the value.   | 0 to 200      | 150             | NO                       | A            | X           | A                | X           | 6-38 |
|              | Spd Srch Current                |   |               |                 |                          |              |             |                  |             |      |
| b3-03        | Speed search deceleration time  | Sets the output frequency deceleration time during speed search in 1-second units.<br><br>Note: Set the time for deceleration from the maximum frequency to 0 Hz.   | 0.0 to 10.0   | 2.0             | NO                       | A            | X           | A                | X           | 6-38 |
|              | Spd Srch Dec Time               |   |               |                 |                          |              |             |                  |             |      |

**Note** When the control mode is changed, the Inverter reverts to default settings. (The open loop vector control default settings will be displayed.)

■ Timer Function: b4

| Constant No. | Name                          | Description   | Setting range | Default setting | Changes during operation | Control mode |             |                  |             | Page |
|--------------|-------------------------------|---|---------------|-----------------|--------------------------|--------------|-------------|------------------|-------------|------|
|              | Display name                  |   |               |                 |                          | V/f control  | V/f with PG | Open loop vector | Flux vector |      |
| b4-01        | Timer function ON-delay time  | Sets the timer function output ON-delay time (dead band) for the timer function input, in 1-second units.<br><br>Note: Enabled when the timer function is set for multi-function inputs and outputs.  | 0.0 to 300.0  | 0.0             | NO                       | A            | A           | A                | A           | 6-39 |
|              | Delay-ON Timer                |   |               |                 |                          |              |             |                  |             |      |
| b4-02        | Timer function OFF-delay time | Sets the timer function output OFF-delay time (dead band) for the timer function input, in 1-second units.<br><br>Note: Enabled when the timer function is set for multi-function inputs and outputs. | 0.0 to 300.0  | 0.0             | NO                       | A            | A           | A                | A           | 6-39 |
|              | Delay-OFF Timer               |   |               |                 |                          |              |             |                  |             |      |

■ PID Control: b5

| Constant No. | Name                            | Description  | Setting range   | Default setting | Changes during operation | Control mode |             |                  |             | Page |
|--------------|---------------------------------|--|-----------------|-----------------|--------------------------|--------------|-------------|------------------|-------------|------|
|              | Display name                    |  |                 |                 |                          | V/f control  | V/f with PG | Open loop vector | Flux vector |      |
| b5-01        | PID control selection           | 0: Disabled<br>1: Enabled (Deviation is D-controlled.)<br>2: Enabled (Feedback value is D-controlled.)                       | 0 to 2          | 0               | NO                       | A            | A           | A                | A           | 6-42 |
|              | PID Mode                        |  |                 |                 |                          |              |             |                  |             |      |
| b5-02        | Proportional gain (P)           | Sets P-control proportional gain as a percentage.<br>Note: P-control is not performed when the setting is 0.00.              | 0.00 to 10.00   | 1.00            | NO                       | A            | A           | A                | A           | 6-42 |
|              | PID Gain                        |  |                 |                 |                          |              |             |                  |             |      |
| b5-03        | Integral time (I)               | Sets I-control integral time in 1-second units.<br>Note: I-control is not performed when the setting is 0.0.                 | 0.0 to 360.0    | 1.0             | NO                       | A            | A           | A                | A           | 6-42 |
|              | PID I Time                      |  |                 |                 |                          |              |             |                  |             |      |
| b5-04        | Integral limit (I)              | Sets the I-control limit as a percentage of the maximum frequency.   | 0.0 to 100.0    | 100.0           | NO                       | A            | A           | A                | A           | 6-42 |
|              | PID I Limit                     |  |                 |                 |                          |              |             |                  |             |      |
| b5-05        | Differential time (D)           | Sets D-control differential time in 1-second units.<br>Note: D-control is not performed when the setting is 0.00.            | 0.00 to 10.00   | 0.00            | NO                       | A            | A           | A                | A           | 6-42 |
|              | PID D Time                      |  |                 |                 |                          |              |             |                  |             |      |
| b5-06        | PID limit                       | Sets the limit after PID-control as a percentage of the maximum frequency.   | 0.0 to 100.0    | 100.0           | NO                       | A            | A           | A                | A           | 6-43 |
|              | PID Limit                       |  |                 |                 |                          |              |             |                  |             |      |
| b5-07        | PID offset adjustment           | Sets the offset after PID-control as a percentage of the maximum frequency.  | -100.0 to 100.0 | 0.0             | NO                       | A            | A           | A                | A           | 6-43 |
|              | PID Offset                      |  |                 |                 |                          |              |             |                  |             |      |
| b5-08        | PID primary delay time constant | Sets the time constant for low pass filter for PID-control outputs in 1-second units.<br>Note: Not usually necessary to set. | 0.00 to 10.00   | 0.00            | NO                       | A            | A           | A                | A           | 6-43 |
|              | PID Delay Time                  |  |                 |                 |                          |              |             |                  |             |      |

■ Reference Hold: b6

| Constant No. | Name                     | Description   | Setting range | Default setting | Changes during operation | Control mode |             |                  |             | Page |
|--------------|--------------------------|---|---------------|-----------------|--------------------------|--------------|-------------|------------------|-------------|------|
|              | Display name             |   |               |                 |                          | V/f control  | V/f with PG | Open loop vector | Flux vector |      |
| b6-01        | Dwell frequency at start | Note: The dwell function is used to stop/start the output frequency temporarily when driving a motor with a heavy load.<br><br> | 0.0 to 400.0  | 0.0             | NO                       | A            | A           | A                | A           | 6-46 |
|              | Dwell Ref @Start         |   |               |                 |                          |              |             |                  |             |      |
| b6-02        | Dwell time at start      |   | 0.0 to 10.0   | 0.0             | NO                       | A            | A           | A                | A           | 6-46 |
|              | Dwell Time @Start        |   |               |                 |                          |              |             |                  |             |      |
| b6-03        | Dwell frequency at stop  | 0.0 to 400.0  | 0.0           | NO              | A                        | A            | A           | A                | 6-46        |      |
|              | Dwell Ref @Stop          |   |               |                 |                          |              |             |                  |             |      |
| b6-04        | Dwell time at stop       | 0.0 to 10.0   | 0.0           | NO              | A                        | A            | A           | A                | 6-46        |      |
|              | Dwell Time @Stop         |   |               |                 |                          |              |             |                  |             |      |

■ Droop Control: b7

| Constant No. | Name                     | Description   | Setting range | Default setting | Changes during operation | Control mode |             |                  |             | Page |
|--------------|--------------------------|---|---------------|-----------------|--------------------------|--------------|-------------|------------------|-------------|------|
|              | Display name             |   |               |                 |                          | V/f control  | V/f with PG | Open loop vector | Flux vector |      |
| b7-01        | Droop control gain       | Sets the slip as a percentage of maximum frequency when the maximum frequency is specified and the rated torque occurs. | 0.0 to 100.0  | 0.0             | NO                       | X            | X           | X                | A           | 6-14 |
|              | Droop gain               | Note: Droop-control is not performed when the setting is 0.0.   |               |                 |                          |              |             |                  |             |      |
| b7-02        | Droop control delay time | Droop control responsiveness parameter  | 0.00 to 1.00  | 0.00            | NO                       | X            | X           | X                | A           | 6-14 |
|              | Droop delay time         | Note: When hunting or vibration occurs, increase the value.   |               |                 |                          |              |             |                  |             |      |

■ Energy Saving: b8

| Con-stant No. | Name                    | Description   | Setting range | Default setting | Chang-es during opera-tion | Control mode |             |                  |             | Page       |
|---------------|-------------------------|---|---------------|-----------------|----------------------------|--------------|-------------|------------------|-------------|------------|
|               | Display name            |   |               |                 |                            | V/f control  | V/f with PG | Open loop vector | Flux vector |            |
| b8-01         | Energy-saving gain      | Sets the Inverter output voltage when the energy-saving command is input.<br>Note: Enabled when the “energy-save mode” command is set for multi-function input. Set as a percentage of the V/f pattern voltage.   | 0 to 100      | 80              | NO                         | A            | A           | X                | X           | 6-10, 6-32 |
|               | Energy Save Gain        |   |               |                 |                            |              |             |                  |             |            |
| b8-02         | Energy-saving frequency | Sets the energy-saving effective range minimum frequency in Hz.<br>Note: The energy-saving function is only enabled when the frequency is greater than the energy-saving frequency and the speeds are consistent. | 0.0 to 400.0  | 0.0             | NO                         | A            | A           | X                | X           | 6-10, 6-32 |
|               | Energy Save Freq        |   |               |                 |                            |              |             |                  |             |            |

■ Zero Servo: b9

| Con-stant No. | Name                        | Description   | Setting range | Default setting | Chang-es during opera-tion | Control mode |             |                  |             | Page |
|---------------|-----------------------------|---|---------------|-----------------|----------------------------|--------------|-------------|------------------|-------------|------|
|               | Display name                |   |               |                 |                            | V/f control  | V/f with PG | Open loop vector | Flux vector |      |
| b9-01         | Zero-servo gain             | Used to adjust the strength of the zero-servo lock.<br>Note: Enabled when the “zero-servo command” is set for the multi-function input. When the zero-servo command has been input and the frequency reference drops below excitation level (b2-01), a position control loop is created and the motor stops. Increasing the zero-servo gain in turn increases the strength of the lock. Increasing it by too much will cause vibration.       | 0 to 100      | 5               | NO                         | X            | X           | X                | A           | 6-15 |
|               | Zero Servo Gain             |   |               |                 |                            |              |             |                  |             |      |
| b9-02         | Zero-servo completion width | Sets the output width of the P-lock completion signal.<br>Note: Enabled when the “zero-servo completion (end)” is set for multi-function output. The zero-servo completion signal is ON when the current position is within the range (the zero-servo position ± zero-servo completion width.)<br>Set the allowable position displacement from the zero-servo position to 4 times the pulse rate of the PG (pulse generator, encoder) in use. | 0 to 16383    | 10              | NO                         | X            | X           | X                | A           | 6-15 |
|               | Zero Servo Count            |   |               |                 |                            |              |             |                  |             |      |

## 7-2-2 Tuning Parameters

### ■ Acceleration/Deceleration: C1

| Constant No. | Name                                 | Description   | Setting range             | Default setting | Changes during operation | Control mode |             |                  |             | Page       |            |
|--------------|--------------------------------------|---|---------------------------|-----------------|--------------------------|--------------|-------------|------------------|-------------|------------|------------|
|              | Display name                         |   |                           |                 |                          | V/f control  | V/f with PG | Open loop vector | Flux vector |            |            |
| C1-01        | Acceleration time 1                  | Sets the acceleration time to accelerate from 0 to the maximum frequency, in 1-second units.  | 0.0 to 6000.0 (See note.) | 10.0            | OK                       | Q            | Q           | Q                | Q           | 5-11, 5-17 |            |
|              | Acceleration Time 1                  |   |                           |                 |                          |              |             |                  |             |            |            |
| C1-02        | Deceleration time 1                  | Sets the deceleration time to decelerate from the maximum frequency to 0, in 1-second units.  |                           |                 | OK                       | Q            | Q           | Q                | Q           | Q          | 5-11, 5-17 |
|              | Deceleration Time 1                  |   |                           |                 |                          |              |             |                  |             |            |            |
| C1-03        | Acceleration time 2                  | The acceleration time when the multi-function input "multi-accel/decel time 1" is set to ON.  |                           |                 | OK                       | B            | B           | B                | B           | B          | 5-11, 5-17 |
|              | Acceleration Time 2                  |   |                           |                 |                          |              |             |                  |             |            |            |
| C1-04        | Deceleration time 2                  | The deceleration time when the multi-function input "multi-accel/decel time 1" is set to ON.  |                           |                 | OK                       | B            | B           | B                | B           | B          | 5-11, 5-17 |
|              | Deceleration Time 2                  |   |                           |                 |                          |              |             |                  |             |            |            |
| C1-05        | Acceleration time 3                  | The acceleration time when the multi-function input "multi-accel/decel time 2" is set to ON.  |                           |                 | NO                       | A            | A           | A                | A           | A          | 5-11, 5-17 |
|              | Acceleration Time 3                  |   |                           |                 |                          |              |             |                  |             |            |            |
| C1-06        | Deceleration time 3                  | The deceleration time when the multi-function input "multi-accel/decel time 2" is set to ON.  | NO                        | A               | A                        | A            | A           | A                | 5-11, 5-17  |            |            |
|              | Deceleration Time 3                  |   |                           |                 |                          |              |             |                  |             |            |            |
| C1-07        | Acceleration time 4                  | The acceleration time when the multi-function input "multi-accel/decel time 1" and "multi-accel/decel time 2" are set to ON.  | NO                        | A               | A                        | A            | A           | A                | 5-11, 5-17  |            |            |
|              | Acceleration Time 4                  |   |                           |                 |                          |              |             |                  |             |            |            |
| C1-08        | Deceleration time 4                  | The deceleration time when the multi-function input "multi-accel/decel time 1" and "multi-accel/decel time 2" are set to ON.  | NO                        | A               | A                        | A            | A           | A                | 5-11, 5-17  |            |            |
|              | Deceleration Time 4                  |   |                           |                 |                          |              |             |                  |             |            |            |
| C1-09        | Emergency stop time                  | The deceleration time when the multi-function input "Emergency (fast) stop" is set to ON.<br>Note: This function can be used a stopped method when a fault has been detected. | OK                        | B               | B                        | B            | B           | B                | 5-12, 5-17  |            |            |
|              | Fast Stop Time                       |   |                           |                 |                          |              |             |                  |             |            |            |
| C1-10        | Acceleration/deceleration time units | 0: 0.01-second units<br>1: 0.1-second units   | 0, 1                      | 1               | NO                       | A            | A           | A                | A           | 5-11, 5-17 |            |
|              | Acc/Dec Units                        |   |                           |                 |                          |              |             |                  |             |            |            |

| Constant No. | Name  | Description   | Setting range | Default setting | Changes during operation | Control mode |             |                  |             | Page |
|--------------|---|---|---------------|-----------------|--------------------------|--------------|-------------|------------------|-------------|------|
|              | Display name                                  |   |               |                 |                          | V/f control  | V/f with PG | Open loop vector | Flux vector |      |
| C1-11        | Acceleration/deceleration switching frequency | Sets the frequency for automatic acceleration/deceleration switching.<br>Below set frequency: Accel/decel time 4, above set frequency: Accel/decel time 1<br><br>Note: The multi-function input "multi-accel/decel time 1" or "multi-accel/decel time 2" take priority. | 0.0 to 400.0  | 0.0             | NO                       | A            | A           | A                | A           | 5-12 |
|              | Acc/Dec SW Freq                               |   |               |                 |                          |              |             |                  |             |      |

**Note** The setting range for acceleration/deceleration times will differ according to the setting for C1-10 (the unit for acceleration/deceleration time.) When C1-10 is set to 0, the setting range for acceleration/deceleration times becomes 0.00 to 600.00 seconds.

■ S-curve Acceleration/Deceleration: C2

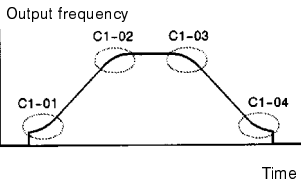
| Constant No. | Name   | Description   | Setting range | Default setting | Changes during operation | Control mode |             |                  |             | Page |      |
|--------------|--|---|---------------|-----------------|--------------------------|--------------|-------------|------------------|-------------|------|------|
|              | Display name                                       |   |               |                 |                          | V/f control  | V/f with PG | Open loop vector | Flux vector |      |      |
| C2-01        | S-curve characteristic time at acceleration start. | All sections of the S-curve characteristic time are set in seconds units.<br><br>Note: When the S-curve characteristic time is set, the accel/decel times will increase by only half of the S-curve characteristic times at start and end.<br><br> | 0.00 to 2.50  | 0.20            | NO                       | A            | A           | A                | A           | 6-47 |      |
|              | SCrv Acc @ Start                                   |   |               |                 |                          |              |             |                  |             |      |      |
| C2-02        | S-curve characteristic time at acceleration end.   |   | 0.00 to 2.50  | 0.20            | NO                       | A            | A           | A                | A           | A    | 6-47 |
|              | SCrv Acc @ End                                     |   |               |                 |                          |              |             |                  |             |      |      |
| C2-03        | S-curve characteristic time at deceleration start. | 0.00 to 2.50  | 0.20          | NO              | A                        | A            | A           | A                | A           | 6-47 |      |
|              | SCrv Dec @ Start                                   |   |               |                 |                          |              |             |                  |             |      |      |
| C2-04        | S-curve characteristic time at deceleration end.   | 0.00 to 2.50  | 0.00          | NO              | A                        | A            | A           | A                | A           | 6-47 |      |
|              | SCrv Dec @ End                                     |   |               |                 |                          |              |             |                  |             |      |      |

■ Motor-Slip Compensation: C3

| Constant No. | Name                                   | Description  | Setting range | Default setting | Changes during operation | Control mode |             |                  |             | Page       |
|--------------|--|--|---------------|-----------------|--------------------------|--------------|-------------|------------------|-------------|------------|
|              | Display name                           |  |               |                 |                          | V/f control  | V/f with PG | Open loop vector | Flux vector |            |
| C3-01        | Slip compensation gain.                | Used to improve speed accuracy when operating with a load.<br>Note: Usually setting is not necessary.<br>When actual speed is low, increase the set value.<br>When actual speed is high, decrease the set value.<br>In flux vector control mode this function becomes gain to compensate for slip caused by temperature variation.   | 0.0 to 2.5    | 1.0 (See note.) | OK                       | B            | X           | B                | B           | 6-48, 6-30 |
|              | Slip Comp Gain                         |  |               |                 |                          |              |             |                  |             |            |
| C3-02        | Slip compensation primary delay time.  | Slip compensation primary delay time is set in ms units.<br>Note: Usually setting is not necessary.<br>Adjust when slip compensation responsiveness is low, or speed is not stabilized.<br>When responsiveness is low, decrease the set value.<br>When speed is not stabilized, increase the set value.  | 0 to 10000    | 200 (See note.) | NO                       | A            | X           | A                | X           | 6-48       |
|              | Slip Comp Time                         |  |               |                 |                          |              |             |                  |             |            |
| C3-03        | Slip compensation limit.               | Sets the slip compensation limit as a percentage of motor rated slip.  | 0 to 250      | 200             | NO                       | A            | X           | A                | X           | 6-49       |
|              | Slip Comp Limit                        |  |               |                 |                          |              |             |                  |             |            |
| C3-04        | Slip compensation during regeneration. | 0: Disabled.<br>1: Enabled.<br>Note: When the slip compensation during regeneration function has been activated, as regeneration capacity increases momentarily, it may be necessary to use a braking option (braking resistor, Braking Resistor Unit or Braking Unit.)  | 0, 1          | 0               | NO                       | A            | A           | A                | X           | 6-49       |
|              | Slip Comp Regen                        |  |               |                 |                          |              |             |                  |             |            |
| C3-05        | Flux Calculation Method                | Used to set the flux calculation method. Normally, this setting is not required.<br>0: Flux is calculated based on the output frequency after frequencies using slip compensation, etc.<br>1: Flux is calculated based on the output frequency before correcting frequencies using slip compensation, etc.<br>Note: Set to "1" when motor rotation becomes unstable due to interference using slip compensation. | 0, 1          | 0               | NO                       | X            | X           | A                | X           | ---        |
|              | Flux Select                            |  |               |                 |                          |              |             |                  |             |            |

**Note** When the control mode is changed, the Inverter reverts to default settings. (The open loop vector control default settings will be displayed.)



■ Torque Compensation: C4

| Constant No. | Name                            | Description   | Setting range | Default setting | Changes during operation | Control mode |             |                  |             | Page |
|--------------|---------------------------------|---|---------------|-----------------|--------------------------|--------------|-------------|------------------|-------------|------|
|              | Display name                    |   |               |                 |                          | V/f control  | V/f with PG | Open loop vector | Flux vector |      |
| C4-01        | Torque compensation gain.       | <p>Sets torque compensation gain as a ratio.</p> <p>Note: Usually setting is not necessary. Adjust in the following circumstances:</p> <p>When the cable is long; increase the set value.</p> <p>When the motor capacity is smaller than the capacity of the Inverter (Max. applicable motor capacity), increase the set values.</p> <p>When the motor is vibrating, decrease the set values.</p> <p>Adjust the output current range at minimum speed rotation so that it does not exceed 50% of the Inverter rated output current. If it is set at greater than 50% the Inverter may be damaged.</p> | 0.00 to 2.50  | 1.00            | OK                       | B            | B           | B                | X           | 6-49 |
|              | Torq Comp Gain                  |   |               |                 |                          |              |             |                  |             |      |
| C4-02        | Torque compensation delay time. | <p>The torque compensation delay time is set in ms units.</p> <p>Note: Usually setting is not necessary. Adjust in the following circumstances:</p> <p>When the motor is vibrating, increase the set values.</p> <p>When the responsiveness of the motor is low, decrease the set values.</p>   | 0 to 10000    | 20 (See note.)  | NO                       | A            | A           | A                | X           | 6-50 |
|              | Torq Comp Time                  |   |               |                 |                          |              |             |                  |             |      |

**Note** When the control mode is changed, the Inverter reverts to default settings. (The open loop vector control default settings will be displayed.)

■ Speed Control (ASR): C5

| Constant No. | Name                        | Description  | Setting range   | Default setting   | Changes during operation | Control mode |             |                  |             | Page       |
|--------------|-----------------------------|--|-----------------|-------------------|--------------------------|--------------|-------------|------------------|-------------|------------|
|              | Display name                |  |                 |                   |                          | V/f control  | V/f with PG | Open loop vector | Flux vector |            |
| C5-01        | ASR Proportional (P) gain 1 | Sets the proportional gain of the speed loop (ASR.)  | 0.00 to 300.00  | 20.0 (See note.)  | OK                       | X            | B           | X                | B           | 5-36, 5-46 |
|              | ASR P Gain 1                |  |                 |                   |                          |              |             |                  |             |            |
| C5-02        | ASR Integral (I) time 1     | Sets the integral time of the speed loop (ASR) in 1-second units.  | 0.000 to 10.000 | 0.500 (See note.) | OK                       | X            | B           | X                | B           | 5-36, 5-46 |
|              | ASR I Gain 1                |  |                 |                   |                          |              |             |                  |             |            |
| C5-03        | ASR Proportional Gain (P) 2 | Usually setting is not necessary. Note: Set to change the rotational speed gain.   | 0.00 to 300.00  | 20.0 (See note.)  | OK                       | X            | B           | X                | B           | 5-36, 5-46 |
|              | ASR P Gain 2                |  |                 |                   |                          |              |             |                  |             |            |
| C5-04        | ASR Integral (I) time 2     |  | 0.000 to 10.000 | 0.500 (See note.) | OK                       | X            | B           | X                | B           | 5-36, 5-46 |
|              | ASR I Time 2                |  |                 |                   |                          |              |             |                  |             |            |
| C5-05        | ASR Limit                   | Sets the upper limit for the compensation frequency for the speed loop (ASR) to a percentage of the maximum frequency.   | 0.0 to 20.0     | 5.0               | NO                       | X            | A           | X                | X           | 5-49       |
|              | ASR Limit                   |  |                 |                   |                          |              |             |                  |             |            |
| C5-06        | ASR Primary delay time      | Sets the filter time constant; the time from the speed loop to the torque command output, in units of 1-second. Note: Usually setting is not necessary.  | 0.000 to 0.500  | 0.004             | NO                       | X            | X           | X                | A           | 5-38       |
|              | ASR Delay Time              |  |                 |                   |                          |              |             |                  |             |            |
| C5-07        | ASR Switching frequency     | Sets the frequency for switching between Proportion Gain 1, 2 and Integral Time 1, 2 in Hz units. Note: The multi-function input "ASR Gain SW" takes priority.   | 0.0 to 400.0    | 0.0               | NO                       | X            | X           | X                | A           | 5-37       |
|              | ASR Gain SW Freq            |  |                 |                   |                          |              |             |                  |             |            |
| C5-08        | ASR Integral (I) Limit      | Used to set the limit to the integral of the speed loop (ASR). Normally, this setting is not required. Note: Set to a small value to prevent any radical load change. Set to 100% of the maximum output frequency. | 0 to 400        | 400               | NO                       | X            | X           | X                | A           | ---        |
|              | ASR I Limit                 |  |                 |                   |                          |              |             |                  |             |            |

**Note** When the control mode is changed, the Inverter reverts to default settings. (The open loop vector control default settings will be displayed.)

■ Carrier Frequency: C6

| Constant No. | Name                                 | Description   | Setting range               | Default setting      | Changes during operation | Control mode |             |                  |             | Page |
|--------------|--------------------------------------|---|-----------------------------|----------------------|--------------------------|--------------|-------------|------------------|-------------|------|
|              | Display name                         |   |                             |                      |                          | V/f control  | V/f with PG | Open loop vector | Flux vector |      |
| C6-01        | Carrier frequency upper limit.       | Sets the carrier frequency upper limit and lower limit in kHz units. (See note 2)<br>The carrier frequency proportional gain is set as follows: | 2.0 to 15.0<br>(see note 1) | 15.0<br>(see note 1) | NO                       | B            | B           | B                | B           | 6-51 |
|              | Carrier Freq Max                     |   |                             |                      |                          |              |             |                  |             |      |
| C6-02        | Carrier frequency lower limit.       | Note: In vector control mode, the upper limit of the carrier frequency is fixed at C6-01<br><br>Carrier frequency                               | 0.4 to 15.0<br>(see note 1) | 15.0<br>(see note 1) | NO                       | A            | A           | X                | X           | 6-51 |
|              | Carrier Freq Min                     |   |                             |                      |                          |              |             |                  |             |      |
| C6-03        | Carrier frequency proportional gain. |   | 0 to 99                     | 0                    | NO                       | A            | A           | X                | X           | 6-51 |
|              | Carrier Freq Gain                    |   |                             |                      |                          |              |             |                  |             |      |

**Note 1.** The setting range and the default of the Inverter will differ depending on its capacity and control mode. (The value for the 200-V class 0.4 kW Inverter in open loop vector control mode will be displayed.)

**Note 2.** For a 400-V Inverter, if the carrier frequency is set to a value higher than the default setting, the Inverter overload “OL2” detection value will decrease.

■ Hunting Prevention: C7

| Constant No. | Name                         | Description   | Setting range | Default setting | Changes during operation | Control mode |             |                  |             | Page       |
|--------------|------------------------------|---|---------------|-----------------|--------------------------|--------------|-------------|------------------|-------------|------------|
|              | Display name                 |   |               |                 |                          | V/f control  | V/f with PG | Open loop vector | Flux vector |            |
| C7-01        | Hunting prevention selection | 0: Disabled<br>1: Enabled<br><br>Note: The hunting prevention function is used to stop a motor under a light load from hunting. This function is exclusively for the V/f control mode. When greater responsiveness than vibration control is required, set hunting prevention to “disabled.”  | 0, 1          | 1               | NO                       | A            | A           | X                | X           | 6-11, 6-33 |
|              | Hunt Prev Select             |   |               |                 |                          |              |             |                  |             |            |
| C7-02        | Hunting prevention gain      | Sets the ratio for hunting prevention gain.<br>Note: Usually setting is not necessary. Adjust in the following circumstances:<br>When vibration occurs due to a light load, increase the set values.<br>When the motor is stalled, decrease the set values.<br>If the set values become too large, the motor may stall as a result of non-controlled current. | 0.00 to 2.50  | 1.00            | NO                       | A            | A           | X                | X           | 6-11, 6-33 |
|              | Hunt Prev Gain               |   |               |                 |                          |              |             |                  |             |            |

■ Factory Tuning: C8

| Constant No. | Name   | Description  | Setting range | Default setting | Changes during operation | Control mode |             |                  |             | Page |
|--------------|--|--|---------------|-----------------|--------------------------|--------------|-------------|------------------|-------------|------|
|              | Display name                                   |  |               |                 |                          | V/f control  | V/f with PG | Open loop vector | Flux vector |      |
| C8-08        | AFR Gain                                       | Sets the internal speed feedback detection control section as a ratio.<br>Note: Usually setting is not necessary.<br>Adjust in the following circumstances:<br>When hunting occurs, increase the set values.<br>When responsiveness is low, decrease the set values.<br>Change the responsiveness in 0.05 units at a time, checking after each change. | 0.00 to 10.00 | 1.00            | NO                       | X            | X           | A                | X           | 6-5  |
|              | AFR Gain                                       |  |               |                 |                          |              |             |                  |             |      |
| C8-30        | Carrier Frequency Selection During Auto-tuning | Used to set the carrier frequency during Auto-tuning. Normally, this setting is not required.<br>0: Carrier frequency is set to 2.0 kHz.<br>1: Carrier frequency is set to a value as set in C6-01.<br>Note: Use this when Auto-tuning is not properly executed.<br>Set to "1" and execute at 5 kHz.   | 0, 1          | 0               | NO                       | X            | X           | A                | A           | ---  |
|              | Carrier in tune                                |  |               |                 |                          |              |             |                  |             |      |

### 7-2-3 Reference Parameters List

#### ■ Preset Reference: d1

| Constant No. | Name                    | Description  | Setting range        | Default setting | Changes during operation | Control mode |             |                  |             | Page |
|--------------|-------------------------|--|----------------------|-----------------|--------------------------|--------------|-------------|------------------|-------------|------|
|              | Display name            |  |                      |                 |                          | V/f control  | V/f with PG | Open loop vector | Flux vector |      |
| d1-01        | Frequency reference 1   | Sets the frequency reference in the units used in o1-03 (frequency reference display/set units.) The default setting unit for o1-03 is Hz. | 0 to max. frequency. | 6.00            | OK                       | Q            | Q           | Q                | Q           | 5-9  |
|              | Preset Reference 1      |  |                      |                 |                          |              |             |                  |             |      |
| d1-02        | Frequency reference 2   | The frequency reference when the multi-function input "multi-step speed reference 1" is ON.  |                      | 0.00            | OK                       | Q            | Q           | Q                | Q           | 5-9  |
|              | Preset Reference 2      |  |                      |                 |                          |              |             |                  |             |      |
| d1-03        | Frequency reference 3   | The frequency reference when the multi-function input "multi-step speed reference 2" is ON.  |                      | 0.00            | OK                       | Q            | Q           | Q                | Q           | 5-9  |
|              | Preset Reference 3      |  |                      |                 |                          |              |             |                  |             |      |
| d1-04        | Frequency reference 4   | The frequency reference when the multi-function input "multi-step speed reference 1, 2" is ON.   |                      | 0.00            | OK                       | Q            | Q           | Q                | Q           | 5-9  |
|              | Preset Reference 4      |  |                      |                 |                          |              |             |                  |             |      |
| d1-05        | Frequency reference 5   | The frequency reference when the multi-function input "multi-step speed reference 3" is ON.  |                      | 0.00            | OK                       | B            | B           | B                | B           | 5-9  |
|              | Preset Reference 5      |  |                      |                 |                          |              |             |                  |             |      |
| d1-06        | Frequency reference 6   | The frequency reference when the multi-function input "multi-step speed reference 1, 3" is ON.   | 0.00                 | OK              | B                        | B            | B           | B                | 5-9         |      |
|              | Preset Reference 6      |  |                      |                 |                          |              |             |                  |             |      |
| d1-07        | Frequency reference 7   | The frequency reference when the multi-function input "multi-step speed reference 2, 3" is ON.   | 0.00                 | OK              | B                        | B            | B           | B                | 5-9         |      |
|              | Preset Reference 7      |  |                      |                 |                          |              |             |                  |             |      |
| d1-08        | Frequency reference 8   | The frequency reference when the multi-function input "multi-step speed reference 1, 2, 3" is ON.  | 0.00                 | OK              | B                        | B            | B           | B                | 5-9         |      |
|              | Preset Reference 8      |  |                      |                 |                          |              |             |                  |             |      |
| d1-09        | Jog frequency reference | The reference frequency when the multi-function inputs, "Jog reference frequency selection," "FJOG command," and "RJOG command" are ON.    | 6.00                 | OK              | Q                        | Q            | Q           | Q                | 5-10        |      |
|              | Jog Reference           |  |                      |                 |                          |              |             |                  |             |      |

■ Reference Limits: d2

| Constant No. | Name                            | Description   | Setting range | Default setting | Changes during operation | Control mode |             |                  |             | Page |
|--------------|---------------------------------|---|---------------|-----------------|--------------------------|--------------|-------------|------------------|-------------|------|
|              | Display name                    |   |               |                 |                          | V/f control  | V/f with PG | Open loop vector | Flux vector |      |
| d2-01        | Reference frequency upper limit | Sets the output frequency upper limit as a percentage of the maximum frequency. | 0.0 to 110.0  | 100.0           | NO                       | B            | B           | B                | B           | 6-52 |
|              | Ref Upper Limit                 |   |               |                 |                          |              |             |                  |             |      |
| d2-02        | Reference frequency lower limit | Sets the output frequency lower limit as a percentage of the maximum frequency. | 0.0 to 109.0  | 0.0             | NO                       | B            | B           | B                | B           | 6-52 |
|              | Ref Lower Limit                 |   |               |                 |                          |              |             |                  |             |      |

■ Jump Frequencies: d3

| Constant No. | Name                 | Description   | Setting range | Default setting | Changes during operation | Control mode |             |                  |             | Page |
|--------------|----------------------|---|---------------|-----------------|--------------------------|--------------|-------------|------------------|-------------|------|
|              | Display name         |   |               |                 |                          | V/f control  | V/f with PG | Open loop vector | Flux vector |      |
| d3-01        | Jump frequency 1     | Sets the center value of the jump frequency in Hz.<br>Note: This function is disabled by setting the jump frequency to 0 Hz. Always ensure that the following applies:<br>$d3-01 \geq d3-02 \geq d3-03$<br>Operation in the jump frequency range is prohibited but during acceleration and deceleration, speed changes smoothly without jump. | 0.0 to 400.0  | 0.0             | NO                       | B            | B           | B                | B           | 6-52 |
|              | Jump Freq 1          |   |               |                 |                          |              |             |                  |             |      |
| d3-02        | Jump frequency 2     |   | 0.0           | NO              | B                        | B            | B           | B                | B           | 6-52 |
|              | Jump Freq 2          |   |               |                 |                          |              |             |                  |             |      |
| d3-03        | Jump frequency 3     |   | 0.0           | NO              | B                        | B            | B           | B                | B           | 6-52 |
|              | Jump Freq 3          |   |               |                 |                          |              |             |                  |             |      |
| d3-04        | Jump frequency width | Sets the jump frequency bandwidth in Hz.<br>Note: The jump frequency will be the jump frequency $\pm$ d3-04.  | 0.0 to 20.0   | 1.0             | NO                       | B            | B           | B                | B           | 6-52 |
|              | Jump Bandwidth       |   |               |                 |                          |              |             |                  |             |      |

■ Sequence for Reference: d4

| Constant No. | Name  | Description  | Setting range | Default setting | Changes during operation | Control mode |             |                  |             | Page |
|--------------|---|--|---------------|-----------------|--------------------------|--------------|-------------|------------------|-------------|------|
|              | Display name                                |  |               |                 |                          | V/f control  | V/f with PG | Open loop vector | Flux vector |      |
| d4-01        | Reference frequency hold function selection | Sets whether or not frequencies on hold will be recorded.<br>0: Disabled (when operation is stopped or the power is turned on again starts at 0.)<br>1: Enabled (when operation is stopped or the power is turned on again starts at the previous hold frequency.)<br><br>Note: This function is available when the multi-function inputs "accel/decel Ramp Hold" or "UP/DOWN" commands (MOP increase/decrease) are set. | 0, 1          | 0               | NO                       | A            | A           | A                | A           | 6-53 |
|              | MOP Ref Memory                              |  |               |                 |                          |              |             |                  |             |      |
| d4-02        | Trim control level                          | Sets the increase/decrease frequency for analog frequency references as a percentage of the maximum frequency.<br><br>Note: This function is available when the multi-function inputs "Trim Ctl Increase" or "Trim Ctl Decrease" is set.   | 0 to 100      | 25              | NO                       | A            | A           | A                | A           | 6-54 |
|              | Trim Control Lvl                            |  |               |                 |                          |              |             |                  |             |      |

■ Torque Control: d5

| Constant No. | Name                        | Description   | Setting range | Default setting | Changes during operation | Control mode |             |                  |             | Page       |
|--------------|-----------------------------|---|---------------|-----------------|--------------------------|--------------|-------------|------------------|-------------|------------|
|              | Display name                |   |               |                 |                          | V/f control  | V/f with PG | Open loop vector | Flux vector |            |
| d5-01        | Torque control selection    | 0: Speed control (C5-01 to C5-07)<br>1: Torque control<br><br>Note: This function is only available in flux vector control mode.<br>To use the function for switching between speed and torque control, set to 0 and set the multi-function input to "speed/torque control change." | 0, 1          | 0               | NO                       | X            | X           | X                | A           | 6-16, 6-23 |
|              | Torq Control Sel            |   |               |                 |                          |              |             |                  |             |            |
| d5-02        | Torque reference delay time | Sets the torque reference delay time in ms units.<br><br>Note: This function can be used to adjust the noise of the torque control signal or the responsiveness with the host controller. When vibration occurs during torque control, increase the set value.                      | 0 to 1000     | 0               | NO                       | X            | X           | X                | A           | 6-21       |
|              | Torq Ref Filter             |   |               |                 |                          |              |             |                  |             |            |

| Constant No. | Name                                  | Description   | Setting range | Default setting | Changes during operation | Control mode |             |                  |             | Page |
|--------------|---------------------------------------|---|---------------|-----------------|--------------------------|--------------|-------------|------------------|-------------|------|
|              | Display name                          |   |               |                 |                          | V/f control  | V/f with PG | Open loop vector | Flux vector |      |
| d5-03        | Speed limit selection                 | Sets the speed limit command method for the torque control mode.<br>1: The analog input limit from an analog frequency reference terminal (terminals 13 and 14.)<br>2: Limited to d5-04 parameter setting values.   | 1, 2          | 1               | NO                       | X            | X           | X                | A           | 6-18 |
|              | Speed Limit Sel                       |   |               |                 |                          |              |             |                  |             |      |
| d5-04        | Speed limit                           | Sets the speed limit during torque control as a percentage of the maximum frequency.<br>Note: This function is enabled when d5-03 is set to 2. Directions are as follows.<br>+: operation command direction<br>-: operation command opposite direction  | -120 to +120  | 0               | NO                       | X            | X           | X                | A           | 6-19 |
|              | Speed Lmt Value                       |   |               |                 |                          |              |             |                  |             |      |
| d5-05        | Speed limit bias                      | Sets the speed limit bias as a percentage of the maximum frequency.<br>Note: Bias is given to the specified speed limit. It can be used to adjust the margin for the speed limit.   | 0 to 120      | 10              | NO                       | X            | X           | X                | A           | 6-20 |
|              | Speed Lmt Bias                        |   |               |                 |                          |              |             |                  |             |      |
| d5-06        | Speed/torque control switching timer. | Sets the delay time from inputting the multi-function input "speed/torque control change" (from ON to OFF or OFF to ON) until the control is actually changed, in ms units.<br>Note: This function is enabled when the multi-function input "speed/torque control change" is set. In the speed/torque control switching timer, the three analog inputs hold the values of when the "speed/torque control change" changes. Always be sure to allow time for this process to finish completely. | 0 to 1000     | 0               | NO                       | X            | X           | X                | A           | 6-24 |
|              | Ref Hold Time                         |   |               |                 |                          |              |             |                  |             |      |

### 7-2-4 Motor Constant Parameter Lists

#### ■ V/f Pattern: E1

| Constant No. | Name                  | Description   | Setting range           | Default setting  | Changes during operation | Control mode |             |                  |             | Page                   |
|--------------|-----------------------|---|-------------------------|------------------|--------------------------|--------------|-------------|------------------|-------------|------------------------|
|              | Display name          |   |                         |                  |                          | V/f control  | V/f with PG | Open loop vector | Flux vector |                        |
| E1-01        | Input voltage setting | Sets the Inverter input voltage in units of 1 V.<br>Note: This setting is used as the reference value for functions such as the protection functions. | 155 to 255 (see note 1) | 200 (see note 1) | NO                       | Q            | Q           | Q                | Q           | 5-19, 5-22, 5-33, 5-41 |
|              | Input Voltage         |   |                         |                  |                          |              |             |                  |             |                        |



| Constant No. | Name                           | Description  | Setting range   | Default setting              | Changes during operation | Control mode |             |                  |             | Page       |      |
|--------------|--------------------------------|--|---|------------------------------|--------------------------|--------------|-------------|------------------|-------------|------------|------|
|              | Display name                   |  |   |                              |                          | V/f control  | V/f with PG | Open loop vector | Flux vector |            |      |
| E1-02        | Motor selection                | 0: Standard fan-cooled motor (general-purpose motor)<br>1: Standard blower-cooled motor (Inverter-exclusive motor) | 0, 1  | 0                            | NO                       | Q            | Q           | Q                | Q           | 5-22, 5-41 |      |
|              | Motor Selection                | Note: This setting is used as the reference value for functions such as the protection functions.                  |   |                              |                          |              |             |                  |             |            |      |
| E1-03        | V/f pattern selection          | 0 to E: Select from the 15 preset patterns.  | 0 to F  | F                            | NO                       | Q            | Q           | X                | X           | 5-23       |      |
|              | V/F Selection                  | F: Custom user-set patterns (Applicable for settings E1-04 to E1-10.)  |   |                              |                          |              |             |                  |             |            |      |
| E1-04        | Maximum frequency (FMAX)       | Output voltage (V)<br>   | 50.0 to 400.0   | 60.0                         | NO                       | Q            | Q           | Q                | Q           | 5-27       |      |
|              | Max Frequency                  |  |   |                              |                          |              |             |                  |             |            |      |
| E1-05        | Maximum voltage (VMAX)         |  | VC (E1-08)  | 0.0 to 255.0 (see note 1)    | 200.0 (see note 1)       | NO           | Q           | Q                | Q           | Q          | 5-27 |
|              | Max Voltage                    |  | VMIN (E1-10)  |                              |                          |              |             |                  |             |            |      |
| E1-06        | Maximum voltage frequency (FA) |  | Note: To set V/f characteristics in a straight line, set the same values for E1-07 and E1-09. In this case, the setting for E1-08 will be ignored.<br>Always ensure that the four frequencies are set in the following manner:<br>E1-04 (FMAX) ≥ E1-06 (FA) > E1-07 (FB) ≥ E1-09 (FMIN) | 0.0 to 400.0                 | 60.0                     | NO           | Q           | Q                | Q           | Q          | 5-27 |
|              | Base Frequency                 |  |   |                              |                          |              |             |                  |             |            |      |
| E1-07        | Intermediate frequency (FB)    |  |   | 0.0 to 400.0                 | 3.0 (see note 2)         | NO           | Q           | Q                | A           | X          | 5-27 |
|              | Mid Frequency A                |  |   |                              |                          |              |             |                  |             |            |      |
| E1-08        | Intermediate voltage (VC)      |  |   | 0.0 to 255.0 (see note 1, 2) | 11.0 (see note 1, 2)     | NO           | Q           | Q                | A           | X          | 5-27 |
|              | Mid Voltage A                  |  |   |                              |                          |              |             |                  |             |            |      |
| E1-09        | Minimum frequency (FMIN)       | 0.0 to 400.0   |   | 0.5 (see note 2)             | NO                       | Q            | Q           | Q                | A           | 5-27       |      |
|              | Min Frequency                  |  |   |                              |                          |              |             |                  |             |            |      |
| E1-10        | Minimum voltage (VMIN)         | 0.0 to 255.0 (see note 1)  |   | 2.0 (see note 1, 2)          | NO                       | Q            | Q           | A                | X           | 5-27       |      |
|              | Min Voltage                    |  |   |                              |                          |              |             |                  |             |            |      |

| Constant No. | Name<br>Display name            | Description  | Setting range | Default setting | Changes during operation | Control mode |             |                  |             | Page |
|--------------|---------------------------------|--|---------------|-----------------|--------------------------|--------------|-------------|------------------|-------------|------|
|              |                                 |  |               |                 |                          | V/f control  | V/f with PG | Open loop vector | Flux vector |      |
| E1-11        | Mid. Output Frequency B         | Used to set the middle frequency and voltage in the constant output area. Normally, this setting is not required.  | 0.0 to 400.0  | 0.0             | NO                       | A            | A           | A                | A           | ---  |
|              | Mid frequency B                 | Note: When using a high-speed motor, set the characteristics of the constant output area.  |               |                 |                          |              |             |                  |             |      |
| E1-12        | Mid. Output Frequency Voltage B | Output voltage (V)<br>VMA<br>E1-05<br>E1-12<br>E1-13<br>0  | 0.0 to 255.0  | 0.0             | NO                       | A            | A           | A                | A           | ---  |
|              | Mid voltage B                   | <p>The graph plots Output voltage (V) on the y-axis against Frequency (Hz) on the x-axis. A line starts at the origin (0,0) and passes through four points: FA (E1-06), E1-11, and FMAX (E1-04). The point E1-12 is also marked on the line between E1-06 and E1-11. Dashed lines connect these points to their respective values on the axes.</p> |               |                 |                          |              |             |                  |             |      |
| E1-13        | Base Voltage                    | Note: Set as follows:<br>E1-06 < E1-11 < E1-04.  | 0.0 to 255.0  | 200.0           | NO                       | A            | A           | Q                | Q           | ---  |
|              | Base voltage                    | Note: This parameter becomes disabled if E1-11 and E1-12 are set to "0."   |               |                 |                          |              |             |                  |             |      |

**Note 1.** These are values for a 200-V class Inverter. Values for the 400-V class Inverter are double.

**Note 2.** When the control mode is changed, the Inverter reverts to default settings. (The open loop vector control default settings will be displayed.)

■ Motor Setup: E2

| Constant No. | Name<br>Display name  | Description   | Setting range                 | Default setting       | Changes during operation | Control mode |             |                  |             | Page                           |
|--------------|-----------------------|---|-------------------------------|-----------------------|--------------------------|--------------|-------------|------------------|-------------|--------------------------------|
|              |                       |   |                               |                       |                          | V/f control  | V/f with PG | Open loop vector | Flux vector |                                |
| E2-01        | Motor rated current   | Sets the motor rated current in 1-A units.<br>Note: These set values will become the reference values for motor protection, torque limits and torque control. | 0.32 to 6.40<br>(See note 2.) | 1.90<br>(See note 1.) | NO                       | Q            | Q           | Q                | Q           | 5-22,<br>5-41,<br>6-7,<br>6-28 |
|              | Motor Rated FLA       | These values will automatically be set if they were set during auto-tuning.   |                               |                       |                          |              |             |                  |             |                                |
| E2-02        | Motor rated slip      | Sets the motor rated slip in Hz units.<br>Note: These set values will become the reference values for slip compensation.                                      | 0.00 to 20.00                 | 2.90<br>(See note 1.) | NO                       | A            | A           | Q                | Q           | 6-7,<br>6-12,<br>6-28          |
|              | Motor Rated Slip      | These values will be automatically set if auto-tuning is started.   |                               |                       |                          |              |             |                  |             |                                |
| E2-03        | Motor no-load current | Sets the motor no-load current in 1-A units.<br>Note: These values will be automatically set if auto-tuning is started.                                       | 0.00 to 1500.0                | 1.20<br>(See note 1.) | NO                       | A            | A           | Q                | Q           | 6-7,<br>6-12,<br>6-28          |
|              | No-Load Current       |   |                               |                       |                          |              |             |                  |             |                                |

| Constant No. | Name                                     | Description  | Setting range   | Default setting     | Changes during operation | Control mode |             |                  |             | Page            |
|--------------|--|--|-----------------|---------------------|--------------------------|--------------|-------------|------------------|-------------|-----------------|
|              | Display name                             |  |                 |                     |                          | V/f control  | V/f with PG | Open loop vector | Flux vector |                 |
| E2-04        | Number of motor poles                    | Sets the number of motor poles.<br>Note: These values will automatically be set if they were set during auto-tuning.   | 2 to 48         | 4                   | NO                       | X            | Q           | X                | Q           | 5-41, 6-28      |
|              | Number of Poles                          |  |                 |                     |                          |              |             |                  |             |                 |
| E2-05        | Motor phase-to-phase resistance          | Sets the motor phase-to-phase resistance in $\Omega$ units.<br>Note: These values will be automatically set if auto-tuning is started.   | 0.000 to 65.000 | 9.842 (See note 1.) | NO                       | A            | A           | A                | A           | 6-8, 6-12, 6-29 |
|              | Term Resistance                          |  |                 |                     |                          |              |             |                  |             |                 |
| E2-06        | Motor leakage inductance                 | Sets the voltage drop due to motor leakage inductance as a percentage of the motor rated voltage.<br>Note: These values will be automatically set if auto-tuning is started.   | 0.0 to 30.0     | 18.2 (See note 1.)  | NO                       | X            | X           | A                | A           | 6-8, 6-29       |
|              | Leak Inductance                          |  |                 |                     |                          |              |             |                  |             |                 |
| E2-07        | Motor iron-core saturation coefficient 1 | Sets the motor iron-core saturation coefficient at 50% of magnetic flux.<br>Note: These values will be automatically set if auto-tuning is started.  | 0.00 to 0.50    | 0.50                | NO                       | X            | X           | A                | A           | 6-8, 6-29       |
|              | Saturation Comp1                         |  |                 |                     |                          |              |             |                  |             |                 |
| E2-08        | Motor iron-core saturation coefficient 2 | Sets the motor iron-core saturation coefficient at 75% of magnetic flux.<br>Note: These values will be automatically set if auto-tuning is started.  | 0.00 to 0.75    | 0.75                | NO                       | X            | X           | A                | A           | 6-8, 6-29       |
|              | Saturation Comp2                         |  |                 |                     |                          |              |             |                  |             |                 |
| E2-09        | Mechanical loss                          | Sets motor mechanical loss as a percentage of motor rated output (W).<br>Note: Usually setting is not necessary. Adjust in the following circumstances:<br>When torque loss is large due to motor bearing.<br>When the torque loss in the pump or fan is large.<br>The set mechanical loss will compensate for torque. | 0.0 to 10.0     | 0.0                 | NO                       | X            | X           | X                | A           | 6-29            |
|              | Mechanical Loss                          |  |                 |                     |                          |              |             |                  |             |                 |

**Note 1.** The default setting depends upon the type of Inverter. The values for a 200-V class 0.4 kW Inverter will be displayed.

**Note 2.** The setting range is 10 to 200% of the Inverter’s rated output current. The values for a 200-V class 0.4 kW Inverter will be displayed.

■ Motor 2 Setup: E3 to E5

| Con-stant No. | Name                              | Description  | Setting range  | Default setting | Changes during operation | Control mode |             |                  |             |
|---------------|-----------------------------------|--|----------------|-----------------|--------------------------|--------------|-------------|------------------|-------------|
|               | Display name                      |  |                |                 |                          | V/f control  | V/f with PG | Open loop vector | Flux vector |
| E3-01         | Select control method of motor 2  | Sets the control method of motor 2 when used for two-motor switching control.<br>0: V/f control<br>2: Open loop vector                         | 0, 2           | 2               | NO                       | A            | A           | A                | A           |
|               | Control Method                    | Note: Enabled when the motor 2 selection function is set for multi-function input.   |                |                 |                          |              |             |                  |             |
| E4-01         | Motor 2 maximum frequency         | Sets the motor constants of motor 2, when used for two-motor switching   | 40.0 to 400.0  | 60.0            | NO                       | A            | A           | A                | A           |
|               | V/F2 Max Freq.                    | Note 1: Enabled when the motor 2 selection function is set for multi-function input.   |                |                 |                          |              |             |                  |             |
| E4-02         | Motor 2 maximum frequency         | Note 2: Set like E1-04 to E2-06.   | 0.0 to 255.0   | 200             | NO                       | A            | A           | A                | A           |
|               | V/F2 Max Voltage                  | Note 3: Changes motors after Inverter and motor stop.  |                |                 |                          |              |             |                  |             |
| E4-03         | Motor 2 maximum voltage frequency | Note 4: Waits to change motor for 20 to 50 ms after Inverter input.  | 0.0 to 400.0   | 60.0            | NO                       | A            | A           | A                | A           |
|               | V/F2 Base Freq.                   | Note 5: Cannot use motor 1 parameters and motor 2 parameters at same time.   |                |                 |                          |              |             |                  |             |
| E4-04         | Motor 2 intermediate frequency    | Note 6: Motor selection signal will be enabled when the motor 2 selected function is set for multi-function output.                            | 0.0 to 400.0   | 3.0             | NO                       | A            | A           | A                | X           |
|               | V/F2 Mid Freq.                    | Note 7: If the control method for motor 1 is different from that for motor 2, all other parameters of motor 2 will be set to default settings. |                |                 |                          |              |             |                  |             |
| E4-05         | Motor 2 intermediate voltage      | Note 7: If the control method for motor 1 is different from that for motor 2, all other parameters of motor 2 will be set to default settings. | 0.0 to 255.0   | 11.0            | NO                       | A            | A           | A                | X           |
|               | V/F2 Mid Voltage                  |  |                |                 |                          |              |             |                  |             |
| E4-06         | Motor 2 minimum frequency         |  | 0.0 to 400.0   | 0.5             | NO                       | A            | A           | A                | A           |
|               | V/F2 Min Freq.                    |  |                |                 |                          |              |             |                  |             |
| E4-07         | Motor 2 minimum voltage           |  | 0.0 to 255.0   | 2.0             | NO                       | A            | A           | A                | X           |
|               | V/F2 Min Voltage                  |  |                |                 |                          |              |             |                  |             |
| E5-01         | Motor 2 rated current             |  | 0.01 to 1500.0 | 1.90            | NO                       | A            | A           | A                | A           |
|               | Motor2 Rated FLA                  |  |                |                 |                          |              |             |                  |             |
| E5-02         | Motor 2 rated slip                |  | 0.00 to 20.00  | 2.90            | NO                       | A            | A           | A                | A           |
|               | Motor2 Slip Freq                  |  |                |                 |                          |              |             |                  |             |

| Constant No. | Name                              | Description   | Setting range   | Default setting | Changes during operation | Control mode |             |                  |             |
|--------------|-----------------------------------|---|-----------------|-----------------|--------------------------|--------------|-------------|------------------|-------------|
|              | Display name                      |   |                 |                 |                          | V/f control  | V/f with PG | Open loop vector | Flux vector |
| E5-03        | Motor 2 no-load current           | Sets the motor constants of motor 2, when used for two-motor switching<br>Note 1: Enabled when the motor 2 selection function is set for multi-function input.                                    | 0.01 to 1500.0  | 1.20            | NO                       | A            | A           | A                | A           |
|              | Motor2 No-Load                    |   |                 |                 |                          |              |             |                  |             |
| E5-04        | Motor 2 number of motor poles     | Note 2: Set like E1-04 to E2-06.<br>Note 3: Changes motors after Inverter and motor stop.<br>Note 4: Waits to change motor for 20 to 50 ms after Inverter input.                                  | 2 to 48         | 4               | NO                       | A            | A           | A                | A           |
|              | Motor2 # Poles                    |   |                 |                 |                          |              |             |                  |             |
| E5-05        | Motor 2 phase-to-phase resistance | Note 5: Cannot use motor 1 parameters and motor 2 parameters at same time.<br>Note 6: Motor selection signal will be enabled when the motor 2 selected function is set for multi-function output. | 0.000 to 65.000 | 9.842           | NO                       | A            | A           | A                | A           |
|              | Motor2 Term Ohms                  |   |                 |                 |                          |              |             |                  |             |
| E5-06        | Motor 2 leakage inductance        | Note 7: If the control method for motor 1 is different from that for motor 2, all other parameters of motor 2 will be set to default settings.  | 0.0 to 30.0     | 18.2            | NO                       | A            | A           | A                | A           |
|              | Motor2 Leak                       |   |                 |                 |                          |              |             |                  |             |

### 7-2-5 Options Parameter Lists

#### ■ PG Option Setup: F1

| Constant No. | Name                                   | Description   | Setting range | Default setting | Changes during operation | Control mode |             |                  |             | Page       |
|--------------|--|---|---------------|-----------------|--------------------------|--------------|-------------|------------------|-------------|------------|
|              | Display name                           |   |               |                 |                          | V/f control  | V/f with PG | Open loop vector | Flux vector |            |
| F1-01        | Number of PG pulses                    | Sets the number of PG (pulse generator or encoder) pulses.<br>Note: Sets the number of pulses per motor revolution.   | 0 to 60000    | 1000            | NO                       | X            | Q           | X                | Q           | 5-28, 5-43 |
|              | PG Pulses/Rev                          |   |               |                 |                          |              |             |                  |             |            |
| F1-02        | PG disconnection stopping method (PGO) | Sets the PG disconnection stopping method.<br>0: Ramp to stop (Deceleration stop using deceleration time 1, C1-02.)<br>1: Coast to stop<br>2: Fast stop (Emergency stop using the fast-stop time, C1-09.)<br>3: Continue operation (This setting can't be made with flux vector control.) | 0 to 3        | 1               | NO                       | X            | B           | X                | B           | 5-30, 5-44 |
|              | PG Fdbk Loss Sel                       |   |               |                 |                          |              |             |                  |             |            |

| Constant No. | Name<br>Display name                           | Description  | Setting range | Default setting | Changes during operation | Control mode |             |                  |             | Page       |
|--------------|--|--|---------------|-----------------|--------------------------|--------------|-------------|------------------|-------------|------------|
|              |  |  |               |                 |                          | V/f control  | V/f with PG | Open loop vector | Flux vector |            |
| F1-03        | PG overspeed stopping method                   | Sets the stopping method when an overspeed (OS) fault occurs.<br>0: Ramp to stop (Deceleration stop using deceleration time 1, C1-02.)<br>1: Coast to stop<br>2: Fast stop (Emergency stop using the fast-stop time, C1-09.)<br>3: Continue operation (This setting can't be made with flux vector control.)                               | 0 to 3        | 1               | NO                       | X            | B           | X                | B           | 5-30, 5-44 |
|              | PG OverSpeed Sel                               |  |               |                 |                          |              |             |                  |             |            |
| F1-04        | PG speed deviation stopping method             | Sets the stopping method when a speed deviation (DEV) fault occurs.<br>0: Ramp to stop (Deceleration stop using deceleration time 1, C1-02.)<br>1: Coast to stop<br>2: Fast stop (Emergency stop using the fast-stop time, C1-09.)<br>3: Continue operation (DEV is displayed and control continued.)                                      | 0 to 3        | 3               | NO                       | X            | B           | X                | B           | 5-31, 5-45 |
|              | PG Deviation Sel                               |  |               |                 |                          |              |             |                  |             |            |
| F1-05        | PG rotation setting                            | 0: Phase A leads with forward command. (Phase B leads with reverse command.)<br>1: Phase B leads with forward command. (Phase A leads with reverse command.)   | 0, 1          | 0               | NO                       | X            | B           | X                | B           | 5-29       |
|              | PG Rotation Sel                                |  |               |                 |                          |              |             |                  |             |            |
| F1-06        | PG output ratio                                | Sets the division ratio for the PG speed control card pulse output.<br>Division ratio = $(1 + n) / m$ ( $n=0, 1$<br>$m=1$ to 32)<br><br><div style="text-align: center;"> <p>F1 - 06 = <input type="text"/> <input type="text"/> <input type="text"/></p> <p style="margin-left: 100px;">m</p> <p style="margin-left: 100px;">n</p> </div> | 1 to 132      | 1               | NO                       | X            | B           | X                | B           | 5-29       |
|              | PG Output Ratio                                |  |               |                 |                          |              |             |                  |             |            |
| F1-07        | Selecting integral control during accel/decel. | Sets integral control during acceleration/deceleration to either enabled or disabled.<br>0: Disabled (The integral function isn't used while accelerating or decelerating; it is used at constant speeds.)<br>1: Enabled (The integral function is used at all times.)   | 0, 1          | 0               | NO                       | X            | B           | X                | X           | 5-44       |
|              | PG Ramp PI/I Sel                               |  |               |                 |                          |              |             |                  |             |            |

| Constant No. | Name                                     | Description  | Setting range | Default setting | Changes during operation | Control mode |             |                  |             | Page       |
|--------------|--|--|---------------|-----------------|--------------------------|--------------|-------------|------------------|-------------|------------|
|              | Display name                             |  |               |                 |                          | V/f control  | V/f with PG | Open loop vector | Flux vector |            |
| F1-08        | Overspeed (OS) detection level.          | Sets the overspeed detection method. Frequencies above that set for F1-08 (set as a percentage of the maximum frequency), which continue to exceed this frequency for the detection time (F1-09), are detected as overspeed faults.  | 0 to 120      | 115             | NO                       | X            | A           | X                | A           | 5-30, 5-45 |
|              | PG Overspd Level                         |  |               |                 |                          |              |             |                  |             |            |
| F1-09        | Overspeed (OS) detection time            |  | 0.0 to 2.0    | 0.0 (See note.) | NO                       | X            | A           | X                | A           | 5-30, 5-45 |
|              | PG Overspd Time                          |  |               |                 |                          |              |             |                  |             |            |
| F1-10        | PG speed deviation detection level (DEV) | Sets the speed deviation detection method. Any speed deviation above the F1-10 set level (set as a percentage of the maximum frequency), which continues for the deviation detection time (F1-11) is detected as a speed deviation.<br>Note: Speed deviation is the difference between actual motor speed and the reference command speed. | 0 to 50       | 10              | NO                       | X            | A           | X                | A           | 5-31, 5-46 |
|              | PG Deviate Level                         |  |               |                 |                          |              |             |                  |             |            |
| F1-11        | PG speed deviation detection time (DEV)  |  | 0.0 to 10.0   | 0.5             | NO                       | X            | A           | X                | A           | 5-31, 5-46 |
|              | PG Deviate Time                          |  |               |                 |                          |              |             |                  |             |            |
| F1-12        | Number of PG gear teeth 1                | Sets the number of teeth on the gears if there are gears between the PG and the motor.<br><br>Motor speed (r/min) = [No. of pulses input from PG x 60/No. of PG pulses (F1-01)] x [(F1-13)/(F1-12)]  | 0 to 1000     | 0               | NO                       | X            | A           | X                | X           | 5-43       |
|              | PG # Gear Teeth1                         |  |               |                 |                          |              |             |                  |             |            |
| F1-13        | Number of PG gear teeth 2                | Note: A gear ratio of 1 will be used if either of these parameters is set to 0.  |               | 0               | NO                       | X            | A           | X                | X           | 5-43       |
|              | PG # Gear Teeth2                         |  |               |                 |                          |              |             |                  |             |            |
| F1-14        | PG Disconnection Detection Time          | Used to set the PG disconnection detection time. PGO will be detected if the detection time continues beyond the set time.   | 0 to 10.0     | 2.0             | NO                       | X            | A           | X                | A           | ---        |
|              | PGO Time                                 |  |               |                 |                          |              |             |                  |             |            |

**Note** The setting range will change when the control mode is changed. (The setting range for Open loop vector control will be displayed.)

■ Other Options Setup: F2 to F9

| Constant No. | Name                                   | Description   | Setting range | Default setting | Changes during operation | Control mode |             |                  |             | Page |
|--------------|--|---|---------------|-----------------|--------------------------|--------------|-------------|------------------|-------------|------|
|              | Display name                           |   |               |                 |                          | V/f control  | V/f with PG | Open loop vector | Flux vector |      |
| F2-01        | Analog Reference Card selection        | Sets the functions for channel 1 to 3 which are effective when the 3G3IV-PAI14B Analog Reference Card is used.<br>0: 3-channel individual (Channel 1: terminal 13, Channel 2: terminal 14, Channel 3: terminal 16)<br>1: 3-channel addition (Addition values are the frequency reference)<br>Note: When set to 0, select 1 for b1-01. In this case the multi-function input "Option/Inverter selection" cannot be used.   | 0, 1          | 0               | NO                       | B            | B           | B                | B           | 6-55 |
|              | AI-14 Input Sel                        |   |               |                 |                          |              |             |                  |             |      |
| F3-01        | Digital Reference Card input selection | Sets the Digital Reference Card input method.<br>0: BCD 1% unit<br>1: BCD 0.1% unit<br>2: BCD 0.01% unit<br>3: BCD 1 Hz unit<br>4: BCD 0.1 Hz unit<br>5: BCD 0.01 Hz unit<br>6: BCD special setting (5-digit input)<br>7: Binary input<br>Note: 6 is only effective when the 3G3FV-PDI16H2 is used.   | 0 to 7        | 0               | NO                       | B            | B           | B                | B           | 6-55 |
|              | DI Input                               |   |               |                 |                          |              |             |                  |             |      |
| F4-01        | Channel 1 output monitor selection     | Effective when the Analog Monitor Card is used.<br>Monitor selection: Set the number of the monitor item to be output. (U1-□□)<br>Gain: Set the multiple of 10 V for outputting monitor items.<br>Note: 4, 10, 11, 12, 13, 14, 25, 28 cannot be set. 29 to 31 are not used. When the 3G3IV-PAO12 is used outputs of ± 10 V are possible. In this case, set H4-07 (select multi-function analog output signal level) to 1. When the 3G3IV-PAO08 is used, only outputs of 0 to 10 V are possible. | 1 to 31       | 2               | NO                       | B            | B           | B                | B           | 6-56 |
|              | AO Ch1 Select                          |   |               |                 |                          |              |             |                  |             |      |
| F4-02        | Channel 1 gain                         |   | 0.00 to 2.50  | 1.00            | OK                       | B            | B           | B                | B           | 6-56 |
|              | AO Ch1 Gain                            |   |               |                 |                          |              |             |                  |             |      |
| F4-03        | Channel 2 output monitor selection     |   | 1 to 31       | 3               | NO                       | B            | B           | B                | B           | 6-56 |
|              | AO Ch2 Select                          |   |               |                 |                          |              |             |                  |             |      |
| F4-04        | Channel 2 gain                         |   | 0.00 to 2.50  | 0.50            | OK                       | B            | B           | B                | B           | 6-56 |
|              | AO Ch2 Gain                            |   |               |                 |                          |              |             |                  |             |      |
| F5-01        | Not used                               | Do not set.   | ---           | 0               | ---                      | ---          | ---         | ---              | ---         | ---  |
|              | DO-02 Ch1 Select                       |   |               |                 |                          |              |             |                  |             |      |
| F5-02        | Not used                               | Do not set.   | ---           | 1               | ---                      | ---          | ---         | ---              | ---         | ---  |
|              | DO-02 Ch2 Select                       |   |               |                 |                          |              |             |                  |             |      |
| F6-01        | Not used                               | Do not set.   | ---           | 0               | ---                      | ---          | ---         | ---              | ---         | ---  |
|              | DO-08 Selection                        |   |               |                 |                          |              |             |                  |             |      |



| Constant No. | Name                            | Description  | Setting range | Default setting | Changes during operation | Control mode |             |                  |             | Page |
|--------------|---------------------------------|--|---------------|-----------------|--------------------------|--------------|-------------|------------------|-------------|------|
|              | Display name                    |  |               |                 |                          | V/f control  | V/f with PG | Open loop vector | Flux vector |      |
| F7-01        | Output pulse multiple selection | Effective when the Pulse Monitor Card is used. Sets the number of output pulses. 0: 1F, 1: 6F, 2: 10F, 3: 12F, 4: 36F<br>Note: F= the output frequency displayed in Hz.<br>Example: When 0 (1F) is set, and the output frequency is 60 Hz, 60 pulses per second are output. (50% duty) | 0 to 4        | 1               | NO                       | B            | B           | B                | B           | 6-57 |
|              | PO-36F Selection                |  |               |                 |                          |              |             |                  |             |      |
| F8-01        | Not used.                       | Do not set.  | ---           | 1               | ---                      | ---          | ---         | ---              | ---         | ---  |
|              | E-15 Det Sel                    |  |               |                 |                          |              |             |                  |             |      |
| F9-01        | Not used.                       | Do not set.  | ---           | 0               | ---                      | ---          | ---         | ---              | ---         | ---  |
|              | EFO Selection                   |  |               |                 |                          |              |             |                  |             |      |
| F9-02        | Not used.                       | Do not set.  | ---           | 0               | ---                      | ---          | ---         | ---              | ---         | ---  |
|              | FO Dtgt Sel                     |  |               |                 |                          |              |             |                  |             |      |
| F9-03        | Not used.                       | Do not set.  | ---           | 1               | ---                      | ---          | ---         | ---              | ---         | ---  |
|              | EFO Fault Sel                   |  |               |                 |                          |              |             |                  |             |      |
| F9-04        | Not used.                       | Do not set.  | ---           | 0               | ---                      | ---          | ---         | ---              | ---         | ---  |
|              | Trace Sample Tim                |  |               |                 |                          |              |             |                  |             |      |

## 7-2-6 Terminal Parameter Lists

## ■ Digital Inputs: H1

| Constant No. | Name   | Description    | Setting range | Default setting      | Changes during operation | Control mode |             |                  |             | Page |
|--------------|--|----------------|---------------|----------------------|--------------------------|--------------|-------------|------------------|-------------|------|
|              | Display name                                 |                |               |                      |                          | V/f control  | V/f with PG | Open loop vector | Flux vector |      |
| H1-01        | Multi-function input 1: Terminal 3 selection | Terminal 3 Sel | 0 to 77       | 24                   | NO                       | B            | B           | B                | B           | 6-59 |
| H1-02        | Multi-function input 2: Terminal 4 selection | Terminal 4 Sel | 0 to 77       | 14                   | NO                       | B            | B           | B                | B           | 6-59 |
| H1-03        | Multi-function input 3: Terminal 5 selection | Terminal 5 Sel | 0 to 77       | 3 (0)<br>(See note.) | NO                       | B            | B           | B                | B           | 6-59 |
| H1-04        | Multi-function input 4: Terminal 6 selection | Terminal 6 Sel | 0 to 77       | 4 (3)<br>(See note.) | NO                       | B            | B           | B                | B           | 6-59 |
| H1-05        | Multi-function input 5: Terminal 7 selection | Terminal 7 Sel | 0 to 77       | 6 (4)<br>(See note.) | NO                       | B            | B           | B                | B           | 6-59 |
| H1-06        | Multi-function input 6: Terminal 8 selection | Terminal 8 Sel | 0 to 77       | 8 (6)<br>(See note.) | NO                       | B            | B           | B                | B           | 6-59 |

**Note** The values in parentheses indicate initial values when initialized in 3-wire sequence.

## ● Digital Input Functions List

| Setting value | Function  | Control mode |          |                  |             | Page |
|---------------|---|--------------|----------|------------------|-------------|------|
|               |   | V/f          | V/f w/PG | Open loop Vector | Flux vector |      |
| 0             | 3-wire control (Forward/Reverse command)  | OK           | OK       | OK               | OK          | 5-15 |
| 1             | Local/Remote selection (ON: Operating, OFF: Setting constants)  | OK           | OK       | OK               | OK          | 6-60 |
| 2             | Option/Inverter selection (ON: Option)  | OK           | OK       | OK               | OK          | 6-60 |
| 3             | Multi-step speed reference 1<br>When H3-05 is set to "0," this function is combined with "Main/auxiliary speed switch." | OK           | OK       | OK               | OK          | 5-16 |
| 4             | Multi-step speed reference 2  | OK           | OK       | OK               | OK          | 5-16 |
| 5             | Multi-step speed reference 3  | OK           | OK       | OK               | OK          | 5-16 |
| 6             | Jog frequency reference (has priority over multi-step speed)  | OK           | OK       | OK               | OK          | 5-16 |
| 7             | Multi-accel/decel time 1  | OK           | OK       | OK               | OK          | 5-17 |
| 8             | Baseblock NO (contact a: Base block ON)   | OK           | OK       | OK               | OK          | 6-60 |
| 9             | Baseblock NC (contact b: Base block OFF)  | OK           | OK       | OK               | OK          | 6-60 |
| A             | Accel/decel ramp hold (ON: Accel/decel stopped, frequency on hold)  | OK           | OK       | OK               | OK          | 6-61 |
| B             | OH2 alarm signal input (ON: OH2 will be displayed)  | OK           | OK       | OK               | OK          | 6-62 |

| Setting value | Function  | Control mode |          |                  |             | Page |
|---------------|---|--------------|----------|------------------|-------------|------|
|               |   | V/f          | V/f w/PG | Open loop Vector | Flux vector |      |
| C             | Multi-function analog input selection (ON: Enable)  | OK           | OK       | OK               | OK          | 6-62 |
| D             | V/f mode selection (ON: Speed feedback control disabled, (normal V/f control))  | ---          | OK       | ---              | ---         | 6-62 |
| E             | Speed control integral reset (ON: Integral control disabled)  | ---          | OK       | ---              | OK          | 6-62 |
| F             | Not used: Do not set  | ---          | ---      | ---              | ---         | ---  |
| 10            | UP command "MOP Increase" (Always set with the DOWN command)  | OK           | OK       | OK               | OK          | 6-62 |
| 11            | DOWN command "MOP Decrease" (Always set with the UP command)  | OK           | OK       | OK               | OK          | 6-62 |
| 12            | FJOG command (ON: Forward rotation for jog frequency d1-09)   | OK           | OK       | OK               | OK          | 5-18 |
| 13            | RJOG command (ON: Reverse rotation for jog frequency d1-09)   | OK           | OK       | OK               | OK          | 5-18 |
| 14            | Fault reset (Reset when turned ON)  | OK           | OK       | OK               | OK          | 6-64 |
| 15            | Emergency stop "Fast-stop" (ON: Deceleration stop in emergency stop time C1-09)   | OK           | OK       | OK               | OK          | 5-18 |
| 16            | Motor 2 selection: Selection of motor 1 or motor 2 for two-motor switching control (ON: Motor 2 selected)   | OK           | OK       | OK               | OK          | ---  |
| 18            | Timer function input (Functions are set with b4-01, b4-02 and the timer function is set at the same time)   | OK           | OK       | OK               | OK          | 6-39 |
| 19            | PID control ON/OFF (ON: PID control disabled)   | OK           | OK       | OK               | OK          | 6-64 |
| 1A            | Multi-accel/decel time 2  | OK           | OK       | OK               | OK          | 5-17 |
| 1B            | Program lockout (OFF: All parameter constants other than frequency monitor are write protected.)  | OK           | OK       | OK               | OK          | 6-65 |
| 1C            | Trim control increase (ON: d4-02 frequencies are added to analog frequency references.)   | OK           | OK       | OK               | OK          | 6-65 |
| 1D            | Trim control decrease (ON: d4-02 frequencies are subtracted from analog frequency references.)  | OK           | OK       | OK               | OK          | 6-65 |
| 1F            | Frequency reference terminal 13/14 selection (ON: select terminal 14)   | OK           | OK       | OK               | OK          | 5-18 |
| 20 to 2F      | External fault (Desired settings possible)<br>Input mode: contact a/contact b,<br>Detection mode: Normal/during operation<br>Stopping method: Ramp to stop, coast to stop, fast stop or continue operation. | OK           | OK       | OK               | OK          | 6-66 |
| 60            | DC injection braking command (ON: DC operation)   | OK           | OK       | OK               | OK          | 6-68 |
| 61            | External speed search command 1: Maximum frequency (ON: speed search)   | OK           | ---      | OK               | ---         | 6-68 |
| 62            | External speed search command 2: Set frequency (ON: speed search)   | OK           | ---      | OK               | ---         | 6-68 |
| 63            | Energy save mode (ON: Energy-saving control set for b8-01, b8-02)   | OK           | OK       | ---              | ---         | 6-10 |
| 64 to 66      | Not used. Do not set.   | ---          | ---      | ---              | ---         | ---  |
| 71            | Speed/torque control change (ON: Torque control)  | ---          | ---      | ---              | OK          | 6-69 |

| Setting value | Function   | Control mode |          |                  |             | Page |
|---------------|--|--------------|----------|------------------|-------------|------|
|               |  | V/f          | V/f w/PG | Open loop Vector | Flux vector |      |
| 72            | Zero-servo command (ON: Zero-servo lock)                 | ---          | ---      | ---              | OK          | 6-69 |
| 77            | Speed control (ASR) proportional gain switch (ON: C5-03) | ---          | ---      | ---              | OK          | 6-69 |

■ Digital Outputs: H2

| Constant No. | Name   | Description          | Setting range | Default setting | Changes during operation | Control mode |             |                  |             | Page |
|--------------|--|----------------------|---------------|-----------------|--------------------------|--------------|-------------|------------------|-------------|------|
|              | Display name                                     |                      |               |                 |                          | V/f control  | V/f with PG | Open loop vector | Flux vector |      |
| H2-01        | Multi-function contact output: terminal 9 to 10. | Terminal 9 to 10 Sel | 0 to 37       | 0               | NO                       | B            | B           | B                | B           | 6-71 |
| H2-02        | Multi-function output 1: terminal 25.            | Terminal 25 Sel      | 0 to 37       | 1               | NO                       | B            | B           | B                | B           | 6-71 |
| H2-03        | Multi-function output 2: terminal 26.            | Terminal 26 Sel      | 0 to 37       | 2               | NO                       | B            | B           | B                | B           | 6-71 |

● Digital Outputs List

| Setting value |   | Control mode |          |                  |             | Page |
|---------------|---|--------------|----------|------------------|-------------|------|
|               |   | V/f          | V/f w/PG | Open loop Vector | Flux vector |      |
| 0             | During run 1  | OK           | OK       | OK               | OK          | 6-72 |
| 1             | Excitation  | OK           | OK       | OK               | OK          | 6-72 |
| 2             | Frequency (ref/out) agree 1: detection width L4-02  | OK           | OK       | OK               | OK          | 6-84 |
| 3             | Desired frequency (ref/setting) agree 1 (ON: Output frequency = ±L4-01, detection width L4-02)                | OK           | OK       | OK               | OK          | 6-84 |
| 4             | Frequency detection 1 (ON: +L4-01 ≥ output frequency ≥ -L4-01, detection width L4-02)                         | OK           | OK       | OK               | OK          | 6-84 |
| 5             | Frequency detection 2 (ON: Output frequency ≥ +L4-01 or output frequency ≤ -L4-01, detection width L4-02)     | OK           | OK       | OK               | OK          | 6-84 |
| 6             | Inverter operation ready<br>READY: After initialization, no faults  | OK           | OK       | OK               | OK          | ---  |
| 7             | During DC bus low voltage (UV) detection  | OK           | OK       | OK               | OK          | ---  |
| 8             | During baseblock 1 (ON: during baseblock)   | OK           | OK       | OK               | OK          | ---  |
| 9             | Operation reference (ON: Operator)  | OK           | OK       | OK               | OK          | ---  |
| A             | Run command remote operation (ON: Operator)   | OK           | OK       | OK               | OK          | ---  |
| B             | Overtorque detection 1 NO (contact a: ON, overtorque detection)   | OK           | OK       | OK               | OK          | 6-88 |
| C             | Loss of frequency reference (Effective when operation selection is "1" for L4-05 frequency reference missing) | OK           | OK       | OK               | OK          | 6-85 |

| Setting value |  | Control mode |          |                  |             | Page |
|---------------|--|--------------|----------|------------------|-------------|------|
|               |  | V/f          | V/f w/PG | Open loop Vector | Flux vector |      |
| D             | DB overheat (ON: Resistance overheat or braking Tr fault)  | OK           | OK       | OK               | OK          | ---  |
| E             | Fault (ON: Faults other than CPF00, CPF01 have occurred.)  | OK           | OK       | OK               | OK          | 8-1  |
| F             | Not used. Do not set   | ---          | ---      | ---              | ---         | ---  |
| 10            | Minor fault (ON:Report displayed)  | OK           | OK       | OK               | OK          | 8-7  |
| 11            | Fault reset command active   | OK           | OK       | OK               | OK          | ---  |
| 12            | Timer output   | OK           | OK       | OK               | OK          | 6-39 |
| 13            | Frequency (ref/out) agree 2 (Detection width: L4-04)   | OK           | OK       | OK               | OK          | 6-84 |
| 14            | Desired frequency (ref/setting) agree 2 (ON: Output frequency = L4-03, detection width L4-04)    | OK           | OK       | OK               | OK          | 6-84 |
| 15            | Frequency detection 3 (ON: output frequency $\leq$ -L4-03, detection width L4-04)                | OK           | OK       | OK               | OK          | 6-84 |
| 16            | Frequency detection 4 (ON: output frequency $\geq$ -L4-03, detection width L4-04)                | OK           | OK       | OK               | OK          | 6-84 |
| 17            | Overtorque detection 1 NC (Contact b: OFF, torque detection)                                     | OK           | OK       | OK               | OK          | 6-88 |
| 18            | Overtorque detection 2 NO (Contact a: ON, torque detection)                                      | OK           | OK       | OK               | OK          | 6-88 |
| 19            | Overtorque detection 2 NC (Contact b: OFF, torque detection)                                     | OK           | OK       | OK               | OK          | 6-88 |
| 1A            | During reverse run (ON: during reverse run)  | OK           | OK       | OK               | OK          | ---  |
| 1B            | During baseblock 2 (OFF: During base block)  | OK           | OK       | OK               | OK          | ---  |
| 1C            | Motor 2 selected (ON: motor 2 selected)  | OK           | OK       | OK               | OK          | ---  |
| 1D            | Regenerating (ON: Regenerating)  | ---          | ---      | ---              | OK          | ---  |
| 1E            | Restart enabled (ON: Restart enabled)  | OK           | OK       | OK               | OK          | 6-87 |
| 1F            | Motor overload (OL1) pre-alarm (ON: 90% or more of the detection level)                          | OK           | OK       | OK               | OK          | 6-72 |
| 20            | Inverter overheat (OH) pre-alarm (ON: Temperature is above L8-02)                                | OK           | OK       | OK               | OK          | 6-72 |
| 30            | During torque limit (current limit) (ON: During torque limit)                                    | ---          | ---      | OK               | OK          | ---  |
| 31            | During speed limit. (ON: During speed limit)   | ---          | ---      | ---              | OK          | ---  |
| 33            | Zero-servo end (ON: Zero-servo)  | ---          | ---      | ---              | OK          | 6-73 |
| 37            | During run 2 (ON: Frequency output, OFF: Base block, DC braking, initialization, operation stop. | OK           | OK       | OK               | OK          | 6-72 |

■ Analog Inputs: H3

| Constant No. | Name  | Description  | Setting range    | Default setting | Changes during operation | Control mode |             |                  |             | Page      |
|--------------|---|--|------------------|-----------------|--------------------------|--------------|-------------|------------------|-------------|-----------|
|              | Display name  |  |                  |                 |                          | V/f control  | V/f with PG | Open loop vector | Flux vector |           |
| H3-01        | Signal selection: terminal 13 (Voltage)                   | 0: 0 to +10 V<br>1: 0 to ±10 V   | 0, 1             | 0               | NO                       | B            | B           | B                | B           | 5-5       |
|              | Term 13 Signal  |  |                  |                 |                          |              |             |                  |             |           |
| H3-02        | Gain: terminal 13   | Sets the frequency when 10 V is input, as a percentage of the maximum frequency.   | 0.0 to 1000.0    | 100.0           | OK                       | B            | B           | B                | B           | 5-7       |
|              | Terminal 13 Gain  |  |                  |                 |                          |              |             |                  |             |           |
| H3-03        | Bias: terminal 13   | Sets the frequency when 0 V is input, as a percentage of the maximum frequency.  | -100.0 to +100.0 | 0.0             | OK                       | B            | B           | B                | B           | 5-7       |
|              | Terminal 13 Bias  |  |                  |                 |                          |              |             |                  |             |           |
| H3-04        | Multi-function analog input signal selection: terminal 16 | 0: 0 to +10 V<br>1: 0 to ±10 V   | 0, 1             | 0               | NO                       | B            | B           | B                | B           | 5-6       |
|              | Term 16 Signal  |  |                  |                 |                          |              |             |                  |             |           |
| H3-05        | Selection: Terminal 16                                    | Select from the functions listed on the following table. Refer to page 6-73.   | 0 to 1F          | 1F              | NO                       | B            | B           | B                | B           | 5-6, 6-73 |
|              | Terminal 16 Sel   |  |                  |                 |                          |              |             |                  |             |           |
| H3-06        | Gain: terminal 16   | Sets the input gain (level) when terminal 16 is 10 V. The contents in the following table are taken as 100%.                 | 0.0 to 1000.0    | 100.0           | OK                       | B            | B           | B                | B           | 5-7       |
|              | Terminal 16 Gain  |  |                  |                 |                          |              |             |                  |             |           |
| H3-07        | Bias: terminal 16   | Sets the input gain (level) when terminal 16 is 0 V. The contents in the following table are taken as 100%.                  | -100.0 to +100.0 | 0.0             | OK                       | B            | B           | B                | B           | 5-7       |
|              | Terminal 16 Bias  |  |                  |                 |                          |              |             |                  |             |           |
| H3-08        | Signal selection: terminal 14                             | 0: 0 to +10 V (Always cut jumper wire J1)<br>1: 0 to ±10 V (Always cut jumper wire J1)<br>2: 4 to 20 mA                      | 0 to 2           | 2               | NO                       | A            | A           | A                | A           | 5-5       |
|              | Term 14 Signal  |  |                  |                 |                          |              |             |                  |             |           |
| H3-09        | Selection: Terminal 14                                    | Set as for H3-05.<br>Note: Cannot be set to 0. The 1F function will become "frequency reference."                            | 1 to 1F          | 1F              | NO                       | A            | A           | A                | A           | 5-5, 6-73 |
|              | Terminal 14 Sel   |  |                  |                 |                          |              |             |                  |             |           |
| H3-10        | Gain: Terminal 14   | Sets the input gain (level) when terminal 14 is 10 V (20 mA). The contents in the following table are taken as 100%.         | 0.0 to 1000.0    | 100.0           | OK                       | A            | A           | A                | A           | 5-7       |
|              | Terminal 14 Gain  |  |                  |                 |                          |              |             |                  |             |           |
| H3-11        | Bias: Terminal 14   | Sets the input gain (level) when terminal 14 is 0 V (4 mA). The contents in the following table are taken as 100%.           | -100.0 to +100.0 | 0.0             | OK                       | A            | A           | A                | A           | 5-7       |
|              | Terminal 14 Bias  |  |                  |                 |                          |              |             |                  |             |           |
| H3-12        | Analog input filter time constant                         | Sets terminals 13, 14, 16 to primary delay filter time constant, in seconds units.<br>Note: Effective for noise control etc. | 0.00 to 2.00     | 0.00            | NO                       | A            | A           | A                | A           | 5-8       |
|              | Filter Avg Time   |  |                  |                 |                          |              |             |                  |             |           |

• Description of Multi-function Analog Input: Terminal 16

| Function |  | Contents   | Control mode |     |     |     |
|----------|--|--|--------------|-----|-----|-----|
| 0        | Auxiliary frequency reference                  | Maximum frequency  | OK           | OK  | OK  | OK  |
| 1        | Frequency gain                                 | Frequency reference command value (voltage.)             | OK           | OK  | OK  | OK  |
| 2        | Frequency bias                                 | Maximum frequency (H3-03 +)                              | OK           | OK  | OK  | OK  |
| 4        | Voltage bias                                   | Motor rated voltage (E1-05)                              | OK           | OK  | --- | --- |
| 5        | Accel/decel change                             | Set acceleration and deceleration times (C1-01 to C1-08) | OK           | OK  | OK  | OK  |
| 6        | DC injection braking current                   | Inverter rated output current                            | OK           | OK  | OK  | --- |
| 7        | Overtorque detection level                     | Motor rated torque                                       | OK           | OK  | OK  | OK  |
| 8        | Stall prevention level during run              | Inverter rated output current                            | OK           | OK  | --- | --- |
| 9        | Frequency reference lower limit level          | Maximum frequency  | OK           | OK  | OK  | OK  |
| A        | Jump frequency                                 | Maximum frequency  | OK           | OK  | OK  | OK  |
| B        | PID feedback                                   | Maximum frequency  | OK           | OK  | OK  | OK  |
| 10       | Forward side torque limit                      | Rated torque   | ---          | --- | OK  | OK  |
| 11       | Reverse side torque limit                      | Rated torque   | ---          | --- | OK  | OK  |
| 12       | Regeneration side torque limit                 | Rated torque   | ---          | --- | OK  | OK  |
| 13       | Torque reference/torque limit at speed control | Rated torque   | ---          | --- | --- | OK  |
| 14       | Torque compensation (bias)                     | Rated torque   | ---          | --- | --- | OK  |
| 15       | Forward/reverse side torque limit              | Rated torque   | ---          | --- | OK  | OK  |
| 1F       | Not used (terminal 14: frequency reference)    | ---  | OK           | OK  | OK  | OK  |

■ Analog Outputs: H4

| Constant No. | Name  | Description   | Setting range  | Default setting | Changes during operation | Control mode |             |                  |             | Page |
|--------------|---|---|----------------|-----------------|--------------------------|--------------|-------------|------------------|-------------|------|
|              | Display name  |   |                |                 |                          | V/f control  | V/f with PG | Open loop vector | Flux vector |      |
| H4-01        | Multi-function analog output 1 selection: terminal 21 | Sets the number of the monitor item to be output (U1-□□) from terminal 21.<br>Note: 4, 10, 11, 12, 13, 14, 25, 28 cannot be set and 29 to 31 are not used.  | 1 to 31        | 2               | NO                       | B            | B           | B                | B           | 6-76 |
|              | Terminal 21 Sel                                       |   |                |                 |                          |              |             |                  |             |      |
| H4-02        | Gain terminal 21                                      | Sets the multi-function analog output 1 voltage level gain.<br>Sets whether the monitor item output will be output in multiples of 10 V.  | 0.00 to 2.50   | 1.00            | OK                       | B            | B           | B                | B           | 6-76 |
|              | Terminal 21 Gain                                      |   |                |                 |                          |              |             |                  |             |      |
| H4-03        | Bias terminal 21                                      | Sets the multi-function analog output 1 voltage level bias.<br>Sets output characteristic up/down parallel movement as a percentage of 10 V.  | -10.0 to +10.0 | 0.0             | OK                       | B            | B           | B                | B           | 6-76 |
|              | Terminal 21 Bias                                      |   |                |                 |                          |              |             |                  |             |      |
| H4-04        | Multi-function analog output 2 selection: terminal 23 | Sets the number of the monitor item to be output (U1-□□) from terminal 23.<br>Note: 4, 10, 11, 12, 13, 14, 25, 28 cannot be set and 29 to 31 are not used.  | 1 to 31        | 3               | NO                       | B            | B           | B                | B           | 6-76 |
|              | Terminal 23 Sel                                       |   |                |                 |                          |              |             |                  |             |      |
| H4-05        | Gain terminal 23                                      | Sets the multi-function analog output 2 voltage level gain.<br>Sets whether the monitor item output will be output in multiples of 10 V.  | 0.00 to 2.50   | 0.50            | OK                       | B            | B           | B                | B           | 6-76 |
|              | Terminal 23 Gain                                      |   |                |                 |                          |              |             |                  |             |      |
| H4-06        | Bias terminal 23                                      | Sets the multi-function analog output 2 voltage level bias.<br>Sets output characteristic up/down parallel movement as a percentage of 10 V.  | -10.0 to +10.0 | 0.0             | OK                       | B            | B           | B                | B           | 6-76 |
|              | Terminal 23 Bias                                      |   |                |                 |                          |              |             |                  |             |      |
| H4-07        | Analog output signal level selection                  | Sets the signal output level for multi-function outputs 1 and 2 (terminals 21, 23.)<br>0: 0 to +10 V output<br>1: 0 to ±10 V output<br>Note: The optional Analog Monitor Card may also be used with this setting. | 0, 1           | 0               | NO                       | B            | B           | B                | B           | 6-77 |
|              | AO Level Select                                       |   |                |                 |                          |              |             |                  |             |      |



■ Serial Communications Setup: H5

| Constant No. | Name             | Description | Setting range | Default setting | Changes during operation | Control mode |             |                  |             | Page |
|--------------|------------------|-------------|---------------|-----------------|--------------------------|--------------|-------------|------------------|-------------|------|
|              | Display name     |             |               |                 |                          | V/f control  | V/f with PG | Open loop vector | Flux vector |      |
| H5-01        | Not used.        | Do not set. | ---           | 1F              | ---                      | ---          | ---         | ---              | ---         | ---  |
|              | Serial Comm Adr  |             |               |                 |                          |              |             |                  |             |      |
| H5-02        | Not used.        | Do not set. | ---           | 3               | ---                      | ---          | ---         | ---              | ---         | ---  |
|              | Serial Baud Rate |             |               |                 |                          |              |             |                  |             |      |
| H5-03        | Not used.        | Do not set. | ---           | 0               | ---                      | ---          | ---         | ---              | ---         | ---  |
|              | Serial Com Sel   |             |               |                 |                          |              |             |                  |             |      |
| H5-04        | Not used.        | Do not set. | ---           | 3               | ---                      | ---          | ---         | ---              | ---         | ---  |
|              | Serial Fault Sel |             |               |                 |                          |              |             |                  |             |      |
| H5-05        | Not used.        | Do not set. | ---           | 1               | ---                      | ---          | ---         | ---              | ---         | ---  |
|              | Serial Flt Dtct  |             |               |                 |                          |              |             |                  |             |      |

7-2-7 Protection Parameter Lists

■ Motor Overload: L1

| Constant No. | Name                           | Description   | Setting range | Default setting | Changes during operation | Control mode |             |                  |             | Page |
|--------------|--------------------------------|---|---------------|-----------------|--------------------------|--------------|-------------|------------------|-------------|------|
|              | Display name                   |   |               |                 |                          | V/f control  | V/f with PG | Open loop vector | Flux vector |      |
| L1-01        | Motor protection selection     | Sets whether the motor overload function is enabled or disabled at electric thermal overload relay.<br>0: Disabled<br>1: Enabled<br><br>Note: In some applications when the Inverter power supply is turned off, the thermal value is reset, so even if this parameter is set to 1, (Enabled), protection may not be effective.<br>When several motors are connected to one Inverter, set to 0 (Disabled) and ensure that each motor is installed with a protection device. | 0, 1          | 1               | NO                       | B            | B           | B                | B           | 6-77 |
|              | MOL Fault Select               |   |               |                 |                          |              |             |                  |             |      |
| L1-02        | Motor protection time constant | Sets the electric thermal detection time in seconds units.<br><br>Note: Usually setting is not necessary. The default setting is 150% overload for one minute.<br>When the motor's overload resistance is known, set at the overload resistance when the motor is hot started. (Always leave a margin for error.)   | 0.1 to 5.0    | 1.0             | NO                       | B            | B           | B                | B           | 6-78 |
|              | MOL Time Const                 |   |               |                 |                          |              |             |                  |             |      |

■ Power Loss Ridethrough: L2

| Constant No. | Name                               | Description   | Setting range            | Default setting   | Changes during operation | Control mode |             |                  |             | Page |
|--------------|------------------------------------|---|--------------------------|-------------------|--------------------------|--------------|-------------|------------------|-------------|------|
|              | Display name                       |   |                          |                   |                          | V/f control  | V/f with PG | Open loop vector | Flux vector |      |
| L2-01        | Momentary power loss selection     | 0: Disabled (Undervoltage fault detection)<br>1: Enabled (Restarted when the power returns within the time for L2-02. When L2-02 is exceeded, undervoltage fault detection.)<br>2: Enabled while CPU is operating. (Restarts when power returns during control operations. Does not detect undervoltage fault.      | 0 to 2                   | 0                 | NO                       | B            | B           | B                | B           | 6-78 |
|              | PwrL Selection                     |   |                          |                   |                          |              |             |                  |             |      |
| L2-02        | Momentary power loss ridethru      | Sets the recovery time, when momentary power loss selection (L2-01) is set to 1, in units of one second.  | 0.0 to 2.0               | 0.7 (See note 1.) | NO                       | B            | B           | B                | B           | 6-79 |
|              | PwrL Ridethru t                    |   |                          |                   |                          |              |             |                  |             |      |
| L2-03        | Minimum baseblock time (BB)        | Sets the Inverter's minimum baseblock time in units of one second, when the Inverter is restarted after power loss ridethrough.<br><br>Note: Sets the time for the motor's residual voltage to dissipate. When an overcurrent occurs when starting a speed search or DC injection braking, increase the set values. | 0.0 to 5.0               | 0.5 (See note 1.) | NO                       | B            | B           | B                | B           | 6-79 |
|              | PwrL Baseblock t                   |   |                          |                   |                          |              |             |                  |             |      |
| L2-04        | Voltage restart time               | Sets the time required to return to normal voltage at the completion of a speed search, in units of one second.<br><br>Note: Set the time required for a 200-V class Inverter to recover from 0 V to 200 VAC. (For the 400-V class Inverter, the time from 0 V to 400 VAC.)   | 0.0 to 2.0               | 0.3               | NO                       | A            | A           | A                | A           | 6-79 |
|              | PwrL V/F Ramp t                    |   |                          |                   |                          |              |             |                  |             |      |
| L2-05        | Under voltage detection level (UV) | Sets the main circuit under voltage (UV) detection level (main circuit DC voltage) in V units.<br><br>Note: Usually setting is not necessary. Insert a AC reactor and use this function to lower the main circuit under voltage detection level.  | 150 to 210 (See note 2.) | 190 (See note 2.) | NO                       | A            | A           | A                | A           | 6-80 |
|              | PUV Det Level                      |   |                          |                   |                          |              |             |                  |             |      |
| L2-06        | Not used                           | Do not set.   | ---                      | 0.0               | ---                      | ---          | ---         | ---              | ---         | ---  |
|              | KEB Frequency                      |   |                          |                   |                          |              |             |                  |             |      |

**Note 1.** The default setting depends upon the type of Inverter. The values for a 200-V class 0.4-kW Inverter will be displayed.

**Note 2.** These are values for a 200-V class Inverter. Values for the 400-V class Inverter are double.

■ Stall Prevention: L3

| Constant No. | Name                                       | Description   | Setting range | Default setting | Changes during operation | Control mode |             |                  |             | Page |
|--------------|--|---|---------------|-----------------|--------------------------|--------------|-------------|------------------|-------------|------|
|              | Display name                               |   |               |                 |                          | V/f control  | V/f with PG | Open loop vector | Flux vector |      |
| L3-01        | Stall prevention during acceleration       | 0: Disabled (Acceleration as set. With a large load, the motor may stall.)<br>1: Enabled (Acceleration stopped when L3-02 level is exceeded. Acceleration starts again when the current is returned.)   | 0 to 2        | 1               | NO                       | B            | B           | B                | X           | 6-80 |
|              | StallP Accel Sel                           | 2: Intelligent acceleration mode (Using the L3-02 level as a basis, acceleration is automatically adjusted. Set acceleration time is disregarded.)  |               |                 |                          |              |             |                  |             |      |
| L3-02        | Stall prevention level during acceleration | Effective when L3-01 is set to 1 or 2. Set as a percentage of Inverter rated output current.<br>Note: Usually setting is not necessary. The default setting reduces the set values when the motor stalls.   | 0 to 200      | 150             | NO                       | B            | B           | B                | X           | 6-80 |
|              | StallP Accel Lvl                           |   |               |                 |                          |              |             |                  |             |      |
| L3-03        | Stall prevention level during acceleration | Sets the lower limit for stall prevention during acceleration, as a percentage of the Inverter rated output current, when operation is in the frequency range above the maximum voltage frequency (E1-06.)<br>Note: Usually setting is not necessary.   | 0 to 100      | 100 (See note.) | NO                       | A            | A           | A                | X           | 6-81 |
|              | StallP CHP Lvl                             |   |               |                 |                          |              |             |                  |             |      |
| L3-04        | Stall prevention during deceleration       | 0: Disabled (Deceleration as set. If deceleration time is too short, a main circuit overvoltage may result.)<br>1: Enabled (Deceleration is stopped when the main circuit voltage exceeds the overvoltage level. Deceleration restarts when voltage is returned.)<br>2: Intelligent deceleration mode (Deceleration rate is automatically adjusted so that in Inverter can decelerate in the shortest possible time. Set deceleration time is disregarded.) | 0 to 2        | 1               | NO                       | B            | B           | B                | B           | 6-82 |
|              | StallP Decel Sel                           | Note: When a braking option (braking resistance device, Braking Resistor Unit, Braking Unit) is used, always set to 0 (Disabled.)   |               |                 |                          |              |             |                  |             |      |

| Constant No. | Name                              | Description  | Setting range | Default setting | Changes during operation | Control mode |             |                  |             | Page |
|--------------|-----------------------------------|--|---------------|-----------------|--------------------------|--------------|-------------|------------------|-------------|------|
|              | Display name                      |  |               |                 |                          | V/f control  | V/f with PG | Open loop vector | Flux vector |      |
| L3-05        | Stall prevention during run       | 0: Disabled (Runs as set. With a large load, the motor may stall.)<br>1: Enabled: Deceleration time 1 (the deceleration time for the stall prevention function is C1-02.)<br>2: Enabled: Deceleration time 2 (the deceleration time for the stall prevention function is C1-04.) | 0 to 2        | 1               | NO                       | B            | B           | X                | X           | 6-83 |
|              | StallP Run Sel                    |  |               |                 |                          |              |             |                  |             |      |
| L3-06        | Stall prevention level during run | Effective when L3-04 is 1 or 2. Set as a percentage of the Inverter rated output current.<br>Note: Usually setting is not necessary.<br>The default setting reduces the set values when the motor stalls.  | 30 to 200     | 160             | NO                       | B            | B           | X                | X           | 6-83 |
|              | StallP Run Level                  |  |               |                 |                          |              |             |                  |             |      |

**Note** When the control mode is changed, the Inverter returns to default settings. (The open loop vector control default settings will be displayed.)

■ Reference Detection: L4

| Constant No. | Name                            | Description  | Setting range    | Default setting | Changes during operation | Control mode |             |                  |             | Page |
|--------------|---------------------------------|--|------------------|-----------------|--------------------------|--------------|-------------|------------------|-------------|------|
|              | Display name                    |  |                  |                 |                          | V/f control  | V/f with PG | Open loop vector | Flux vector |      |
| L4-01        | Frequency detection level       | Effective when "Desired frequency (ref/setting) agree 1," "Frequency detection 1," "Frequency detection 2," are set for multi-function output. Frequencies to be detected are set in Hz units.                               | 0.0 to 400.0     | 0.0             | NO                       | B            | B           | B                | B           | 6-84 |
|              | Spd Agree Level                 |  |                  |                 |                          |              |             |                  |             |      |
| L4-02        | Frequency detection width       | Effective when "Frequency (ref/out) agree 1," "Desired frequency (ref/setting) agree 1," "Frequency detection 1," "Frequency detection 2" are set for multi-function output. Sets the frequency detection width in Hz units. | 0.0 to 20.0      | 2.0             | NO                       | B            | B           | B                | B           | 6-84 |
|              | Spd Agree Width                 |  |                  |                 |                          |              |             |                  |             |      |
| L4-03        | Frequency detection level (+/-) | Effective when "Desired frequency (ref/setting) agree 2," "Frequency detection 3," "Frequency detection 4," are set for multi-function output. Frequencies to be detected are set in Hz units.                               | -400.0 to +400.0 | 0.0             | NO                       | A            | A           | A                | A           | 6-84 |
|              | Spd Agree Lvl+-                 |  |                  |                 |                          |              |             |                  |             |      |
| L4-04        | Frequency detection width (+/-) | Effective when "Frequency (ref/out) agree 2," "Desired frequency (ref/setting) agree 1," "Frequency detection 3," "Frequency detection 4" are set for multi-function output. Sets the frequency detection width in Hz units. | 0.0 to 20.0      | 2.0             | NO                       | A            | A           | A                | A           | 6-84 |
|              | Spd Agree Wdth+-                |  |                  |                 |                          |              |             |                  |             |      |

| Con-stant No. | Name                                       | Description  | Setting range | Default setting | Chang-es during opera-tion | Control mode |             |                  |             | Page |
|---------------|--|--|---------------|-----------------|----------------------------|--------------|-------------|------------------|-------------|------|
|               | Display name                               |  |               |                 |                            | V/f control  | V/f with PG | Open loop vector | Flux vector |      |
| L4-05         | Operation when frequency reference is lost | 0: Stop (Operation follows the frequency reference.)<br>1: Operation at 80% speed continues. (At 80% of speed before the frequency reference was lost) | 0, 1          | 0               | NO                         | A            | A           | A                | A           | 6-85 |
|               | Ref Loss Sel                               | Note: Frequency reference is lost: Frequency reference dropped over 90% in 400 ms.   |               |                 |                            |              |             |                  |             |      |

■ Fault Restart: L5

| Con-stant No. | Name                             | Description  | Setting range | Default setting | Chang-es during opera-tion | Control mode |             |                  |             | Page |
|---------------|----------------------------------|--|---------------|-----------------|----------------------------|--------------|-------------|------------------|-------------|------|
|               | Display name                     |  |               |                 |                            | V/f control  | V/f with PG | Open loop vector | Flux vector |      |
| L5-01         | Number of auto restart attempts  | Sets the number of auto restart attempts. Automatically restarts after a fault and conducts a speed search from the run frequency.                                   | 0 to 10       | 0               | NO                         | B            | B           | B                | B           | 6-87 |
|               | Num of Restarts                  |  |               |                 |                            |              |             |                  |             |      |
| L5-02         | Auto restart operation selection | Sets whether a fault contact output is activated during fault restart.<br>0: Not output (Fault contact is not activated.)<br>1: Output (Fault contact is activated.) | 0, 1          | 0               | NO                         | B            | B           | B                | B           | 6-87 |
|               | Restart Sel                      |  |               |                 |                            |              |             |                  |             |      |

■ Torque Detection: L6

| Con-stant No. | Name                         | Description   | Setting range | Default setting | Chang-es during opera-tion | Control mode |             |                  |             | Page |
|---------------|------------------------------|---|---------------|-----------------|----------------------------|--------------|-------------|------------------|-------------|------|
|               | Display name                 |   |               |                 |                            | V/f control  | V/f with PG | Open loop vector | Flux vector |      |
| L6-01         | Torque detection selection 1 | 0: Overtorque detection disabled.<br>1: Detection during speed agree only/Operation continues after detection (Minor fault)<br>2: Detection during run/Operation continues after detection (Minor fault)<br>3: Detection during speed agree only/Inverter output is shut off after detection (Fault)<br>4: Detection during run/Inverter output is shut off after detection (Fault) | 0 to 4        | 0               | NO                         | B            | B           | B                | B           | 6-88 |
|               | Torq Det 1 Sel               |   |               |                 |                            |              |             |                  |             |      |
| L6-02         | Torque detection level1      | Vector control: Motor rated torque is set as 100%.<br>V/f control: Inverter rated output current is set as 100%.  | 0 to 300      | 150             | NO                         | B            | B           | B                | B           | 6-88 |
|               | Torq Det 1 Lvl               |   |               |                 |                            |              |             |                  |             |      |

| Constant No. | Name                         | Description  | Setting range | Default setting | Changes during operation | Control mode |             |                  |             | Page |
|--------------|------------------------------|--|---------------|-----------------|--------------------------|--------------|-------------|------------------|-------------|------|
|              | Display name                 |  |               |                 |                          | V/f control  | V/f with PG | Open loop vector | Flux vector |      |
| L6-03        | Torque detection time 1      | Sets the torque detection time in 1-second units.  | 0.0 to 10.0   | 0.1             | NO                       | B            | B           | B                | B           | 6-88 |
|              | Torq Det 1 Time              |  |               |                 |                          |              |             |                  |             |      |
| L6-04        | Torque detection selection 2 | Setting procedure is the same as for "Torque detection selection 1" (L6-01 to L6-03.)<br>The following outputs are possible:   | 0 to 4        | 0               | NO                       | A            | A           | A                | A           | 6-88 |
|              | Torq Det 2 Sel               |  |               |                 |                          |              |             |                  |             |      |
| L6-05        | Torque detection level 2     | Torque detection selection 1: Multi-function output "Torque detection selection 1" NO/NC<br>Torque detection selection 2: Multi-function output "Torque detection selection 2" NO/NC | 0 to 300      | 150             | NO                       | A            | A           | A                | A           | 6-88 |
|              | Torq Det 2 Lvl               |  |               |                 |                          |              |             |                  |             |      |
| L6-06        | Torque detection time 2      |  | 0.0 to 10.0   | 0.1             | NO                       | A            | A           | A                | A           | 6-88 |
|              | Torq Det 2 Time              |  |               |                 |                          |              |             |                  |             |      |

■ Torque Limit: L7

| Constant No. | Name                              | Description  | Setting range | Default setting | Changes during operation | Control mode |             |                  |             | Page      |
|--------------|-----------------------------------|--|---------------|-----------------|--------------------------|--------------|-------------|------------------|-------------|-----------|
|              | Display name                      |  |               |                 |                          | V/f control  | V/f with PG | Open loop vector | Flux vector |           |
| L7-01        | Forward torque limit              | Sets the torque limit value as a percentage of the motor rated torque. Four individual regions can be set. | 0 to 300      | 200             | NO                       | X            | X           | B                | B           | 6-3, 6-25 |
|              | Torq Limit Fwd                    |  |               |                 |                          |              |             |                  |             |           |
| L7-02        | Reverse torque limit              |  | 0 to 300      | 200             | NO                       | X            | X           | B                | B           | 6-3, 6-25 |
|              | Torq Limit Rev                    |  |               |                 |                          |              |             |                  |             |           |
| L7-03        | Forward regenerative torque limit |  | 0 to 300      | 200             | NO                       | X            | X           | B                | B           | 6-3, 6-25 |
|              | Torq Lmt Fwd Rgn                  |  |               |                 |                          |              |             |                  |             |           |
| L7-04        | Reverse regenerative torque limit |  | 0 to 300      | 200             | NO                       | X            | X           | B                | B           | 6-3, 6-25 |
|              | Torq Lmt Rev Rgn                  |  |               |                 |                          |              |             |                  |             |           |

■ Hardware Protection: L8

| Constant No. | Name                   | Description  | Setting range | Default setting | Changes during operation | Control mode |             |                  |             | Page |
|--------------|------------------------|--|---------------|-----------------|--------------------------|--------------|-------------|------------------|-------------|------|
|              | Display name           |  |               |                 |                          | V/f control  | V/f with PG | Open loop vector | Flux vector |      |
| L8-01        | DB resistor protection | 0: Disabled (Braking resistor is not used or the Braking Resistor Unit is used)<br>1: Enabled (Protects the braking resistor from overheating) | 0, 1          | 0               | NO                       | B            | B           | B                | B           | 6-89 |
|              | DB Resistor Prot       |  |               |                 |                          |              |             |                  |             |      |

| Constant No. | Name  | Description  | Setting range | Default setting | Changes during operation | Control mode |             |                  |             | Page |
|--------------|---|--|---------------|-----------------|--------------------------|--------------|-------------|------------------|-------------|------|
|              | Display name                                |  |               |                 |                          | V/f control  | V/f with PG | Open loop vector | Flux vector |      |
| L8-02        | Inverter overheat detection pre-alarm level | Sets the detection temperature for the Inverter overheat detection pre-alarm in °C.<br>Note: The pre-alarm detects when the cooling fin temperature reaches the set value.   | 50 to 110     | 95              | NO                       | A            | A           | A                | A           | 6-89 |
|              | OH Pre-Alarm Lvl                            |  |               |                 |                          |              |             |                  |             |      |
| L8-03        | Operation after Inverter overheat pre-alarm | Sets the operation for when the Inverter overheat pre-alarm goes ON.<br>0: Ramp to stop in deceleration time C1-02.<br>1: Coast to stop<br>2: Fast stop in fast-stop time C1-09.<br>3: Continue operation (Monitor display only.)<br>Note: A fault will be given in setting 0 to 2 and a minor fault will be given in setting 3. | 0 to 3        | 3               | NO                       | A            | A           | A                | A           | 6-89 |
|              | OH Pre-Alarm Sel                            |  |               |                 |                          |              |             |                  |             |      |
| L8-05        | Input open-phase protection selection       | 0: Disabled<br>1: Enabled (Detects if input current open-phase, power supply voltage imbalance or main circuit electrostatic capacitor deterioration occurs.)  | 0, 1          | 0               | NO                       | A            | A           | A                | A           | 6-90 |
|              | Ph Loss In Sel                              |  |               |                 |                          |              |             |                  |             |      |
| L8-07        | Output open-phase protection selection      | 0: Disabled<br>1: Enabled (Output open phase detected at less than 10% of Inverter's rated output.)<br>Note: Output open phase may be detected inadvertently when applied motor capacity is small for Inverter capacity. In this case, set to 0 (Disabled.)  | 0, 1          | 0               | NO                       | A            | A           | A                | A           | 6-90 |
|              | Ph Loss Out Sel                             |  |               |                 |                          |              |             |                  |             |      |

### 7-2-8 Operator Parameter Lists

#### ■ Monitor Select: o1

| Constant No. | Name              | Description  | Setting range | Default setting | Changes during operation | Control mode |             |                  |             | Page |
|--------------|-------------------|--|---------------|-----------------|--------------------------|--------------|-------------|------------------|-------------|------|
|              | Display name      |  |               |                 |                          | V/f control  | V/f with PG | Open loop vector | Flux vector |      |
| o1-01        | Monitor selection | Set the number of the monitor item to be displayed in the earliest 4 monitor items.<br>(U1-□□)<br>Note: The output monitor voltage (default setting) can be changed. | 4 to 28       | 6               | OK                       | B            | B           | B                | B           | 6-90 |
|              | User Monitor Sel  |  |               |                 |                          |              |             |                  |             |      |

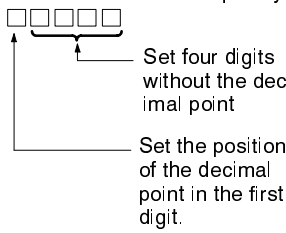
| Constant No. | Name  | Description  | Setting range | Default setting | Changes during operation | Control mode |             |                  |             | Page |
|--------------|---|--|---------------|-----------------|--------------------------|--------------|-------------|------------------|-------------|------|
|              | Display name                                  |  |               |                 |                          | V/f control  | V/f with PG | Open loop vector | Flux vector |      |
| o1-02        | Monitor selection after power-on              | Sets the monitor item to be displayed when the power is turned on.<br>1: Frequency reference<br>2: Output frequency<br>3: Output current<br>4: The monitor item set for o1-01  | 1 to 4        | 1               | OK                       | B            | B           | B                | B           | 6-90 |
|              | Power-On Monitor                              |  |               |                 |                          |              |             |                  |             |      |
| o1-03        | Frequency reference setting and display units | Sets the units that will be set and displayed for the frequency reference and frequency monitor.<br>0: 0.01-Hz units<br>1: 0.01% units (Maximum frequency is 100%)<br>2 to 39: r/min units (Sets the motor poles. Cannot be set in Vector control with PG.)<br>40 to 39999: User desired display<br>Set the desired values for setting and display for the max. frequency.<br><br><br>Example: When the max. frequency value is 200.0, set 12000 | 0 to 39999    | 0               | NO                       | B            | B           | B                | B           | 5-9  |
|              | Display Scaling                               |  |               |                 |                          |              |             |                  |             |      |
| o1-04        | V/f pattern setting units                     | Set the V/f pattern setting units. (E1-04, 06, 09 set units)<br>0: Hz units<br>1: r/min units<br>Note: Effective only in the flux control vector mode.   | 0, 1          | 0               | NO                       | X            | X           | X                | B           | 6-27 |
|              | Display Units                                 |  |               |                 |                          |              |             |                  |             |      |
| o1-05        | Not used                                      | Do not set.  | ---           | 0               | ---                      | ---          | ---         | ---              | ---         | ---  |
|              | Address Display                               |  |               |                 |                          |              |             |                  |             |      |

■ Key Selections: o2

| Constant No. | Name             | Description   | Setting range | Default setting | Changes during operation | Control mode |             |                  |             | Page |
|--------------|------------------|---|---------------|-----------------|--------------------------|--------------|-------------|------------------|-------------|------|
|              | Display name     |   |               |                 |                          | V/f control  | V/f with PG | Open loop vector | Flux vector |      |
| o2-01        | Local/Remote Key | Sets the Digital Operator Local/Remote Key enabled/disabled.<br>0: Disabled<br>1: Enabled (Switches between the Digital Operator and the parameter settings.) | 0, 1          | 1               | NO                       | B            | B           | B                | B           | 6-91 |
|              | Local/Remote Key |   |               |                 |                          |              |             |                  |             |      |



| Con-stant No. | Name  | Description   | Setting range       | Default setting | Chang-es during operation | Control mode |             |                  |             | Page |
|---------------|---|---|---------------------|-----------------|---------------------------|--------------|-------------|------------------|-------------|------|
|               | Display name  |   |                     |                 |                           | V/f control  | V/f with PG | Open loop vector | Flux vector |      |
| o2-02         | Stop Key  | Sets the Stop Key in the run mode.<br>0: Disabled (When the run command is issued from and external terminal, the Stop Key is disabled.)<br>1: Enabled (Effective even during run.)   | 0, 1                | 1               | NO                        | B            | B           | B                | B           | 6-91 |
|               | Oper Stop Key   |   |                     |                 |                           |              |             |                  |             |      |
| o2-03         | User constant initial values                              | Clears or stores user initial values.<br>0: Stores/not set<br>1: Begins storing (Records the set constants as user initial values.)<br>2: All clear (Clears all recorded user initial values)<br>Note: When the set constants are recorded as user initial values, 1110 will be displayed in the Initialize mode (A1-03.) | 0 to 2              | 0               | NO                        | B            | B           | B                | B           | 6-91 |
|               | User De-faults  |   |                     |                 |                           |              |             |                  |             |      |
| o2-04         | Inverter capacity selection                               | Do not set<br>Note: This parameter is set by the manufacturer   | 0 to FF (See note.) | 0 (See note.)   | NO                        | B            | B           | B                | B           | 6-92 |
|               | Inverter Model #  |   |                     |                 |                           |              |             |                  |             |      |
| o2-05         | Frequency reference setting method                        | When the frequency reference is set on the Digital Operator's frequency reference monitor, sets whether the Enter Key is necessary.<br>0: Enter Key needed<br>1: Enter Key not needed<br>Note: When set to 1, the Inverter accepts the frequency reference without Enter Key operation.                                   | 0, 1                | 0               | NO                        | A            | A           | A                | A           | 6-92 |
|               | Operator M.O.P.   |   |                     |                 |                           |              |             |                  |             |      |
| o2-06         | Operation selection when Digital Operator is disconnected | Sets the operation when the Digital Operator is disconnected.<br>0: Disabled (Operation continues even if the Digital Operator is disconnected.)<br>1: Enabled (OPR is detected at Digital Operator disconnection. Inverter output is cut off, and fault contact is operated.)  | 0, 1                | 0               | NO                        | A            | A           | A                | A           | 6-92 |
|               | Oper Difec-tion   |   |                     |                 |                           |              |             |                  |             |      |
| o2-07         | Cumulative operation time setting                         | Sets the cumulative operation time in hour units.<br>Note: Operation time is calculated from the set values.  | 0 to 65535          | 0               | NO                        | A            | A           | A                | A           | 6-92 |
|               | Elapsed Time Set  |   |                     |                 |                           |              |             |                  |             |      |
| o2-08         | Cumulative operation time selection                       | 0: Cumulative time when the Inverter power is on. (All time while the Inverter power is on is accumulated.)<br>1: Cumulative Inverter run time. (Only Inverter output time is accumulated.)   | 0, 1                | 0               | NO                        | A            | A           | A                | A           | 6-92 |
|               | Elapsed Time Run  |   |                     |                 |                           |              |             |                  |             |      |

| Con-stant No. | Name          | Description | Setting range | Default setting | Chan-ges during opera-tion | Control mode |             |                  |             | Page |
|---------------|---------------|-------------|---------------|-----------------|----------------------------|--------------|-------------|------------------|-------------|------|
|               | Display name  |             |               |                 |                            | V/f control  | V/f with PG | Open loop vector | Flux vector |      |
| o2-09         | Factory use   | Do not set. | ---           | 0               | ---                        | ---          | ---         | ---              | ---         | ---  |
|               | Init mode sel |             |               |                 |                            |              |             |                  |             |      |

**Note** The default setting depends upon the type of Inverter. The values for a 200-V class 0.4 kW Inverter will be displayed.

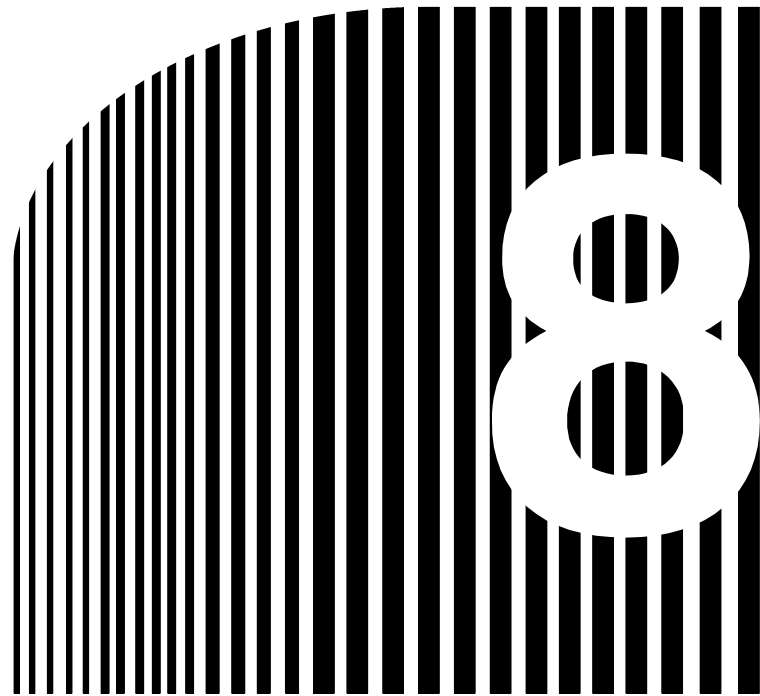

## Chapter 8

### • **Maintenance Operations**

- 8-1 Protective and Diagnostic Functions
- 8-2 Troubleshooting
- 8-3 Maintenance and Inspection

**8-1 Protective and Diagnostic Functions**

**8-1-1 Fault Detection**

When the Inverter detects a fault, the fault code is displayed on the Digital Operator, the fault contact output operates, and the Inverter output is shut OFF causing the motor to coast to a stop. (The stopping method can be selected for some faults, and the selected stopping method will be used with these faults.)

When a fault has occurred, refer to the following table to identify and correct the cause of the fault. Use one of the following methods to reset the fault after restarting the Inverter:

- Turn ON the fault reset signal.  
(A multi-function input (H1-01 to H1-06) must be set to 14 (Fault Reset).)
- Press the RESET Key on the Digital Operator.
- Turn the main circuit power supply off and then on again.

**■ Fault Displays and Processing**

| Fault Display           | Meaning  | Probable causes and remedies  |
|-------------------------|--|---|
| OC<br>Overcurrent       | The Inverter output current exceeded the overcurrent detection level.  | <ul style="list-style-type: none"> <li>• A short-circuit or ground fault occurred at the Inverter output. (A short or ground fault can be caused by motor burn damage, worn insulation, or a damaged cable.)</li> <li>• The load is too large or the acceleration/deceleration time is too short.</li> <li>• A special-purpose motor or motor with a capacity too large for the Inverter is being used.</li> <li>• A magnetic switch was switched at the Inverter's output.</li> </ul> <p>→ Reset the fault after correcting its cause.</p> |
| GF<br>Ground Fault      | The ground fault current at the Inverter's output exceeded approximately 80% of the Inverter's rated output current. | <ul style="list-style-type: none"> <li>• A ground fault occurred at the Inverter output. (A ground fault can be caused by motor burn damage, worn insulation, or a damaged cable.)</li> </ul> <p>→ Reset the fault after correcting its cause.</p>  |
| PUF<br>DC Bus Fuse Open | The fuse in the main circuit is blown.   | <ul style="list-style-type: none"> <li>• The output transistor has failed because of a short-circuit or ground fault at the Inverter output. Check whether there is a short-circuit between the following terminals. A short-circuit will damage the output transistor:<br/>B1(+3) ↔ T1(U), T2(V), T3(W)<br/>(-) ↔ T1(U), T2(V), T3(W)</li> </ul> <p>→ Replace the Inverter after correcting the cause.</p>   |

| Fault Display           | Meaning  | Probable causes and remedies   |
|-------------------------|--|--|
| SC<br>Short Circuit     | The Inverter output or load was short-circuited.   | <ul style="list-style-type: none"> <li>• A short-circuit or ground fault occurred at the Inverter output. (A short or ground fault can be caused by motor burn damage, worn insulation, or a damaged cable.)</li> <li>→ Reset the fault after correcting its cause.</li> </ul>   |
| OV<br>Overvoltage       | The main circuit DC voltage exceeded the overvoltage detection level.<br><br>200-V class: Approx. 400 V<br>400-V class: Approx. 800 V          | <ul style="list-style-type: none"> <li>• The deceleration time is too short and the regenerative energy from the motor is too large.</li> <li>→ Increase the deceleration time or connect a braking resistor (or Braking Resistor Unit).</li> <li>• A surge is generated when the phase-advancer condenser switches.</li> <li>→ Add an AC reactor to the power supply input.</li> <li>• The power supply voltage is too high.</li> <li>→ Decrease the voltage so it's within specifications.</li> </ul>  |
| UV1<br>DC Bus Undervolt | The main circuit DC voltage is below the undervoltage detection level (L2-05).<br><br>200-V class: Approx. 190 V<br>400-V class: Approx. 380 V | <ul style="list-style-type: none"> <li>• A phase loss occurred with the input power supply.</li> <li>• A momentary power interruption occurred.</li> <li>• The wiring terminals for the input power supply are loose.</li> <li>• The voltage fluctuations in the input power supply are too large.</li> <li>→ Reset the fault after correcting its cause.</li> </ul>   |
| UV2<br>CTL PS Undervolt | The control power supply voltage dropped.  | <ul style="list-style-type: none"> <li>→ Try turning the power supply off and on.</li> <li>→ Replace the Inverter if the fault continues to occur.</li> </ul>  |
| UV3<br>MC Answerback    | A failure occurred in the inrush prevention circuit.   | <ul style="list-style-type: none"> <li>→ Try turning the power supply off and on.</li> <li>→ Replace the Inverter if the fault continues to occur.</li> </ul>  |
| PF<br>Input Pha Loss    | The main circuit DC voltage oscillates unusually (not when regenerating).<br><br>This fault is detected when L8-05 is set to "Enabled."        | <ul style="list-style-type: none"> <li>• A phase loss occurred in the input power supply.</li> <li>• A momentary power interruption occurred.</li> <li>• The wiring terminals for the input power supply are loose.</li> <li>• The voltage fluctuations in the input power supply are too large.</li> <li>• The voltage balance between phases is bad.</li> <li>→ Reset the fault after correcting its cause.</li> <li>• The main circuit smoothing condenser has exceeded its life expectancy.</li> <li>→ Replace the electrolytic condenser. (Contact your OMRON representative.)</li> </ul> |

| Fault Display                   | Meaning   | Probable causes and remedies  |
|---------------------------------|---|---|
| <p>LF<br/>Output Pha Loss</p>   | <p>A phase loss occurred at the Inverter's output.<br/>This fault is detected when L8-07 is set to "Enabled."</p> | <ul style="list-style-type: none"> <li>• There is a broken wire in the output cable.</li> <li>• There is a broken wire in the motor's winding.</li> <li>• The output terminals are loose.<br/>→ Reset the fault after correcting its cause.</li> <li>• The motor being used has a capacity less than 10% of the Inverter's maximum motor capacity.<br/>→ Check the motor and Inverter capacity.</li> </ul>  |
| <p>OH<br/>Heatsink Over tmp</p> | <p>The temperature of the Inverter's cooling fins exceeded the setting in L8-02 or 105°C.</p>                     | <ul style="list-style-type: none"> <li>• The ambient temperature is too high.<br/>→ Install a cooling unit.</li> <li>• There is a heat source nearby.<br/>→ Remove the heat source.</li> <li>• The Inverter's cooling fan has stopped.<br/>→ Replace the cooling fan.<br/>(Contact your OMRON representative.)</li> <li>• High carrier frequency. (400V-class models)<br/>→ Decrease the C6-01 setting.</li> </ul>  |
| <p>RH<br/>Dyn Brk Resistor</p>  | <p>The braking resistor is overheated and the protection function set with L8-01 has operated.</p>                | <ul style="list-style-type: none"> <li>• The deceleration time is too short and the regenerative energy from the motor is too large.<br/>→ Lighten the load, increase the deceleration time, or reduce the motor speed.<br/>→ Change to a Braking Resistor Unit.</li> </ul>   |
| <p>RR<br/>Dyn Brk Transistr</p> | <p>The braking transistor is not operating properly.</p>  | <ul style="list-style-type: none"> <li>→ Try turning the power supply off and on.</li> <li>→ Replace the Inverter if the fault continues to occur.</li> </ul>   |
| <p>OL1<br/>Motor Overloaded</p> | <p>The motor overload protection function has operated based on the internal electronic thermal value.</p>        | <ul style="list-style-type: none"> <li>• The load is too large. The acceleration time, deceleration time, and cycle time are too short.<br/>→ Check the size of the load and the length of the acceleration, deceleration, and cycle times.</li> <li>• The V/f characteristics voltage is too high.<br/>→ Check the V/f characteristics.</li> <li>• The motor's rated current setting (E2-01) is incorrect.<br/>→ Check the motor's rated current setting (E2-01).</li> </ul> |

| Fault Display                   | Meaning   | Probable causes and remedies   |
|---------------------------------|---|--|
| <p>OL2<br/>Inv Overloaded</p>   | <p>The Inverter overload protection function has operated based on the internal electronic thermal value.</p> | <ul style="list-style-type: none"> <li>• The load is too large. The acceleration time, deceleration time and cycle time are too short.                             <ul style="list-style-type: none"> <li>→ Check the size of the load and the length of the acceleration, deceleration, and cycle times.</li> </ul> </li> <li>• The V/f characteristics voltage is too high.                             <ul style="list-style-type: none"> <li>→ Check the V/f characteristics.</li> </ul> </li> <li>• The Inverter's capacity is too low.                             <ul style="list-style-type: none"> <li>→ Replace the Inverter with one that has a larger capacity.</li> </ul> </li> <li>• High carrier frequency.                             <ul style="list-style-type: none"> <li>→ Decrease the C6-01 setting.</li> </ul> </li> </ul> |
| <p>OL3<br/>Overtorque Det 1</p> | <p>There has been a current greater than the setting in L6-02 for longer than the setting in L6-03.</p>       | <ul style="list-style-type: none"> <li>→ Make sure that the settings in L6-02 and L6-03 are appropriate.</li> <li>→ Check the mechanical system and correct the cause of the overtorque.</li> </ul>  |
| <p>OL4<br/>Overtorque Det 2</p> | <p>There has been a current greater than the setting in L6-05 for longer than the setting in L6-06.</p>       | <ul style="list-style-type: none"> <li>→ Make sure that the current setting in L6-05 and time setting in L6-06 are appropriate.</li> <li>→ Check the mechanical system and correct the cause of the overtorque.</li> </ul>   |
| <p>OS<br/>Over speed</p>        | <p>The speed has been greater than the setting in F1-08 for longer than the setting in F1-09.</p>             | <ul style="list-style-type: none"> <li>• Overshooting/Undershooting are occurring.                             <ul style="list-style-type: none"> <li>→ Adjust the gain again.</li> </ul> </li> <li>• The reference speed is too high.                             <ul style="list-style-type: none"> <li>→ Check the reference circuit and reference gain.</li> </ul> </li> <li>• The settings in F1-08 and F1-09 aren't appropriate.                             <ul style="list-style-type: none"> <li>→ Check the settings in F1-08 and F1-09.</li> </ul> </li> </ul>  |
| <p>PGO<br/>PG open</p>          | <p>The PG is disconnected. The Inverter is outputting a frequency, but PG pulses aren't being input.</p>      | <ul style="list-style-type: none"> <li>• There is a break in the PG wiring.                             <ul style="list-style-type: none"> <li>→ Fix the broken/disconnected wiring.</li> </ul> </li> <li>• The PG is wired incorrectly.                             <ul style="list-style-type: none"> <li>→ Fix the wiring.</li> </ul> </li> <li>• Power isn't being supplied to the PG.                             <ul style="list-style-type: none"> <li>→ Supply power to the PG properly.</li> </ul> </li> </ul>  |
| <p>DEV<br/>Speed Deviation</p>  | <p>The speed deviation has been greater than the setting in F1-10 for longer than the setting in F1-11.</p>   | <ul style="list-style-type: none"> <li>• The load is too large.                             <ul style="list-style-type: none"> <li>→ Lighten the load.</li> </ul> </li> <li>• The acceleration time and deceleration time are too short.                             <ul style="list-style-type: none"> <li>→ Lengthen the acceleration time and deceleration time.</li> </ul> </li> <li>• The load is locked.                             <ul style="list-style-type: none"> <li>→ Check the mechanical system.</li> </ul> </li> <li>• The settings in F1-10 and F1-11 aren't appropriate.                             <ul style="list-style-type: none"> <li>→ Check the settings in F1-10 and F1-11.</li> </ul> </li> </ul>   |

| Fault Display             | Meaning  | Probable causes and remedies  |
|---------------------------|--|---|
| EF3<br>External Fault 3   | External fault (Input terminal 3)  | <ul style="list-style-type: none"> <li>• An “external fault” was input from a multi-function input.</li> <li>→ Reset external fault inputs to the multi-function inputs.</li> <li>→ Remove the cause of the external fault.</li> </ul>  |
| EF4                       | External fault (Input terminal 4)  |   |
| EF5                       | External fault (Input terminal 5)  |   |
| EF6                       | External fault (Input terminal 6)  |   |
| EF7                       | External fault (Input terminal 7)  |   |
| EF8                       | External fault (Input terminal 8)  |   |
| CPF00<br>COM-ERR (OP&INV) | Communications with the Operator were not established within 5 seconds after the power was turned on.                    | <ul style="list-style-type: none"> <li>• The Digital Operator’s connector isn’t connected properly.</li> <li>→ Disconnect the Digital Operator and then connect it again.</li> <li>• The Inverter CPU’s peripheral element is faulty.</li> <li>→ Replace the Inverter.</li> </ul> |
| CPF01<br>COM-ERR (OP&INV) | After communications were established, there was a transmission error with the Digital Operator for more than 2 seconds. | <ul style="list-style-type: none"> <li>• The Digital Operator isn’t connected properly.</li> <li>→ Disconnect the Digital Operator and then connect it again.</li> <li>• The Inverter CPU’s peripheral element is faulty.</li> <li>→ Replace the Inverter.</li> </ul>             |
| CPF02<br>BB Circuit Err   | Baseblock circuit error  | <ul style="list-style-type: none"> <li>→ Try turning the power supply off and on again.</li> <li>• The control circuit is damaged.</li> <li>→ Replace the Inverter.</li> </ul>  |
| CPF03<br>EEPROM Error     | EEPROM error   | <ul style="list-style-type: none"> <li>→ Try turning the power supply off and on again.</li> <li>• The control circuit is damaged.</li> <li>→ Replace the Inverter.</li> </ul>  |
| CPF04<br>Internal A/D Err | CPU internal A/D converter error   | <ul style="list-style-type: none"> <li>→ Try turning the power supply off and on again.</li> <li>• The control circuit is damaged.</li> <li>→ Replace the Inverter.</li> </ul>  |
| CPF05<br>External A/D Err | CPU external A/D converter error   | <ul style="list-style-type: none"> <li>→ Try turning the power supply off and on again.</li> <li>• The control circuit is damaged.</li> <li>→ Replace the Inverter.</li> </ul>  |
| CPF06<br>Option Error     | Optional Card connection error   | <ul style="list-style-type: none"> <li>• The Optional Card isn’t connected properly.</li> <li>→ Turn off the power and insert the Card again.</li> <li>• The Inverter or Optional Card is faulty.</li> <li>→ Replace the faulty component.</li> </ul>                             |
| CPF20<br>Option A/D Error | Optional Card A/D converter error  | <ul style="list-style-type: none"> <li>• The Optional Card isn’t connected properly.</li> <li>→ Turn off the power and insert the Card again.</li> <li>• The Optional Card’s A/D converter is faulty.</li> <li>→ Replace the Optional Card.</li> </ul>                            |



## 8-1-2 Minor Fault Detection

Minor faults are a type of Inverter protection function that do not operate the fault contact output and are automatically returned to their original status once the cause of the minor fault has been removed. The Digital Operator display flashes and the minor fault is output from the multi-function outputs (H2-01 to H2-03). Take appropriate countermeasures according to the table below.

### ■ Minor Fault Displays and Processing

| Minor fault display                | Meaning  | Probable causes and remedies   |
|------------------------------------|--|--|
| EF (flashing)<br>External Fault    | Both the forward and reverse commands have been ON for more than 0.5 s.  | <ul style="list-style-type: none"> <li>→ Check the sequence of the forward and reverse commands.</li> <li>* Since the rotational direction is unknown, the motor will be decelerated to a stop when this minor fault occurs.</li> </ul>  |
| UV (flashing)<br>DC Bus Undervolt  | The main circuit DC voltage is below the undervoltage detection level (L2-05).<br>200-V class: Approx. 190 V<br>400-V class: Approx. 380 V | <ul style="list-style-type: none"> <li>• A phase loss occurred with the input power supply.</li> <li>• A momentary power interruption occurred.</li> <li>• The wiring terminals for the input power supply are loose.</li> <li>• The voltage fluctuations in the input power supply are too large.</li> </ul> <p>→ Reset the fault after correcting its cause.</p>   |
| OV (flashing)<br>Overvoltage       | The main circuit DC voltage exceeded the overvoltage detection level.<br>200-V class: Approx. 400 V<br>400-V class: Approx. 800 V          | <ul style="list-style-type: none"> <li>• The power supply voltage is too high.</li> </ul> <p>→ Decrease the voltage so it's within specifications.</p>   |
| OH (flashing)<br>Heatsink Over tmp | The temperature of the Inverter's cooling fins exceeded the setting in L8-02.  | <ul style="list-style-type: none"> <li>• The ambient temperature is too high. <ul style="list-style-type: none"> <li>→ Install a cooling unit.</li> </ul> </li> <li>• There is a heat source nearby. <ul style="list-style-type: none"> <li>→ Remove the heat source.</li> </ul> </li> <li>• The Inverter's cooling fan has stopped. <ul style="list-style-type: none"> <li>→ Replace the cooling fan.<br/>(Contact your OMRON representative.)</li> </ul> </li> <li>• High carrier frequency. (400V-class models) <ul style="list-style-type: none"> <li>→ Decrease the C6-01 setting.</li> </ul> </li> </ul> |
| OH2 (flashing)<br>Over Heat 2      | An OH2 alarm signal (Inverter overheating alarm signal) was input from a multi-function input.   | <ul style="list-style-type: none"> <li>• Clear the multi-function input's overheating alarm input.</li> </ul>  |
| OL3 (flashing)<br>Overtorque Det 1 | There has been a current greater than the setting in L6-02 for longer than the setting in L6-03.   | <ul style="list-style-type: none"> <li>→ Make sure that the settings in L6-02 and L6-03 are appropriate.</li> <li>→ Check the mechanical system and correct the cause of the overtorque.</li> </ul>  |

| Minor fault display                | Meaning  | Probable causes and remedies   |
|------------------------------------|--|--|
| OL4 (flashing)<br>Overtorque Det 2 | There has been a current greater than the setting in L6-05 for longer than the setting in L6-06.     | <ul style="list-style-type: none"> <li>→ Make sure that the current setting in L6-05 and time setting in L6-06 are appropriate.</li> <li>→ Check the mechanical system and correct the cause of the overtorque.</li> </ul>   |
| OS (flashing)<br>Over speed        | The speed has been greater than the setting in F1-08 for longer than the setting in F1-09.           | <ul style="list-style-type: none"> <li>• Overshooting/undershooting are occurring.                             <ul style="list-style-type: none"> <li>→ Adjust the gain again.</li> </ul> </li> <li>• The reference speed is too high.                             <ul style="list-style-type: none"> <li>→ Check the reference circuit and reference gain.</li> </ul> </li> <li>• The settings in F1-08 and F1-09 aren't appropriate.                             <ul style="list-style-type: none"> <li>→ Check the settings in F1-08 and F1-09.</li> </ul> </li> </ul>  |
| PGO (flashing)<br>PG open          | The PG is disconnected. The Inverter is outputting a frequency, but PG pulses aren't being input.    | <ul style="list-style-type: none"> <li>• There is a break in the PG wiring.                             <ul style="list-style-type: none"> <li>→ Fix the broken/disconnected wiring.</li> </ul> </li> <li>• The PG is wired incorrectly.                             <ul style="list-style-type: none"> <li>→ Fix the wiring.</li> </ul> </li> <li>• Power isn't being supplied to the PG.                             <ul style="list-style-type: none"> <li>→ Supply power to the PG properly.</li> </ul> </li> </ul>  |
| DEV (flashing)<br>Speed Deviation  | The speed deviation has been greater than the setting in F1-10 for longer than the setting in F1-11. | <ul style="list-style-type: none"> <li>• The load is too large.                             <ul style="list-style-type: none"> <li>→ Lighten the load.</li> </ul> </li> <li>• The acceleration time and deceleration time are too short.                             <ul style="list-style-type: none"> <li>→ Lengthen the acceleration time and deceleration time.</li> </ul> </li> <li>• The load is locked.                             <ul style="list-style-type: none"> <li>→ Check the mechanical system.</li> </ul> </li> <li>• The settings in F1-10 and F1-11 aren't appropriate.                             <ul style="list-style-type: none"> <li>→ Check the settings in F1-10 and F1-11.</li> </ul> </li> </ul> |
| EF3 (flashing)<br>External Fault 3 | External fault (Input terminal 3)  | <ul style="list-style-type: none"> <li>• An "external fault" was input from a multi-function input.                             <ul style="list-style-type: none"> <li>→ Reset external fault inputs to the multi-function inputs.</li> <li>→ Remove the cause of the external fault.</li> </ul> </li> </ul>   |
| EF4 (flashing)                     | External fault (Input terminal 4)  |  |
| EF5 (flashing)                     | External fault (Input terminal 5)  |  |
| EF6 (flashing)                     | External fault (Input terminal 6)  |  |
| EF7 (flashing)                     | External fault (Input terminal 7)  |  |
| EF8 (flashing)                     | External fault (Input terminal 8)  |  |
| ERR (flashing)<br>EEPROM R/W Err   | A verification error occurred when writing EEPROM.   | <ul style="list-style-type: none"> <li>→ Try turning the power supply off and on again.</li> <li>→ Try setting the parameters again.</li> </ul>  |

### 8-1-3 Operation Errors

After the parameters have been set, an operation error will occur if there is an invalid setting or a contradiction between two parameter settings.

It won't be possible to start the Inverter until the parameters have been set correctly.

(The minor fault output and fault contact output will not operate, either.)

When an operation error has occurred, refer to the following table to identify and correct the cause of the errors.

#### ■ Operation Error Displays and Incorrect Settings

| Display                   | Meaning                                     | Incorrect settings  |
|---------------------------|---|---|
| OPE01<br>kVA Selection    | Incorrect Inverter capacity setting         | <ul style="list-style-type: none"> <li>The Inverter capacity setting doesn't match the Unit. (Contact your OMRON representative.)</li> </ul>  |
| OPE02<br>Limit            | Parameter setting range error               | <ul style="list-style-type: none"> <li>The parameter setting is outside of the valid setting range.</li> </ul>  |
| OPE03<br>Terminal         | Multi-function input selection error        | <ul style="list-style-type: none"> <li>One of the following errors has been made in the multi-function input (H1-01 to H1-06) settings:               <ul style="list-style-type: none"> <li>The same setting has been selected for two or more multi-function inputs.</li> <li>An UP or DOWN command was selected independently. (They must be used together.)</li> <li>The UP/DOWN commands (10 and 11) and Accel/Decel Ramp Hold (A) were selected at the same time.</li> <li>Speed Search 1 (61) and Speed Search 2 (62) were selected at the same time.</li> <li>External Baseblock N.O. (8) and External Baseblock N.C. (9) were selected at the same time.</li> <li>The UP/DOWN commands (10 and 11) were selected while PID control (b5-01) was enabled.</li> <li>The Terminal 13/14 Switch (1F) was selected, but the terminal 14 function selector (H3-09) wasn't set to frequency reference (1F).</li> </ul> </li> </ul> |
| OPE05<br>Sequence Select  | Optional Card selection error               | <ul style="list-style-type: none"> <li>The Optional Card was selected as the frequency reference source by setting b1-01 to 3, but an Optional Card isn't connected.</li> </ul>   |
| OPE06<br>PG Opt Missing   | Control mode selection error                | <ul style="list-style-type: none"> <li>V/f control with PG feedback was selected by setting A1-02 to 1, but a PG Speed Control Card isn't connected.</li> <li>Flux vector control was selected by setting A1-02 to 3, but a PG Speed Control Card isn't connected.</li> </ul>   |
| OPE07<br>Analog Selection | Multi-function analog input selection error | <ul style="list-style-type: none"> <li>The same setting (other than 1F) has been selected for H3-05 and H3-09.</li> <li>A 3G3IV-PA114B Analog Reference Card is being used and F2-01 is set to 0, but a multi-function input (H1-01 to H1-06) has been set to Option/Inverter Selection (2).</li> </ul>   |

| Display                        | Meaning                 | Incorrect settings   |
|--------------------------------|-------------------------|--|
| OPE10<br>V/f Ptrn Setting      | V/f data setting error  | <ul style="list-style-type: none"> <li>• Parameters E1-04, E1-06, E1-07, and E1-09 do not satisfy the following conditions:</li> <li>• E1-04 (<math>F_{MAX}</math>) <math>\geq</math> E1-06 (<math>F_A</math>) <math>&gt;</math> E1-07 (<math>F_B</math>) <math>\geq</math> E1-09 (<math>F_{MIN}</math>)</li> </ul>  |
| OPE11<br>CarrFrg /<br>On-Delay | Parameter setting error | <ul style="list-style-type: none"> <li>• One of the following parameter setting errors exists.</li> <li>• The carrier frequency upper limit (C6-01) <math>&gt;</math> 5 KHz and the carrier frequency lower limit (C6-02) <math>\leq</math> 5 KHz.</li> <li>• The carrier frequency gain (C6-03) <math>&gt;</math> 6 and (C6-01) <math>&lt;</math> (C6-02).</li> </ul> |

---

## 8-2 Troubleshooting

---

---

---

Due to parameter setting errors, faulty wiring, and so on, the Inverter and motor may not operate as expected when the system is started up. If that should occur, use this section as a reference and apply the appropriate measures. If the contents of the fault are displayed, refer to *8-1 Protective and Diagnostic Functions*.

---

---

### ■ If Parameter Constants Cannot Be Set.

- **The display does not change when the Increment and Decrement Keys are pressed.**

- **Passwords do not match.**

If the parameter A1-04 (Password 1) and A1-05 (Password 2) numbers are different, the constants for the initialize mode cannot be changed. Reset the password. If you cannot remember the password, display A1-05 (select password) by pressing the Reset/Select Key and the Menu Key simultaneously while in the A1-04 display. Then reset the password. (Input the reset password in parameter A1-04.)

- **Constant write-in prohibition is input.**

This occurs when “program lockout” (set value: 1B) is set for a multi-function input. If the program lock-out input is OFF, the constants cannot be changed. Turn it ON and then set the constants.

- **The Inverter is operating (drive mode).**

There are some constants that cannot be set during operation. Turn the Inverter off and then make the settings.

- **OPE01 through OPE11 is displayed.**

This is a parameter setting error. The set value for the parameter constant is wrong. Refer to *8-1-3 Operation Errors* and correct the setting.

- **CPF00 or CPF01 is displayed.**

This is a Digital Operator transmission fault. The connection between the Digital Operator and the Inverter may be faulty. Remove the Digital Operator and then re-install it.

### ■ If the Motor Does Not Operate

- **The motor does not operate when the Run Key on the Digital Operator is pressed.**

- **The operation method setting is wrong.**

If parameter b1-02 (run source) is set to “1” (control circuit terminal), the motor will not operate when the Run Key is pressed. Either press the Local/Remote Key\* to switch to Digital Operator operation or set parameter b1-02 to “0” (Digital Operator).

\* The Local/Remote Key is enabled (set value: 1) or disabled (set value: 2) by means of parameter o2-01. It is enabled when the drive mode is entered.

- **The Inverter is not in operation mode.**

If the Inverter is not in drive mode, it will remain in ready status and will not start. Press the Menu Key to display the operation mode, and enter the drive mode by pressing the Enter Key.

- **The frequency reference is too low.**

If the frequency reference is set below the frequency set in E1-09 (minimum output frequency), the Inverter will not operate. Raise the frequency reference to at least the minimum output frequency.

- **There is a multi-function analog input setting error.**

If multi-function analog inputs H3-05 and H3-09 are set to "1" (frequency gain), and if no voltage (current) is input, then the frequency reference will be zero. Check to be sure that the set value and analog input value are correct.

- **Frequency reference 2 is specified with multi-step speed operation, and auxiliary frequency reference is not input.**

If multi-function analog input H3-05 is set to "0" (auxiliary frequency reference), and if multi-step speed reference is used, the auxiliary frequency reference will be treated as frequency reference 2. Check to be sure that the set value and analog input value (terminal 16) are correct.

- **The motor does not operate when an external operation signal is input.**

- **The operation method selection is wrong.**

If parameter b1-02 (run source) is set to "0" (Digital Operator), the motor will not operate when an external operation signal is input. Set b1-02 to "1" (control circuit terminal) and try again. Similarly, the motor will also not operate if the Local/Remote Key has been pressed to switch to Digital Operator operation. In that case press the Local/Remote Key\* again to return to the original setting.

\* The Local/Remote Key is enabled (set value: 1) or disabled (set value: 2) by means of parameter o2-01. It is enabled when drive mode is entered.

- **A 3-wire sequence is in effect.**

The input method for a 3-wire sequence is different than when operating by forward/stop and reverse/stop (2-wire sequence). When 3-wire sequence is set, the motor will not operate even when an input terminal suitable for forward/stop and reverse/stop is turned ON. When using a 3-wire sequence, refer to the timing chart on page 5-15 and input the proper signals. When using a 2-wire sequence, set multi-function inputs H1-01 through H1-06 to a value other than 0.

- **The Inverter is not in operation mode.**

If the Inverter is not in operation mode, it will remain in ready status and will not start. Press the Menu Key to display the drive mode, and enter the drive mode by pressing the Enter Key.

- **The frequency reference is too low.**

If the frequency reference is set below the frequency set in E1-09 (minimum output frequency), the Inverter will not operate. Raise the frequency reference to at least the minimum output frequency.

- **There is a multi-function analog input setting error.**

If multi-function analog inputs H3-05 and H3-09 are set to "1" (frequency gain), and if no voltage (current) is input, then the frequency reference will be zero. Check to be sure that the set value and analog input value are correct.

- **Frequency reference 2 is specified with multi-step speed operation and auxiliary frequency reference is not input.**

If multi-function analog input H3-05 is set to "0" (auxiliary frequency reference) and if multi-step speed reference is used, the auxiliary frequency reference will be treated as frequency reference 2. Check to be sure that the set value and analog input value (terminal 16) are correct.

- **The motor stops during acceleration or when a load is connected.**

The load may be too big. The 3G3FV has a stall prevention function and an automatic torque boost function, but the motor responsiveness limit may be exceeded if acceleration is too rapid or if the load is too big. Lengthen the acceleration time or reduce the load. Also consider increasing the motor capacity.

- **The motor only rotates in one direction.**

“Reverse run prohibited” is selected. If b1-04 (prohibition of reverse operation) is set to “1” (reverse run prohibited), the Inverter will not receive reverse run commands. To use both forward and reverse operation, set b1-04 to “0.”

- **If the Direction of the Motor’s Rotation is Reversed**

The motor’s output wiring is faulty. When the Inverter’s T1(U), T2(V), and T3(W) are properly connected to the motor’s T1(U), T2(V), and T3(W), the motor operates in a forward direction when a forward command is executed. The forward direction depends on the maker and the motor type, so be sure to check the specifications. Switching two wires among the T1(U), T2(V), and T3(W) will reverse the direction of rotation.

- **If the Motor Does Not Put Out Torque or If Acceleration is Slow**

- **The torque limit has been reached.**

When a torque limit has been set in parameters L7-01 to L7-04, no torque will be output beyond that limit. This can cause the torque to be insufficient, or the acceleration time to be too long. Check to be sure that the value set for the torque limit is suitable. If the torque limit has been set by multi-function analog inputs H3-05 and H3-09 (set value: 10 to 13), check to be sure that the analog input value is suitable.

- **The stall prevention level during acceleration is too low.**

If the value set for L3-02 (stall prevention level during acceleration) is too low, the acceleration time will be too long. Check to be sure that the set value is suitable.

- **The stall prevention level during running is too low.**

If the value set for L3-06 (stall prevention level during running) is too low, the speed will drop before outputting torque. Check to be sure that the set value is suitable.

- **If the Motor Does Not Operate According to Reference**

- **The motor runs faster than reference.**

- **The frequency reference bias setting is wrong.**

The frequency reference bias set in parameter H3-03 is added to the frequency reference. Check to be sure that the set value is suitable.

- **Frequency bias is set for multi-function analog inputs.**

When “2” (frequency bias) is set for multi-function analog inputs H3-05 and H3-09, a frequency corresponding to the input voltage (current) is added to the frequency reference. Check to be sure that the set value and analog input value are suitable.

- **A signal is being input to the frequency reference (current) terminal 14.**

When “1F” (frequency reference) is set for parameter H3-09 (multi-function analog input terminal 14), a frequency corresponding to the terminal 14 input input voltage (current) is added to the frequency reference. Check to be sure that the set value and analog input value are suitable.

- **The motor does not rotate according to reference.**

Torque control mode is selected. When parameter d5-01 (torque control selection) is set to “1” (torque control), speed control cannot be executed. (Speed limits can be set.) To switch torque control and speed control, set parameter d5-01 to “0” (speed control) and set one of the parameters from H1-01 through H1-06 (multi-function inputs) to “71” (speed/torque control change).

- **If the Slip Compensation Function Has Low Speed Precision**

The slip compensation limit has been reached. With the slip compensation function, compensation cannot be carried out beyond the slip compensation limit set in parameter C3-03. Check to be sure that the set value is suitable.

- **If There is Low Speed Precision at High-speed Rotation in Open-loop Control Mode**

The motor’s rated voltage is high. The Inverter’s maximum output voltage is determined by its input voltage. (For example, if 200 VAC is input, then the maximum output voltage will be 200 VAC.) If, as a result of vector control, the output voltage reference value exceeds the Inverter output voltage maximum value, the speed precision will decrease. Either use a motor with a low rated voltage (i.e., a special motor for use with vector control) or change to flux vector control.

- **If Motor Deceleration is Slow**

- **The deceleration time is long even when control resistance is connected.**

- “Stall prevention during deceleration enabled” is set. When control resistance is connected, set parameter L3-04 (stall prevention selection during deceleration) to “0” (disabled). When this parameter is set to “1” (enabled, the factory-set default), control resistance is not used.

- **The deceleration time setting is too long.**

Check the deceleration time setting (parameters C1-02, C1-04, C1-06, and C1-08).

- **Motor torque is insufficient.**

If the parameter constants are correct and there is no overvoltage fault, then the motor’s power is limited. Consider increasing the motor capacity.

- **The torque limit has been reached.**

When a torque limit has been set in parameters L7-01 to L7-04, no torque will be output beyond that limit. This can cause the deceleration time to be too long. Check to be sure that the value set for the torque limit is suitable. If the torque limit has been set by multi-function analog inputs H3-05 and H3-09 (set value: 10 to 13), check to be sure that the analog input value is suitable.



### ■ If the Vertical-axis Load Drops When Brake is Applied

- **The sequence is incorrect.**

The Inverter goes into DC braking status for 0.5 seconds after deceleration is completed. (This is the factory-set default.) Either check the sequence to make sure that the brake is applied with DC braking status, or adjust parameter b2-04 (DC injection braking time at stop).

- **The DC braking is insufficient.**

If the DC braking power is insufficient, adjust parameter b2-02 (DC injection braking current).

- **An inappropriate brake is being used.**

Use a brake intended for braking rather than holding.

### ■ If the Motor Burns Out

- **The load is too big.**

If the motor's load is too big and the motor is used with the effective torque exceeding the motor's rated torque, the motor will burn out. Also, if the motor's inscription states that the motor is rated for eight hours, for example, the motor's rated torque and capacity may be limited to eight hours of use. If that 8-hour rated torque is used for normal operation it may cause the motor to burn out. Reduce the load amount by either lightening the load or lengthening the acceleration/deceleration time. Also consider increasing the motor capacity.

- **The ambient temperature is too high.**

The motor's rating is determined within a particular ambient operating temperature range. The motor will burn out if it is run continuously at the rated torque in an environment in which the maximum ambient operating temperature is exceeded. Lower the motor's ambient temperature to within the acceptable ambient operating temperature range.

- **The withstand voltage between the motor's phases is insufficient.**

When the motor is connected to the Inverter's output, a surge is generated between the Inverter's switching and the motor's coil. Normally the maximum surge voltage is three times the Inverter's input power supply voltage (i.e., 600 V for 200-V class, and 1,200 V for 400-V class). Be sure to use a motor with a withstand voltage between the motor's phases that is greater than the maximum surge voltage. In particular, when using a 400-V-class Inverter, use a special motor for Inverters.

### ■ If There is Noise When the Inverter is Started or From an AM Radio

If noise is generated by Inverter switching, implement the following countermeasures:

- Lower the Inverter's carrier frequency (parameter C6-01). This will help to some extent by reducing the amount of internal switching.
- Install a 3G3IV-PHF Input Noise Filter at the Inverter's power supply input area.
- Install a 3G3IV-PLF Output Noise Filter at the Inverter's power supply output area.
- Use metal tubing. Electric waves can be shielded by metal, so encase the Inverter with metal (steel).

### ■ If the Leakage Breaker Operates When the Inverter is Run

The Inverter performs internal switching, so there is a certain amount of leakage current. This may cause the leakage breaker to operate and cut off the power supply. Change to a leakage breaker with a high leakage detection level (i.e., a sensitivity current of 200 mA or greater per Unit, with an operating time of 0.1 s or more), or one that incorporates high frequency countermeasures (i.e., one designed for use with Inverters).

It will also help to some extent to lower the Inverter's carrier frequency (parameter C6-01). In addition, remember that the leakage current increases as the cable is lengthened. (In general, approximately 5 mA of leakage current occurs for each meter of cable.)

## ■ If There is Mechanical Vibration

### ● The machinery is making unusual sounds.

- There may be resonance between the mechanical system's characteristic frequency and the carrier frequency. If the motor is running with no problems and the machinery is vibrating with a high-pitched whine, it may indicate that this is occurring. To prevent this type of resonance, adjust the carrier frequency with parameters C6-01 to C6-03.
- There may be resonance between a machine's characteristic frequency and the output frequency of the Inverter. To prevent this from occurring, either use the jump frequency functions in parameters d3-01 to d3-04 or install rubber padding on the motor base to reduce vibration.

### ● Vibration and hunting are occurring with open-loop vector control.

The gain adjustment may be insufficient. Reset the gain to a more effective level by adjusting parameters C4-02 (torque compensation time constant), C8-08 (AFR gain), and C3-02 (slip compensation primary delay time) in order. Lower the gain setting and raise the primary delay time setting.

### ● Vibration and hunting are occurring with V/f control.

The gain adjustment may be insufficient. Reset the gain to a more effective level by adjusting parameters C4-02 (torque compensation time constant), C7-02 (hunting prevention gain), and C3-02 (slip compensation primary delay time) in order. Lower the gain setting and raise the primary delay time setting.

### ● Vibration and hunting are occurring with flux vector control.

The gain adjustment may be insufficient. Adjust the various types of speed control loop (ASR) gain. (For details, refer to *Chapter 5 Basic Operation* of this manual.) If the mechanical system's resonance point coincides with the Inverter's operating frequency and the vibration cannot be eliminated in this way, increase the ASR primary delay time (parameter C5-06) and then try adjusting the gain again.

### ● Vibration and hunting are occurring with V/f w/PG control.

The gain adjustment may be insufficient. Adjust the various types of speed control loop (ASR) gain. (For details, refer to *Chapter 5 Basic Operation* of this manual.) If the vibration cannot be eliminated in this way, set the hunting prevention selection (parameter C7-01) to "0" (disabled) and then try adjusting the gain again.

### ● Vibration and hunting are occurring with PID control.

Check the vibration cycle and individually adjust the P, I, and D. (Refer to page 6-44.)

## ■ If the Motor Rotates Even When Inverter Output is Stopped

The DC braking is not operating properly. If the motor continues operating at low speed, without completely stopping, and after a deceleration stop has been executed, it means that the DC braking is not decelerating enough. Adjust the DC braking as follows:

- Increase the parameter b2-02 (DC injection braking current) setting.
- Increase the parameter b2-04 (DC injection braking time at stop) setting.

### ■ If 0 V is Detected When the Fan is Started, or Fan Stalls

DC braking is insufficient at startup. Generation of 0 V and stalling can occur if the fan is turning when it is started. This can be prevented by slowing fan rotation by DC braking before starting the fan. Increase the parameter b2-03 (DC injection braking time at start) setting.

### ■ If Output Frequency Does Not Rise to Frequency Reference

#### • The frequency reference is within the jump frequency range.

When the jump frequency function is used, the output frequency does not change within the jump frequency range. Check to be sure that the jump frequency (parameters d3-01 to d3-03) and jump frequency width (parameter d3-04) settings are suitable.

#### • The frequency reference upper limit has been reached.

The output frequency upper limit is determined by the following formula:

$$\text{Maximum output frequency (E1-04)} \times \text{Frequency reference upper limit (d2-01)} / 100$$

Check to be sure that the parameter E1-04 and d2-01 settings are suitable.

### ■ Inverter Overload “OL2” is Detected







For a 400-V Inverter, if the carrier frequency “C6-01” is set to a value higher than the default setting, the Inverter overload “OL2” detection value will decrease in consideration of an increase in the heat that will be generated by the change in the carrier frequency. Since the detection value is set to decrease by approximately 15% for every increase of 2 kHz from the default setting, the Inverter overload “OL2” may be detected prior to the motor overload “OL1” depending on the set value. Set the carrier frequency to a lower level.

---

## 8-3 Maintenance and Inspection

---

### ■ Cautions and Warnings

-  **WARNING** Do not touch terminals while the power is turned on. Doing so can result in electric shock.
-  **WARNING** Before performing maintenance or inspection, be sure to first turn off the power supply. Check the LED indicators on the front panel to confirm that the power supply has been turned off, and then wait for the specified period of time before beginning. Failure to do this can result in electric shock.
-  **WARNING** Maintenance, inspection, and replacement of parts must always be performed only by authorized personnel. Attempts by unauthorized persons to perform these operations can result in serious injury.
-  **WARNING** Absolutely do not disassemble the equipment. Doing so can result in serious injury to personnel and damage to the equipment.
-  **Caution** Inverters use semiconductor elements, so exercise great care in handling them. Improper handling can cause damage to the equipment.
-  **Caution** Do not change the wiring or remove connectors or the Digital Operator during operation. Doing so can result in personal injury and damage to the equipment.

### ● Daily Inspection

Check the following items with the system in operation.

- The motor should not be vibrating or making unusual noises.
- There should be no abnormal heat generation.
- The ambient temperature should not be too high.
- The output current value shown on the monitor display should not be higher than normal.
- The cooling fan on the bottom of the Inverter should be operating normally.

### ● Periodic Inspection

Check the following items during periodic maintenance. Before beginning inspection, be sure to turn off the power supply. Confirm that the LED indicators on the front panel have all turned OFF, and then wait until at least one minute (or at least three minutes for 30 kW or more) has elapsed before beginning the inspection. Be sure not to touch terminals right after the power has been turned off. Doing so can result in electric shock.

- Terminal screws should not be loose.
- There should be no conductive dust or oil mist on the terminal block or inside the Inverter.
- The Inverter's mounting screws should not be loose.

- No dirt or dust should be accumulating on the heating fan unit.
- No dust should be accumulating on the vents.
- There should be no abnormalities in the outward appearance.
- The control panel cooling fan should be operating normally. (Check to be sure that there are no unusual noises or vibration and that the accumulated operating time has not exceeded the specifications.)

● **Periodic Maintenance of Parts**

The Inverter is configured of many parts, and these parts must be operating properly in order to make full use of the Inverter's functions.

Among the electronic components, there are some that require maintenance depending on their usage conditions. In order to keep the Inverter operating normally over a long period of time, it is necessary to perform period inspections and replace parts according to their service life.

Periodic inspection standards vary depending the Inverter's installation environment and usage conditions.

The Inverter's maintenance periods are noted below. Keep them as reference.

- Cooling fan: 2 to 3 years
- Electrolytic capacitor: 5 years
- Fuses: 10 years

The usage conditions are as follows:

- Ambient temperature 40°C
- Load factor: 80%
- Operating time: 8 hours per day
- Installation: According to instructions in manual.

If the maintenance period is extended, it is recommended that the ambient temperature be lowered and that the power-on time be reduced as much as possible.

**Note** For details regarding maintenance, consult your OMRON sales representative.

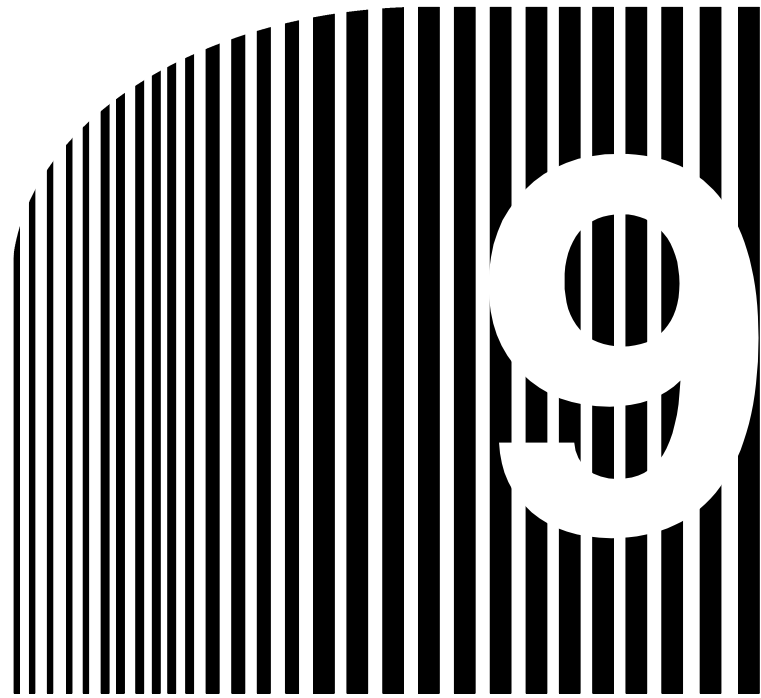

## Chapter 9

### • Specifications •

9-1 Inverter Specifications

9-2 Option Specifications

**9-1 Inverter Specifications**

**General Specifications for 200-V Inverters**

| Model number<br>3G3FV-                              | A2004   | A2007 | A2015 | A2022 | A2037 | A2055 | A2075 | A2110 | A2150 | B2185 | B2220 | B2300 | B2370 | B2450 | B2550 | B2750<br>-E |
|---|---|-------|-------|-------|-------|-------|-------|-------|-------|-------|-------|-------|-------|-------|-------|-------------|
| Max. applica-<br>ble motor ca-<br>pacity (kW)       | 0.4   | 0.75  | 1.5   | 2.2   | 3.7   | 5.5   | 7.5   | 11    | 15    | 18.5  | 22    | 30    | 37    | 45    | 55    | 75          |
| <b>Output characteristics</b>                       |   |       |       |       |       |       |       |       |       |       |       |       |       |       |       |             |
| Rated output<br>capacity<br>(kVA)                   | 1.2   | 2.3   | 3.0   | 4.2   | 6.7   | 9.5   | 13    | 19    | 24    | 30    | 37    | 50    | 61    | 70    | 85    | 110         |
| Rated output<br>current (A)                         | 3.2   | 6.0   | 8.0   | 11    | 17.5  | 25    | 33    | 49    | 64    | 80    | 96    | 130   | 160   | 183   | 224   | 300         |
| Max. output<br>voltage (V)                          | 3-phase, 200 to 230 VAC (Corresponds to input voltage.) |       |       |       |       |       |       |       |       |       |       |       |       |       |       |             |
| Max. output<br>frequency<br>(Hz)                    | 400 Hz (Set by parameter constant.)                     |       |       |       |       |       |       |       |       |       |       |       |       |       |       |             |
| <b>Power supply characteristics</b>                 |   |       |       |       |       |       |       |       |       |       |       |       |       |       |       |             |
| Rated volt-<br>age (V)<br>Rated fre-<br>quency (Hz) | 3-phase, 200 to 230 VAC, 50/60 Hz                       |       |       |       |       |       |       |       |       |       |       |       |       |       |       |             |
| Allowable<br>voltage fluc-<br>tuation               | -15% to 10%   |       |       |       |       |       |       |       |       |       |       |       |       |       |       |             |
| Allowable<br>frequency<br>fluctuation               | ±5%   |       |       |       |       |       |       |       |       |       |       |       |       |       |       |             |
| Power con-<br>sumption (kW)                         | 0.07  | 0.09  | 0.12  | 0.14  | 0.22  | 0.30  | 0.35  | 0.59  | 0.73  | 0.89  | 1.2   | 1.4   | 1.8   | 2.1   | 2.7   | 3.3         |
| Approximate<br>weight (kg)                          | 3.0   | 3.0   | 3.0   | 4.5   | 4.5   | 5.5   | 6.0   | 11    | 11    | 28    | 28    | 61    | 62    | 80    | 80    | 135         |

**Control Characteristics**

| Model number<br>3G3FV-                                   | A2004  | A2007 | A2015 | A2022 | A2037 | A2055 | A2075 | A2110 | A2150 | B2185               | B2220   | B2300 | B2370 | B2450 | B2550 | B2750<br>-E |
|--|--|-------|-------|-------|-------|-------|-------|-------|-------|---------------------|---|-------|-------|-------|-------|-------------|
| <b>Power supply harmonic countermeasures</b>             | DC reactor (option) connection possible.   |       |       |       |       |       |       |       |       | DC reactor built in |   |       |       |       |       |             |
| <b>Control method</b>                                    | Sine wave PWM (high-carrier frequency control)   |       |       |       |       |       |       |       |       |                     |   |       |       |       |       |             |
| <b>Carrier frequency</b>                                 | 0.4 to 15 kHz (2.0 to 15 kHz in vector control)  |       |       |       |       |       |       |       |       |                     | 0.4 to 10 kHz (2.0 to 10 kHz in vector control) |       |       |       |       |             |
| <b>Speed control range</b>                               | 1:100 (1:1000 with PG)   |       |       |       |       |       |       |       |       |                     |   |       |       |       |       |             |
| <b>Speed control precision</b>                           | ±0.2% (±0.02% with PG)   |       |       |       |       |       |       |       |       |                     |   |       |       |       |       |             |
| <b>Speed control response</b>                            | 5 Hz (30 Hz with PG)   |       |       |       |       |       |       |       |       |                     |   |       |       |       |       |             |
| <b>Torque characteristics</b>                            | 150% at 1 Hz (150% at 0 rpm with PG). A torque limit function is incorporated.   |       |       |       |       |       |       |       |       |                     |   |       |       |       |       |             |
| <b>Torque control precision</b>                          | ±5% (with PG)  |       |       |       |       |       |       |       |       |                     |   |       |       |       |       |             |
| <b>Torque control response</b>                           | 40 Hz (with PG)  |       |       |       |       |       |       |       |       |                     |   |       |       |       |       |             |
| <b>Frequency control range</b>                           | 0.1 to 400 Hz  |       |       |       |       |       |       |       |       |                     |   |       |       |       |       |             |
| <b>Frequency precision (temperature characteristics)</b> | Digital commands: ±0.01% (-10° to 40°C)<br>Analog commands: ±0.1% (25°±10°C)   |       |       |       |       |       |       |       |       |                     |   |       |       |       |       |             |
| <b>Frequency setting resolution</b>                      | Digital commands: 0.01 Hz (Less than 100 Hz), 0.1 Hz (100 Hz or higher)<br>Analog commands: 0.03 Hz/60 Hz (11 bits + sign) |       |       |       |       |       |       |       |       |                     |   |       |       |       |       |             |
| <b>Output frequency resolution</b>                       | 0.001 Hz   |       |       |       |       |       |       |       |       |                     |   |       |       |       |       |             |
| <b>Overload capacity</b>                                 | 150% of rated current for one minute   |       |       |       |       |       |       |       |       |                     |   |       |       |       |       |             |
| <b>Frequency setting signal</b>                          | 0 to ±10 VDC (20 kΩ), 0 to 10 VDC (20 kΩ) voltage input or 4 to 20 mA (250 Ω) current input                                |       |       |       |       |       |       |       |       |                     |   |       |       |       |       |             |
| <b>Acceleration/Deceleration time</b>                    | 0.01 to 6000.0 s (4 selectable combinations of independent acceleration and deceleration settings)                         |       |       |       |       |       |       |       |       |                     |   |       |       |       |       |             |
| <b>Braking torque</b>                                    | Approximately 20% (Increment possible with an external braking resistor.)  |       |       |       |       |       |       |       |       |                     |   |       |       |       |       |             |
| <b>Voltage/frequency characteristics</b>                 | Select vector control, one from 15 types of fixed V/f patterns, or set a user V/f pattern.                                 |       |       |       |       |       |       |       |       |                     |   |       |       |       |       |             |

**Protective Functions**

| Model number<br>3G3FV-                                       | A2004  | A2007 | A2015 | A2022 | A2037 | A2055 | A2075 | A2110 | A2150 | B2185 | B2220 | B2300 | B2370 | B2450 | B2550 | B2750<br>-E |
|--|--|-------|-------|-------|-------|-------|-------|-------|-------|-------|-------|-------|-------|-------|-------|-------------|
| <b>Motor protection</b>                                      | Protection by electronic thermal.  |       |       |       |       |       |       |       |       |       |       |       |       |       |       |             |
| <b>Instantaneous overcurrent protection</b>                  | Stops at approx. 200% of rated output current.   |       |       |       |       |       |       |       |       |       |       |       |       |       |       |             |
| <b>Overload protection</b>                                   | Stops in one minute at approx. 150% of rated output current.   |       |       |       |       |       |       |       |       |       |       |       |       |       |       |             |
| <b>Overvoltage protection</b>                                | Stops when main-circuit DC voltage is approx. 410 V.   |       |       |       |       |       |       |       |       |       |       |       |       |       |       |             |
| <b>Undervoltage protection</b>                               | Stops when main-circuit DC voltage is approx. 190 V.   |       |       |       |       |       |       |       |       |       |       |       |       |       |       |             |
| <b>Momentary power interruption compensation (selection)</b> | Stops for 15 ms or more. By selecting the momentary power interruption mode, operation can be continued if power is restored within 2 s. |       |       |       |       |       |       |       |       |       |       |       |       |       |       |             |
| <b>Cooling fin overheating</b>                               | Protection by thermistor.  |       |       |       |       |       |       |       |       |       |       |       |       |       |       |             |



| Model number<br>3G3FV-                 | A2004   | A2007 | A2015 | A2022 | A2037 | A2055 | A2075 | A2110 | A2150 | B2185 | B2220 | B2300 | B2370 | B2450 | B2550 | B2750<br>-E |
|--|---|-------|-------|-------|-------|-------|-------|-------|-------|-------|-------|-------|-------|-------|-------|-------------|
| <b>Grounding protection</b>            | Protection by electronic circuits.                            |       |       |       |       |       |       |       |       |       |       |       |       |       |       |             |
| <b>Charge indicator (internal LED)</b> | Lit when the main circuit DC voltage is approx. 50 V or more. |       |       |       |       |       |       |       |       |       |       |       |       |       |       |             |

**Environment**

| Model number<br>3G3FV-               | A2004   | A2007 | A2015 | A2022 | A2037 | A2055 | A2075 | A2110 | A2150 | B2185                            | B2220 | B2300 | B2370 | B2450 | B2550 | B2750<br>-E |
|--------------------------------------|---|-------|-------|-------|-------|-------|-------|-------|-------|----------------------------------|-------|-------|-------|-------|-------|-------------|
| <b>Location</b>                      | Indoors (no corrosive gas, oil spray, metallic dust, etc.)  |       |       |       |       |       |       |       |       |                                  |       |       |       |       |       |             |
| <b>Ambient operating temperature</b> | -10° to 45°C (NEMA1 type: -10° to 40°C)   |       |       |       |       |       |       |       |       | -10° to 45°C (Open chassis type) |       |       |       |       |       |             |
| <b>Ambient operating humidity</b>    | 90% RH max. (with no condensation)  |       |       |       |       |       |       |       |       |                                  |       |       |       |       |       |             |
| <b>Storage temperature</b>           | -20° to 60°C  |       |       |       |       |       |       |       |       |                                  |       |       |       |       |       |             |
| <b>Altitude</b>                      | 1,000 m max.  |       |       |       |       |       |       |       |       |                                  |       |       |       |       |       |             |
| <b>Insulation resistance</b>         | 5 MΩ min. (Do not carry out the insulation resistance test or withstand voltage test.)                          |       |       |       |       |       |       |       |       |                                  |       |       |       |       |       |             |
| <b>Vibration withstand</b>           | Vibration frequency less than 20 Hz, 9.8 m/s <sup>2</sup> {1G} max.; 20 to 50 Hz, 2 m/s <sup>2</sup> {0.2G} max |       |       |       |       |       |       |       |       |                                  |       |       |       |       |       |             |
| <b>Protective structure</b>          | Both enclosed NEMA1 type and open chassis type: IP00  |       |       |       |       |       |       |       |       | Open chassis type: IP00          |       |       |       |       |       |             |

**General Specifications for 400-V Inverters**

| Model number<br>3G3FV-                            | A4004   | A4007 | A4015 | A4022 | A4037 | A4055 | A4075 | A4110 | A4150 | B4185 | B4220 | B4300 | B4370 | B4450 | B4550 | B4750<br>-E | B411K<br>-E | B416K<br>-E | B418K<br>-E | B422K<br>-E | B430K<br>-E |
|---|---|-------|-------|-------|-------|-------|-------|-------|-------|-------|-------|-------|-------|-------|-------|-------------|-------------|-------------|-------------|-------------|-------------|
| <b>Max. applicable motor capacity (kW)</b>        | 0.4   | 0.75  | 1.5   | 2.2   | 3.7   | 5.5   | 7.5   | 11    | 15    | 18.5  | 22    | 30    | 37    | 45    | 55    | 75          | 110         | 160         | 185         | 220         | 300         |
| <b>Output characteristics</b>                     |   |       |       |       |       |       |       |       |       |       |       |       |       |       |       |             |             |             |             |             |             |
| <b>Rated output capacity (kVA)</b>                | 1.4   | 2.6   | 3.7   | 4.7   | 6.1   | 11    | 14    | 21    | 26    | 31    | 37    | 50    | 61    | 73    | 98    | 130         | 170         | 230         | 260         | 340         | 460         |
| <b>Rated output current (A)</b>                   | 1.8   | 3.4   | 4.8   | 6.2   | 8.0   | 14    | 18    | 27    | 34    | 41    | 48    | 65    | 80    | 96    | 128   | 165         | 224         | 302         | 340         | 450         | 605         |
| <b>Max. output voltage (V)</b>                    | 3-phase, 380 to 460 VAC (Corresponds to input voltage.) |       |       |       |       |       |       |       |       |       |       |       |       |       |       |             |             |             |             |             |             |
| <b>Max. output frequency (Hz)</b>                 | 400 Hz (Set by parameter constant.)                     |       |       |       |       |       |       |       |       |       |       |       |       |       |       |             |             |             |             |             |             |
| <b>Power supply characteristics</b>               |   |       |       |       |       |       |       |       |       |       |       |       |       |       |       |             |             |             |             |             |             |
| <b>Rated voltage (V)<br/>Rated frequency (Hz)</b> | 3-phase, 380 to 460 VAC, 50/60 Hz                       |       |       |       |       |       |       |       |       |       |       |       |       |       |       |             |             |             |             |             |             |
| <b>Allowable voltage fluctuation</b>              | -15% to 10%   |       |       |       |       |       |       |       |       |       |       |       |       |       |       |             |             |             |             |             |             |
| <b>Allowable frequency fluctuation</b>            | ±5%   |       |       |       |       |       |       |       |       |       |       |       |       |       |       |             |             |             |             |             |             |
| <b>Power consumption (kW)</b>                     | 0.06  | 0.09  | 0.11  | 0.13  | 0.15  | 0.22  | 0.36  | 0.46  | 0.57  | 0.66  | 0.88  | 1.1   | 1.3   | 1.4   | 1.9   | 2.4         | 3.1         | 4.2         | 5.0         | 6.9         | 9.8         |
| <b>Approximate weight (kg)</b>                    | 3.0   | 3.0   | 4.0   | 4.5   | 4.5   | 6.0   | 6.0   | 11    | 11    | 27    | 27    | 44    | 44    | 44    | 79    | 80          | 135         | 145         | 360         | 360         | 420         |

Control Characteristics

| Model number<br>3G3FV-                            | A4004  | A4007 | A4015 | A4022 | A4037 | A4055 | A4075 | A4110 | A4150 | B4185               | B4220 | B4300 | B4370   | B4450 | B4550 | B4750<br>-E | B411K<br>-E                                       | B416K<br>-E | B418K<br>-E | B422K<br>-E | B430K<br>-E |
|---|--|-------|-------|-------|-------|-------|-------|-------|-------|---------------------|-------|-------|---|-------|-------|-------------|---|-------------|-------------|-------------|-------------|
| Power supply harmonic countermeasures             | DC reactor (option) connection possible.   |       |       |       |       |       |       |       |       | DC reactor built in |       |       |   |       |       |             |   |             | No item     |             |             |
| Control method                                    | Sine wave PWM (high-carrier frequency control)   |       |       |       |       |       |       |       |       |                     |       |       |   |       |       |             |   |             |             |             |             |
| Carrier frequency                                 | 0.4 to 15 kHz (2.0 to 15 kHz in vector control)  |       |       |       |       |       |       |       |       |                     |       |       | 0.4 to 10 kHz (2.0 to 10 kHz in vector control) |       |       |             | 0.4 to 2.5 kHz (2.0 to 2.5 kHz in vector control) |             |             |             |             |
| Speed control range                               | 1:100 (1:1000 with PG)   |       |       |       |       |       |       |       |       |                     |       |       |   |       |       |             |   |             |             |             |             |
| Speed control precision                           | ±0.2% (±0.02% with PG)   |       |       |       |       |       |       |       |       |                     |       |       |   |       |       |             |   |             |             |             |             |
| Speed control response                            | 5 Hz (30 Hz with PG)   |       |       |       |       |       |       |       |       |                     |       |       |   |       |       |             |   |             |             |             |             |
| Torque characteristics                            | 150% at 1 Hz (150% at 0 rpm with PG). A torque limit function is incorporated.   |       |       |       |       |       |       |       |       |                     |       |       |   |       |       |             |   |             |             |             |             |
| Torque control precision                          | ±5% (with PG)  |       |       |       |       |       |       |       |       |                     |       |       |   |       |       |             |   |             |             |             |             |
| Torque control response                           | 40 Hz (with PG)  |       |       |       |       |       |       |       |       |                     |       |       |   |       |       |             |   |             |             |             |             |
| Frequency control range                           | 0.1 to 400 Hz  |       |       |       |       |       |       |       |       |                     |       |       |   |       |       |             |   |             |             |             |             |
| Frequency precision (temperature characteristics) | Digital commands: ±0.01% (-10° to 40°C)<br>Analog commands: ±0.1% (25±10°C)  |       |       |       |       |       |       |       |       |                     |       |       |   |       |       |             |   |             |             |             |             |
| Frequency setting resolution                      | Digital commands: 0.01 Hz (Less than 100 Hz), 0.1 Hz (100 Hz or higher)<br>Analog commands: 0.03 Hz/60 Hz (11 bits + sign) |       |       |       |       |       |       |       |       |                     |       |       |   |       |       |             |   |             |             |             |             |
| Output frequency resolution                       | 0.001 Hz   |       |       |       |       |       |       |       |       |                     |       |       |   |       |       |             |   |             |             |             |             |
| Overload capacity                                 | 150% of rated current for one minute   |       |       |       |       |       |       |       |       |                     |       |       |   |       |       |             |   |             |             |             |             |
| Frequency setting signal                          | 0 to ±10 VDC (20 kΩ), 0 to 10 VDC (20 kΩ) voltage input or 4 to 20 mA (250 Ω) current input                                |       |       |       |       |       |       |       |       |                     |       |       |   |       |       |             |   |             |             |             |             |
| Acceleration/Deceleration time                    | 0.01 to 6000.0 s (4 selectable combinations of independent acceleration and deceleration settings)                         |       |       |       |       |       |       |       |       |                     |       |       |   |       |       |             |   |             |             |             |             |
| Braking torque                                    | Approximately 20% (Increment possible with an external braking resistor.)  |       |       |       |       |       |       |       |       |                     |       |       |   |       |       |             |   |             |             |             |             |
| Voltage/frequency characteristics                 | Select vector control, one from 15 types of fixed V/f patterns, or set a user V/f pattern.                                 |       |       |       |       |       |       |       |       |                     |       |       |   |       |       |             |   |             |             |             |             |

Protective Functions

| Model number<br>3G3FV-                                | A4004  | A4007 | A4015 | A4022 | A4037 | A4055 | A4075 | A4110 | A4150 | B4185 | B4220 | B4300 | B4370 | B4450 | B4550 | B4750<br>-E | B411K<br>-E | B416K<br>-E | B418K<br>-E | B422K<br>-E | B430K<br>-E |
|---|--|-------|-------|-------|-------|-------|-------|-------|-------|-------|-------|-------|-------|-------|-------|-------------|-------------|-------------|-------------|-------------|-------------|
| Motor protection                                      | Protection by electronic thermal.  |       |       |       |       |       |       |       |       |       |       |       |       |       |       |             |             |             |             |             |             |
| Instantaneous overcurrent protection                  | Stops at approx. 200% of rated output current.   |       |       |       |       |       |       |       |       |       |       |       |       |       |       |             |             |             |             |             |             |
| Overload protection                                   | Stops in one minute at approx. 150% of rated output current.   |       |       |       |       |       |       |       |       |       |       |       |       |       |       |             |             |             |             |             |             |
| Overvoltage protection                                | Stops when main-circuit DC voltage is approx. 820 V.   |       |       |       |       |       |       |       |       |       |       |       |       |       |       |             |             |             |             |             |             |
| Undervoltage protection                               | Stops when main-circuit DC voltage is approx. 380 V.   |       |       |       |       |       |       |       |       |       |       |       |       |       |       |             |             |             |             |             |             |
| Momentary power interruption compensation (selection) | Stops for 15 ms or more. By selecting the momentary power interruption mode, operation can be continued if power is restored within 2 s. |       |       |       |       |       |       |       |       |       |       |       |       |       |       |             |             |             |             |             |             |
| Cooling fin overheating                               | Protection by thermistor.  |       |       |       |       |       |       |       |       |       |       |       |       |       |       |             |             |             |             |             |             |
| Grounding protection                                  | Protection by electronic circuits.   |       |       |       |       |       |       |       |       |       |       |       |       |       |       |             |             |             |             |             |             |
| Charge indicator (internal LED)                       | Lit when the main circuit DC voltage is approx. 50 V or more.  |       |       |       |       |       |       |       |       |       |       |       |       |       |       |             |             |             |             |             |             |

**Environment**



| Model number<br>3G3FV-        | A4004   | A4007 | A4015 | A4022 | A4037 | A4055 | A4075 | A4110 | A4150 | B4185 | B4220                            | B4300 | B4370 | B4450 | B4550 | B4750<br>-E | B411K<br>-E | B416K<br>-E | B418K<br>-E | B422K<br>-E | B430K<br>-E |
|-------------------------------|---|-------|-------|-------|-------|-------|-------|-------|-------|-------|----------------------------------|-------|-------|-------|-------|-------------|-------------|-------------|-------------|-------------|-------------|
| Location                      | Indoors (no corrosive gas, oil spray, metallic dust, etc.)  |       |       |       |       |       |       |       |       |       |                                  |       |       |       |       |             |             |             |             |             |             |
| Ambient operating temperature | -10° to 45°C (NEMA1 type: -10° to 40°C)   |       |       |       |       |       |       |       |       |       | -10° to 45°C (Open chassis type) |       |       |       |       |             |             |             |             |             |             |
| Ambient operating humidity    | 90% RH max. (with no condensation)  |       |       |       |       |       |       |       |       |       |                                  |       |       |       |       |             |             |             |             |             |             |
| Storage temperature           | -20° to 60°C  |       |       |       |       |       |       |       |       |       |                                  |       |       |       |       |             |             |             |             |             |             |
| Altitude                      | 1,000 m max.  |       |       |       |       |       |       |       |       |       |                                  |       |       |       |       |             |             |             |             |             |             |
| Insulation resistance         | 5 MΩ min. (Do not carry out the insulation resistance test or withstand voltage test.)                          |       |       |       |       |       |       |       |       |       |                                  |       |       |       |       |             |             |             |             |             |             |
| Vibration withstand           | Vibration frequency less than 20 Hz, 9.8 m/s <sup>2</sup> {1G} max.; 20 to 50 Hz, 2 m/s <sup>2</sup> {0.2G} max |       |       |       |       |       |       |       |       |       |                                  |       |       |       |       |             |             |             |             |             |             |
| Protective structure          | Both enclosed NEMA1 type and open chassis type: IP00  |       |       |       |       |       |       |       |       |       | Open chassis type: IP00          |       |       |       |       |             |             |             |             |             |             |

9-2 Option Specifications

**Separately Mounted Options**





K3TJ-V11 □  
Scaling Meter

3G3IV-PJVOP96 □ Analog Operator  
(standard - steel)

3G3IV-PJVOP95 □ Analog Operator  
(compact - plastic)

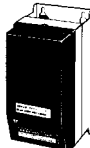
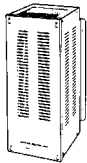

**Dedicated Options**

3G3IV-PCDBR □ Braking Unit

3G3IV-PLKEB □ Braking Resistor Unit

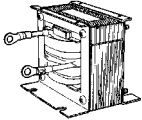

3G3IV-PERF 150WJ □ Braking Resistor

3G3HV-PUZDAB □ DC Reactor

3G3FV-PCN □25 Digital Operator Connection Cable

**Recommended Options**

3G3IV-PUZBAB □ AC Reactor

3G3IV-PHF □ Input Noise Filter



R S T

Power Supply  
3-phase, 200 VAC (200V-class)  
3-phase, 400 VAC (400V-class)

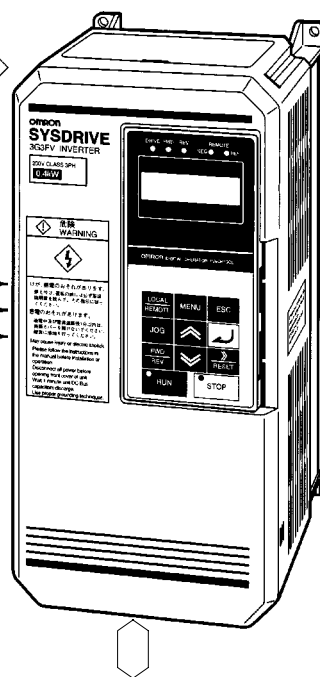

**Recommended Options**

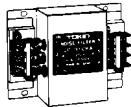





3G3IV-PLF □ Output Noise Filter

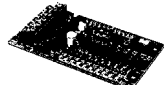
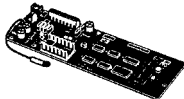
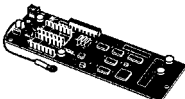

IM

3-phase Induction Motor

**Optional Cards**

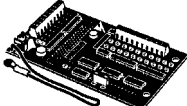
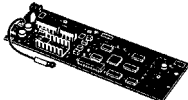
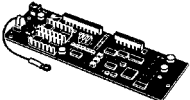
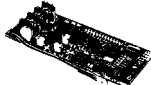
|  |  |   |   |   |   |
|--|--|---|---|---|---|
| <br>3G3IV-PAI14U<br>Analog Reference Card | <br>3G3IV-PDI08<br>Digital Reference Card   | <br>3G3FV-PPGA2<br>PG Speed Control Card | <br>3G3FV-PPGD2<br>PG Speed Control Card | <br>3G3IV-PAO08<br>Analog Monitor Card | <br>3G3IV-PPO36F<br>Pulse Monitor Card |
| <br>3G3IV-PAI14B<br>Analog Reference Card | <br>3G3FV-PDI16H2<br>Digital Reference Card | <br>3G3FV-PPGB2<br>PG Speed Control Card | <br>3G3FV-PPGX2<br>PG Speed Control Card | <br>3G3IV-PAO12<br>Analog Monitor Card |   |

■ Separately Mounted Options

| Name                                    | Model          | Descriptions  |
|---|----------------|---|
| Scaling Meter                           | K3TJ-V11□      | Connects to the multi-functional analog output of the Inverter. It displays the rotational speed of a machine or the line speed.  |
| Analog Operator (steel: standard type)  | 3G3IV-PJVOP96□ | Allows frequency reference settings and ON/OFF operation control to be performed by analog commands from a remote location (50 m max.). Frequency counter specifications: 75 Hz, 150 Hz, 220 Hz |
| Analog Operator (plastic: compact type) | 3G3IV-PJVOP95□ | Allows frequency reference settings and ON/OFF operation control to be performed by analog commands from a remote location (50 m max.). Frequency counter specifications: 60/120 Hz, 90/180Hz   |

■ Dedicated Options

| Name                              | Model                  | Descriptions   |
|-----------------------------------|------------------------|--|
| Braking Unit                      | 3G3IV-PCDBR□           | Used in combination with a Braking Resistor Unit for reducing motor's deceleration time. Not necessary for 200V-class models of 7.5 kW max. or 400V-class models of 15 kW max. |
| Braking Resistor Unit             | 3G3IV-PLKEB□           | Consumes the regenerative energy of the motor and reduces the deceleration time of the motor.  |
| Braking Resistor                  | 3G3IV-PERF<br>150WJ□01 | Used for 200-V class of 3.7 kW max. and 400-V class of 2.2 kW max. Consumes the regenerative energy of the motor and reduces the deceleration time of the motor.               |
| DC Reactor                        | 3G3HV-PUZDAB□          | Suppresses the harmonic currents of the 3G3FV and improves the power factor of the 3G3FV. Models of 18.5 kW or more have a built-in DC Reactor.                                |
| Digital Operator Connection Cable | 3G3FV-PCN125<br>(1 m)  | A dedicated cable for the 3G3FV Series. Used to connect the 3G3FV and Digital Operator when they are separated.  |
|                                   | 3G3FV-PCN325<br>(3 m)  |  |

■ **Optional Cards**

| Name                   | Model         | Descriptions   |
|------------------------|---------------|--|
| Analog Reference Card  | 3G3IV-PAI14U  | The 3G3FV incorporates analog input terminals for frequency references with a resolution of 1/2,048. This card increases the resolution to 1/16,384.   |
|                        | 3G3IV-PAI14B  | Allows -10- to 10-VDC frequency reference inputs with a resolution of 1/8,192 + sign. Forward and reverse rotation is selected with the polarity of the input voltage.   |
| Digital Reference Card | 3G3IV-PDI08   | Used to set frequency references in 2-digit BCD or 8-bit binary.   |
|                        | 3G3FV-PDI16H2 | Used to set frequency references with 16 or 12 bits (switchable). A parameter setting can be used to select BCD or binary data. The card incorporates a 24-VDC battery (8 mA max.).  |
| Analog Monitor Card    | 3G3IV-PAO08   | Makes it possible to use the analog output of the terminals as control signals. The card, which has two-point, 0 to 10 V analog output, is used to monitor the output frequency, output current, output voltage reference, or DC voltage of the 3G3FV. The 3G3IV-PAO08 has an output resolution of 1/256 (output voltage of 0 to 10 V) and the 3G3IV-PAO12 has an output resolution of 1/2,048 (output voltage of 0 to ±10 V). |
|                        | 3G3IV-PAO12   |  |
| Pulse Monitor Card     | 3G3IV-PPO36F  | Used to output pulse-train signals according to the output frequency of the 3G3FV. The pulse-train signals can be input to another device such as a frequency meter or counter.  |
| PG Speed Control Card  | 3G3FV-PPGA2   | Used for V/f control using the PG at a maximum response frequency of 30 kHz for phase-A (single) pulse input for open-collector output. Pulse monitor output is incorporated.  |
|                        | 3G3FV-PPGB2   | Used for vector control using the PG at a maximum response frequency of 30 kHz for phase-A/phase-B inputs for open-collector output. Pulse monitor output is incorporated.   |
|                        | 3G3FV-PPGD2   | Used for V/f control using the PG at a maximum response frequency of 300 kHz for phase-A (single) pulse input and RS-422 line driver input. Pulse monitor output is incorporated.  |
|                        | 3G3FV-PPGX2   | Used for vector control using the PG at a maximum response frequency of 300 kHz for phase-A/phase-B/phase-Z pulse inputs and RS-422 line driver input. Pulse monitor output is incorporated.   |

**Note 1.** Use the Digital Reference Card when setting frequencies digitally from a PC's Output Unit or thumbwheel switches.

**Note 2.** Use the PG Speed Control Card for speed control with the Pulse Generator (PG).

■ **Recommended Options**

| Name                | Model         | Descriptions   |
|---------------------|---------------|--|
| AC Reactor          | 3G3IV-PUZBAB□ | Used if the harmonic currents of the 3G3FV must be suppressed or the capacity of the power supply connected to the 3G3FV is much larger than the capacity of the 3G3FV. The AC Reactor improves the power factor of the 3G3FV. |
| Input Noise Filter  | 3G3IV-PHF□    | Used to eliminate noise coming into the inverter from the power supply line and to reduce noise flowing from the inverter into the power supply line. Connect to the power supply input side.                                  |
| Output Noise Filter | 3G3IV-PLF□    | Used to suppress noise that is generated by the inverter from affecting the power supply side. Connect to the motor output side.   |

■ Separately Mounted Options

● Scaling Meter

K3TJ-V11



By connecting to the Inverter's multi-function analog output (analog monitor), it is possible to display the number of rotations, line speed, and so on.

● Standard Models

| Model      | Control power supply               | Display             |
|------------|------------------------------------|---------------------|
| K3TJ-V111R | 100 to 200 VAC                     | Red LED indicator   |
| K3TJ-V111G |                                    | Green LED indicator |
| K3TJ-V116R | 24 VDC with insulation (See note.) | Red LED indicator   |
| K3TJ-V116G |                                    | Green LED indicator |

**Note** The power supply circuit and input circuit are insulated.

● Standard Specifications

|  |   |
|--|---|
| Sampling time                                  | 0.5 s   |
| Display refresh period                         | 0.5 s   |
| Process value averaging method                 | Simple average or movement average  |
| Number of process value averaging operations   | 1, 2, 4, or 8 times   |
| Max. displayed digits                          | 4 digits (–1,999 to +9,999)   |
| Display  | 7-segment red or green LED with character height of 14.2 mm                           |
| Decimal display                                | Selected by the Up and Down Keys and parameter selector                               |
| Scaling function                               | Shift/Scaling adjustment is possible with the Up and Down Keys and parameter selector |
| Scaling range                                  | –1,999 to +9,999  |
| Zero-limit range                               | 0 to 99 digits  |
| Overflow display                               | Flashes   |
| Zero-suppress function                         | Yes   |
| External control                               | Process value hold (by short-circuiting the rear terminals)                           |
| Enclosure rating (conforming to IEC standards) | Front panel: IP51 (see note)<br>Case: IP20<br>Terminals: IP00                         |
| Memory protection                              | Non-volatile memory (no backup battery required)                                      |

**Note** IP51 ensured when the optional K32-L49SC Water-resistive Soft Front Cover is used and IP50 when it is not.

● **Wiring Example**

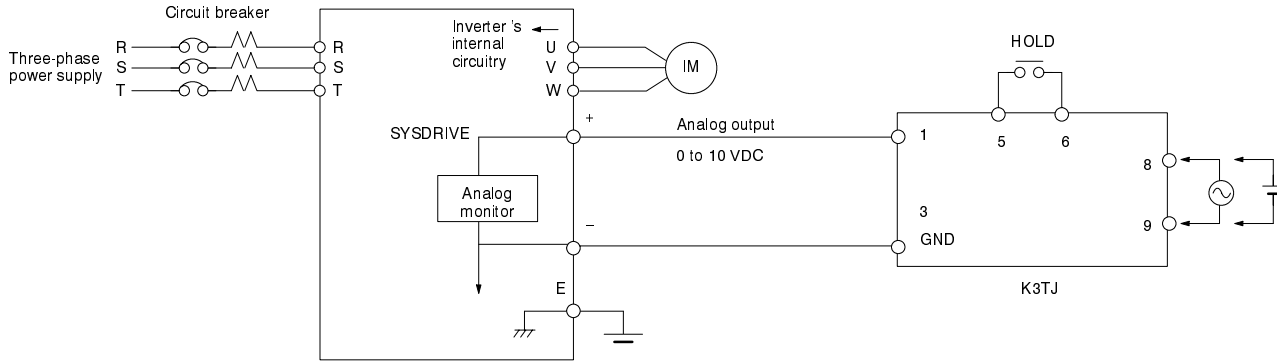

● **External Dimensions**

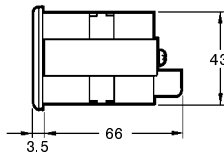
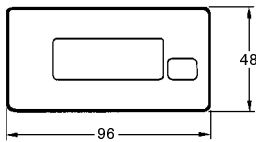
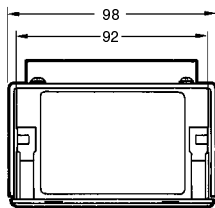

Weight: 200 g

**Panel Cutouts (Recommended)**

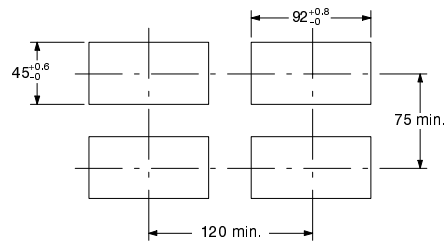

**LED Display Character Size**

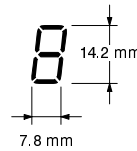

● **Analog Operators**

**3G3IV-PJVOP96□ Analog Operator (Standard Steel-plate Type)**

The 3G3IV-PJVOP96□ Analog Operator is a control panel that allows frequency and run/stop operation by analog commands from a distance (50 m). Frequency scale: 75 Hz, 150 Hz, 220 Hz.

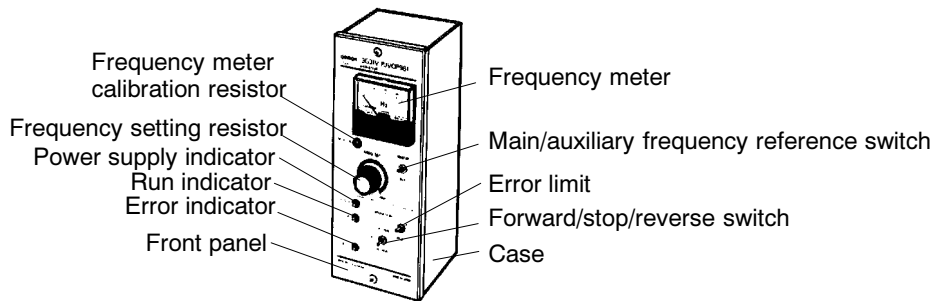

● **Standard Models**

| Model          | Frequency meter specifications |
|----------------|--------------------------------|
| 3G3IV-PJVOP961 | DCF-6A 3 V 1 mA 75 Hz          |
| 3G3IV-PJVOP962 | DCF-6A 3 V 1 mA 150 Hz         |
| 3G3IV-PJVOP963 | DCF-6A 3 V 1 mA 220 Hz         |



● External Dimensions (mm)

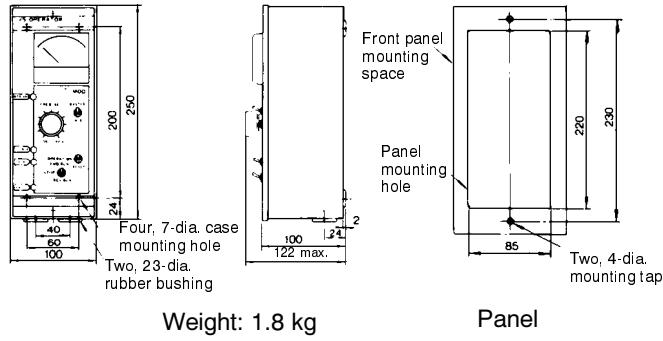

**3G3IV-PJVOP95□ Analog Operator (Compact Plastic Type)**

The 3G3IV-PJVOP95□ Analog Operator is a control panel that allows frequency and run/stop operation by analog commands from a distance (50 m). Frequency scale: 60/120 Hz, 90/180 Hz.

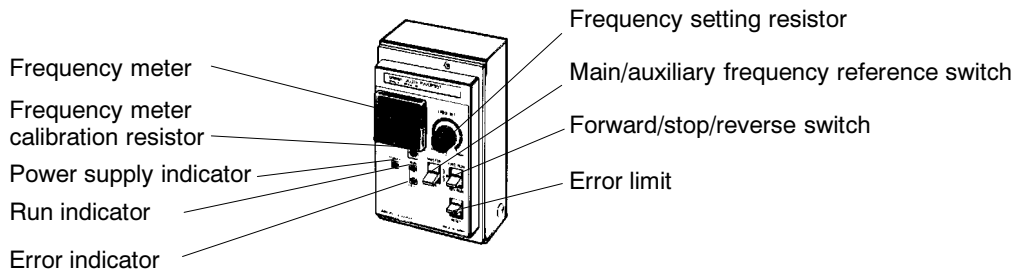

● Standard Models

| Model          | Frequency meter specifications |
|----------------|--------------------------------|
| 3G3IV-PJVOP951 | TRM-45 3 V 1 mA 60/120 Hz      |
| 3G3IV-PJVOP952 | TRM-45 3 V 1 mA 90/180 Hz      |

● External Dimensions (mm)

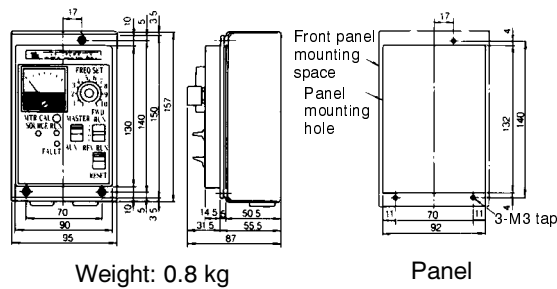

■ Dedicated Options

● Braking Unit (Yaskawa Electric)

**3G3IV-PCDBR□**

The 3G3IV-PCDBR□ is used in combination with a Braking Resistor Unit to shorten the motor's deceleration time. It is not serviceable at 200-V-class, 5 kW, or 400-V-class, 15 kW, or less.



● Standard Models

| Inverter      |                                     | Braking Unit    |             |
|---------------|-------------------------------------|-----------------|-------------|
| Voltage class | Max. applicable motor capacity (kW) | Model           | Number used |
| 200-V class   | 11                                  | 3G3IV-PCDBR2015 | 1           |
|               | 15                                  | 3G3IV-PCDBR2015 | 1           |
|               | 18.5                                | 3G3IV-PCDBR2022 | 1           |
|               | 22                                  | 3G3IV-PCDBR2022 | 1           |
|               | 30                                  | 3G3IV-PCDBR2015 | 2           |
|               | 37                                  | 3G3IV-PCDBR2015 | 2           |
|               | 45                                  | 3G3IV-PCDBR2022 | 2           |
|               | 55                                  | 3G3IV-PCDBR2022 | 2           |
|               | 75                                  | 3G3IV-PCDBR2022 | 3           |
| 400-V class   | 18.5                                | 3G3IV-PCDBR4030 | 1           |
|               | 22                                  | 3G3IV-PCDBR4030 | 1           |
|               | 30                                  | 3G3IV-PCDBR4030 | 1           |
|               | 37                                  | 3G3IV-PCDBR4045 | 1           |
|               | 45                                  | 3G3IV-PCDBR4045 | 1           |
|               | 55                                  | 3G3IV-PCDBR4030 | 2           |
|               | 75                                  | 3G3IV-PCDBR4045 | 2           |
|               | 110                                 | 3G3IV-PCDBR4030 | 3           |
|               | 160                                 | 3G3IV-PCDBR4045 | 4           |
|               | 185                                 | 3G3IV-PCDBR4045 | 4           |
|               | 220                                 | 3G3IV-PCDBR4045 | 5           |
|               | 300                                 | 3G3IV-PCDBR4045 | 6           |

● Braking Unit Dimensions (mm)

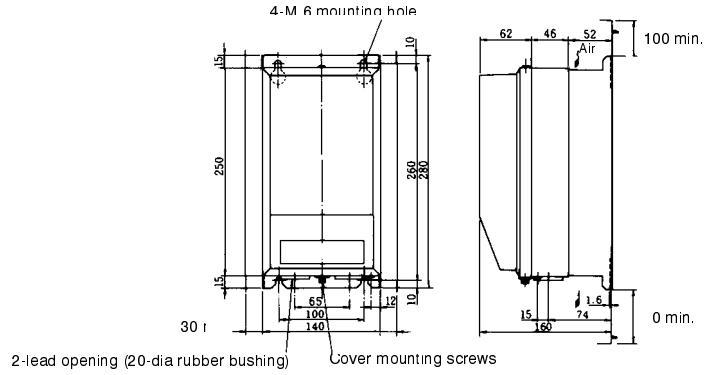

Weight: 15 kg (3G3IV-PCDBR2015)

● Braking Resistor Unit (Yaskawa Electric)

**3G3IV-PLKEB□**

The 3G3IV-PLKEB□ shortens deceleration time by consuming the motor's regenerative energy by means of a resistor. (Usage rate: 10% ED)

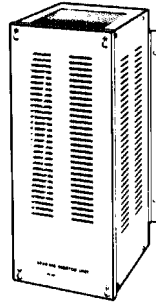

● Standard Models

| Inverter      |  | 3G3IV-PLKEB□ | Resistor specifications<br>(For one Unit) | Number of Units<br>(See note.) |             | Approx. braking torque<br>(10% ED) |
|---------------|--|--------------|---|--------------------------------|-------------|------------------------------------|
| Voltage class | Maximum applicable motor capacity (kW) |              |   | Used                           | Connectible |                                    |
|               |  |              |   |                                |             |                                    |
|               |  | 20P7         | 70 W 200 Ω                                | 1                              | 4           | 125%                               |
|               |  | 21P5         | 260 W 100 Ω                               | 1                              | 5           | 125%                               |
|               |  | 22P2         | 260 W 70 Ω                                | 1                              | 7           | 120%                               |
|               |  | 23P7         | 390 W 40 Ω                                | 1                              | 4           | 125%                               |
|               |  | 25P5         | 520 W 30 Ω                                | 1                              | 3           | 115%                               |
|               |  | 27P5         | 780 W 20 Ω                                | 1                              | 2           | 125%                               |
|               |  | 2011         | 2400 W 13.6 Ω                             | 1                              | 1           | 125%                               |
|               |  | 2015         | 3000 W 10 Ω                               | 1                              | 1           | 125%                               |
|               |  | 2018         | 4800 W 8 Ω                                | 1                              | 1           | 125%                               |
|               |  | 2022         | 4800 W 6.8 Ω                              | 1                              | 1           | 125%                               |
|               |  | 2015         | 3000 W 10 Ω                               | 2                              | 1           | 125%                               |
|               |  | 2015         | 3000 W 10 Ω                               | 2                              | 1           | 100%                               |
|               |  | 2022         | 4800 W 6.8 Ω                              | 2                              | 1           | 120%                               |
|               |  | 2022         | 4800 W 6.8 Ω                              | 2                              | 1           | 100%                               |
|               |  | 2022         | 4800 W 6.8 Ω                              | 3                              | 1           | 110%                               |
| 400-V class   |  | 40P7         | 70 W 750 Ω                                | 1                              | 11          | 230%                               |
|               |  | 40P7         | 70 W 750 Ω                                | 1                              | 11          | 130%                               |
|               |  | 41P5         | 260 W 400 Ω                               | 1                              | 6           | 125%                               |
|               |  | 42P2         | 260 W 250 Ω                               | 1                              | 7           | 135%                               |
|               |  | 43P7         | 390 W 150 Ω                               | 1                              | 4           | 135%                               |
|               |  | 45P5         | 520 W 100 Ω                               | 1                              | 3           | 135%                               |
|               |  | 47P5         | 780 W 75 Ω                                | 1                              | 2           | 130%                               |
|               |  | 4011         | 1040 W 50 Ω                               | 1                              | 2           | 135%                               |
|               |  | 4015         | 1560 W 40 Ω                               | 1                              | 2           | 125%                               |
|               |  | 4018         | 4800 W 32 Ω                               | 1                              | 1           | 125%                               |
|               |  | 4022         | 4800 W 27.2 Ω                             | 1                              | 1           | 125%                               |
|               |  | 4030         | 6000 W 20 Ω                               | 1                              | 1           | 125%                               |
|               |  | 4037         | 9600 W 16 Ω                               | 1                              | 1           | 125%                               |
|               |  | 4045         | 9600 W 13.6 Ω                             | 1                              | 1           | 125%                               |
|               |  | 4030         | 6000 W 20 Ω                               | 2                              | 1           | 135%                               |
|               |  | 4045         | 9600 W 13.6 Ω                             | 2                              | 1           | 145%                               |
|               |  | 4030         | 6000 W 20 Ω                               | 3                              | 1           | 100%                               |
|               |  | 4045         | 9600 W 13.6 Ω                             | 4                              | 1           | 140%                               |
|               |  | 4045         | 9600 W 13.6 Ω                             | 4                              | 1           | 120%                               |
|               |  | 4045         | 9600 W 13.6 Ω                             | 5                              | 1           | 125%                               |
|               |  | 4045         | 9600 W 13.6 Ω                             | 6                              | 1           | 110%                               |

**Note** The “connectable number of units” indicates the maximum number of Braking Resistor Units that can be connected to a single Inverter or Braking Unit.

• Braking Resistor Unit Dimensions (mm)

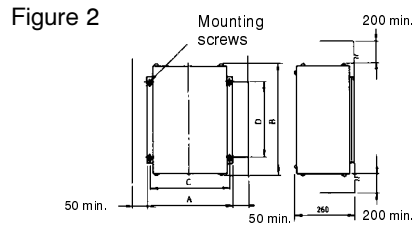
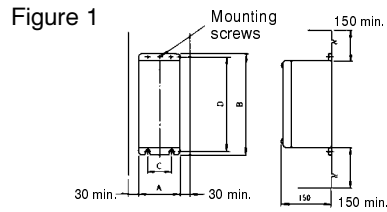

• 200-V Class

| 3G3IV-PLKEB□ | Figure | Dimensions (mm) |     |     |     |        | Screws | Weight (kg) |
|--------------|--------|-----------------|-----|-----|-----|--------|--------|-------------|
|              |        | A               | B   | C   | D   |        |        |             |
| 20P7         | 1      | 105             | 275 | 50  | 260 | M5 x 3 | 3.0    |             |
| 21P5         | 1      | 130             | 350 | 75  | 335 | M5 x 4 | 4.5    |             |
| 22P2         | 1      | 130             | 350 | 75  | 335 | M5 x 4 | 4.5    |             |
| 23P7         | 1      | 130             | 350 | 75  | 335 | M5 x 4 | 5.0    |             |
| 25P5         | 1      | 250             | 350 | 200 | 335 | M6 x 4 | 7.5    |             |
| 27P5         | 1      | 250             | 350 | 200 | 335 | M6 x 4 | 8.5    |             |
| 2011         | 2      | 266             | 543 | 246 | 340 | M8 x 4 | 10     |             |
| 2015         | 2      | 356             | 543 | 336 | 340 | M8 x 4 | 15     |             |
| 2018         | 2      | 446             | 543 | 426 | 340 | M8 x 4 | 19     |             |
| 2022         | 2      | 446             | 543 | 426 | 340 | M8 x 4 | 19     |             |

• 400-V Class

| 3G3IV-PLKEB□ | Figure | Dimensions (mm) |     |     |     |        | Screws | Weight |
|--------------|--------|-----------------|-----|-----|-----|--------|--------|--------|
|              |        | A               | B   | C   | D   |        |        |        |
| 40P7         | 1      | 105             | 275 | 50  | 260 | M5 x 3 | 3.0    |        |
| 41P5         | 1      | 130             | 350 | 75  | 335 | M5 x 4 | 4.5    |        |
| 42P2         | 1      | 130             | 350 | 75  | 335 | M5 x 4 | 4.5    |        |
| 43P7         | 1      | 130             | 350 | 75  | 335 | M5 x 4 | 5.0    |        |
| 45P5         | 1      | 250             | 350 | 200 | 335 | M6 x 4 | 7.5    |        |
| 47P5         | 1      | 250             | 350 | 200 | 335 | M6 x 4 | 8.5    |        |
| 4011         | 2      | 350             | 412 | 330 | 325 | M6 x 4 | 16     |        |
| 4015         | 2      | 350             | 412 | 330 | 325 | M6 x 4 | 18     |        |
| 4018         | 2      | 446             | 543 | 426 | 340 | M8 x 4 | 19     |        |
| 4022         | 2      | 446             | 543 | 426 | 340 | M8 x 4 | 19     |        |
| 4030         | 2      | 356             | 956 | 336 | 740 | M8 x 4 | 25     |        |
| 4037         | 2      | 446             | 956 | 426 | 740 | M8 x 4 | 33     |        |
| 4045         | 2      | 446             | 956 | 426 | 740 | M8 x 4 | 33     |        |

● Braking Resistor (Yaskawa Electric)

**3G3IV-PERF150WJ** □

The 3G3IV-PERF150WJ □ shortens deceleration time by consuming the motor's regenerative energy by means of a resistor. (Usage rate: 3% ED)



● Standard Models

| Inverter      |  | Braking Resistor  |                         |             | Approx. braking torque (3% ED) |
|---------------|--|-------------------|-------------------------|-------------|--------------------------------|
| Voltage class | Maximum applicable motor capacity (kW) | 3G3IV-PERF150WJ □ | Resistor specifications | Number used |                                |
| 200-V class   | 0.4                                    | 201               | 150 W 200 Ω             | 1           | 220%                           |
|               | 0.75                                   | 201               | 150 W 200 Ω             | 1           | 125%                           |
|               | 1.5                                    | 101               | 150 W 100 Ω             | 1           | 125%                           |
|               | 2.2                                    | 700               | 150 W 70 Ω              | 1           | 120%                           |
|               | 3.7                                    | 620               | 150 W 62 Ω              | 1           | 100%                           |
| 400-V class   | 0.4                                    | 751               | 150 W 750 Ω             | 1           | 230%                           |
|               | 0.75                                   | 751               | 150 W 750 Ω             | 1           | 130%                           |
|               | 1.5                                    | 401               | 150 W 400 Ω             | 1           | 125%                           |
|               | 2.2                                    | 301               | 150 W 300 Ω             | 1           | 115%                           |
|               | 3.7                                    | 201               | 150 W 200 Ω             | 1           | 110% (See note.)               |

**Note** Usage rate: 2%.

● External Dimensions (mm)

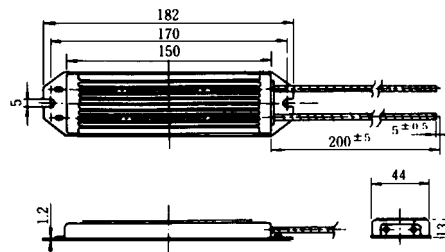

● Digital Operator Connecting Cable

**3G3FV-PCN□25**

This is a special cable for the 3G3FV Series. It is used for connecting the Inverter to the Digital Operator. The cable length can be either 1 or 3 meters.

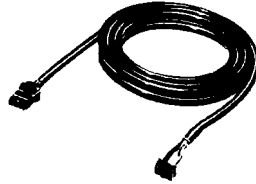

● Standard Models

|              |                        |
|--------------|------------------------|
| 3G3FV-PCN125 | Cable length: 1 meter  |
| 3G3FV-PCN325 | Cable length: 3 meters |

● DC Reactor (Yaskawa Electric)

**3G3HV-PUZDAB□A□MH**

This DC Reactor is used for controlling harmonic current generated by the Inverter. It is more effective than an AC reactor, and can be used in conjunction. It is intended for use with Inverters of 15 kW or less. (It is built into Inverters of 18.5 kW and over.)

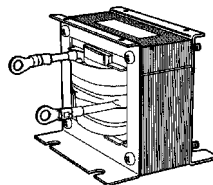

● Standard Models

| Inverter      |  | DC Reactor    |                   |                   |                 |
|---------------|--|---------------|-------------------|-------------------|-----------------|
| Voltage class | Maximum applicable motor capacity (kW) | 3G3IV-PUZDAB□ | Rated voltage (V) | Rated current (A) | Inductance (mH) |
| 200-V class   | 0.4/0.75                               | 5.4A8MH       | 800 VDC           | 5.4               | 8               |
|               | 1.5 to 3.7                             | 18A3MH        |                   | 18                | 3               |
|               | 5.5/7.5                                | 36A1MH        |                   | 36                | 1               |
|               | 11/15                                  | 72A0.5MH      |                   | 72                | 0.5             |
| 400-V class   | 0.4/0.75                               | 3.2A28MH      | 800 VDC           | 3.2               | 28              |
|               | 1.5/2.2                                | 5.7A11MH      |                   | 5.7               | 11              |
|               | 3.7                                    | 12A6.3MH      |                   | 12                | 6.3             |
|               | 5.5/7.5                                | 23A3.6MH      |                   | 23                | 3.6             |
|               | 11/15                                  | 33A1.9MH      |                   | 33                | 1.9             |

● External Dimensions (mm)

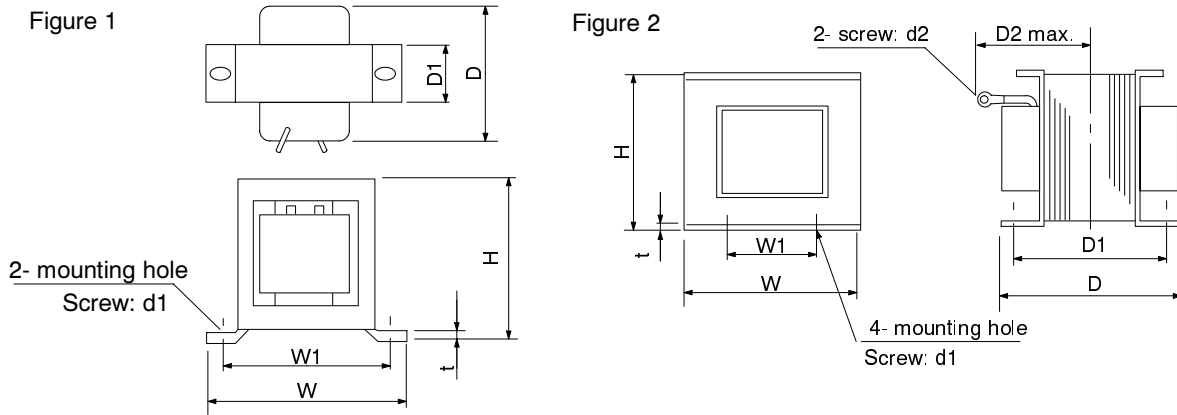

| 3G3HV-PUZDAB□ | Figure | Dimensions (mm) |     |    |     |     |     |     |    |     | Weight (kg) |
|---------------|--------|-----------------|-----|----|-----|-----|-----|-----|----|-----|-------------|
|               |        | H               | W   | W1 | D   | D1  | D2  | t   | d1 | d2  |             |
| 5.4A8MH       | 1      | 53              | 85  | 74 | 60  | 32  | --- | 0.8 | M4 | --- | 0.8         |
| 18A3MH        | 2      | 76              | 86  | 60 | 72  | 55  | 80  | 1.2 | M4 | M5  | 2.0         |
| 36A1MH        | 2      | 93              | 105 | 64 | 92  | 80  | 90  | 1.6 | M6 | M6  | 3.2         |
| 72A0.5MH      | 2      | 93              | 105 | 64 | 112 | 100 | 105 | 1.6 | M6 | M8  | 4.9         |
| 3.2A28MH      | 1      | 53              | 85  | 74 | 60  | 32  | --- | 0.8 | M4 | --- | 0.8         |
| 5.7A11MH      | 1      | 60              | 90  | 80 | 60  | 32  | --- | 0.8 | M4 | --- | 1.0         |
| 12A6.3MH      | 2      | 76              | 86  | 60 | 72  | 55  | 80  | 1.2 | M4 | M5  | 2.0         |
| 23A3.6MH      | 2      | 93              | 105 | 64 | 92  | 80  | 90  | 1.6 | M6 | M5  | 3.2         |
| 33A1.9MH      | 2      | 93              | 105 | 64 | 102 | 90  | 95  | 1.6 | M6 | M6  | 4.0         |

■ Separately Mounted Options

● AC Reactor (Yaskawa Electric)

3G3IV-PUZBAB□A□MH

Connect this AC Reactor for controlling harmonic current generated by the Inverter, or when the power supply capacity is extremely large compared with that of the Inverter. It is also effective for improving the power factor. Select an AC Reactor from the following tables according to the motor capacity.

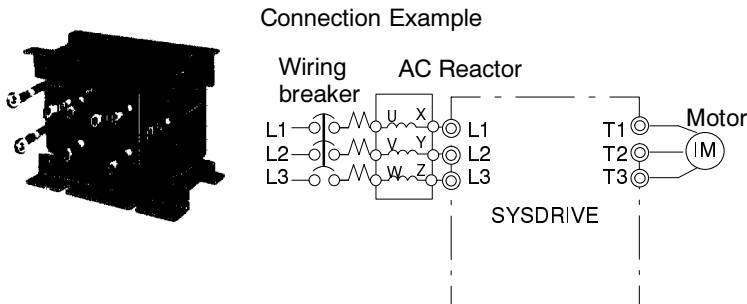

Applicable Range

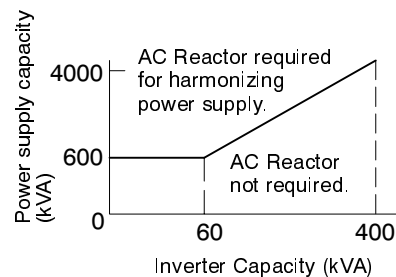



- Standard Specifications and Dimensions (mm)
- 200-V Class

| Maximum applicable motor capacity (kW) | 3G3IV-PUZBAB□ | Current (A) | Inductance (mH) | Loss (W) | Weight (kg) | Figure |
|--|---------------|-------------|-----------------|----------|-------------|--------|
| 0.4                                    | 2.5A4.2MH     | 2.5         | 4.2             | 15       | 2.5         | 1      |
| 0.75                                   | 5A2.1MH       | 5           | 2.1             | 15       | 2.5         |        |
| 1.5                                    | 10A1.1MH      | 10          | 1.1             | 25       | 3           |        |
| 2.2                                    | 15A0.71MH     | 15          | 0.71            | 30       | 3           |        |
| 3.7                                    | 20A0.53MH     | 20          | 0.53            | 35       | 3           | 2      |
| 5.5                                    | 30A0.35MH     | 30          | 0.35            | 45       | 3           |        |
| 7.5                                    | 40A0.265MH    | 40          | 0.265           | 50       | 4           |        |
| 11                                     | 60A0.18MH     | 60          | 0.18            | 65       | 6           |        |
| 15                                     | 80A0.13MH     | 80          | 0.13            | 75       | 8           |        |
| 18.5                                   | 90A0.12MH     | 90          | 0.12            | 90       | 8           |        |
| 22                                     | 120A0.09MH    | 120         | 0.09            | 90       | 8           |        |
| 30                                     | 160A0.07MH    | 160         | 0.07            | 100      | 12          |        |
| 37                                     | 200A0.05MH    | 200         | 0.05            | 110      | 15          |        |
| 45                                     | 240A0.044MH   | 240         | 0.044           | 125      | 23          |        |
| 55                                     | 280A0.038MH   | 280         | 0.038           | 130      | 23          |        |

| Dimensions (mm) |     |       |       |     |     |     |    |    |      |    |     |
|-----------------|-----|-------|-------|-----|-----|-----|----|----|------|----|-----|
| A               | B   | B1    | C     | D   | E   | F   | H  | J  | K    | L  | M   |
| 120             | 71  | ---   | 120   | 40  | 50  | 105 | 20 | M6 | 10.5 | 7  | M4  |
| 1120            | 71  | ---   | 120   | 40  | 50  | 105 | 20 | M6 | 10.5 | 7  | M4  |
| 130             | 88  | ---   | 130   | 50  | 65  | 130 | 22 | M6 | 11.5 | 7  | M4  |
| 130             | 88  | ---   | 130   | 50  | 65  | 130 | 22 | M6 | 11.5 | 7  | M4  |
| 130             | 88  | 114   | 105   | 50  | 65  | 130 | 22 | M6 | 11.5 | 7  | M5  |
| 130             | 88  | 119   | 105   | 50  | 70  | 130 | 22 | M6 | 9    | 7  | M5  |
| 130             | 98  | 139   | 105   | 50  | 75  | 130 | 22 | M6 | 11.5 | 7  | M6  |
| 160             | 105 | 147.5 | 130   | 75  | 85  | 160 | 25 | M6 | 10   | 7  | M6  |
| 180             | 100 | 155   | 150   | 75  | 80  | 180 | 25 | M6 | 10   | 7  | M8  |
| 180             | 100 | 150   | 150   | 75  | 80  | 180 | 25 | M6 | 10   | 7  | M8  |
| 180             | 100 | 155   | 150   | 75  | 80  | 180 | 25 | M6 | 10   | 7  | M10 |
| 210             | 100 | 170   | 175   | 75  | 80  | 205 | 25 | M6 | 10   | 7  | M10 |
| 210             | 115 | 182.8 | 175   | 75  | 95  | 205 | 25 | M6 | 10   | 7  | M10 |
| 240             | 126 | 218   | 215±5 | 150 | 110 | 240 | 25 | M6 | 8    | 7  | M10 |
| 240             | 126 | 218   | 215±5 | 150 | 110 | 240 | 25 | M8 | 8    | 10 | M12 |

• 400-V Class

| Maximum applicable motor capacity (kW) | 3G3IV-PUZBAB□ | Current (A) | Inductance (mH) | Loss (W) | Weight (kg) | Figure |
|--|---------------|-------------|-----------------|----------|-------------|--------|
| 0.4                                    | 1.3A18.0MH    | 1.3         | 18.0            | 15       | 2.5         | 1      |
| 0.75                                   | 2.5A8.4MH     | 2.5         | 8.4             | 15       | 2.5         |        |
| 1.5                                    | 5A4.2MH       | 5           | 4.2             | 25       | 3           |        |
| 2.2                                    | 7.5A3.6MH     | 7.5         | 3.6             | 35       | 3           |        |
| 3.7                                    | 10A2.2MH      | 10          | 2.2             | 43       | 3           |        |
| 5.5                                    | 15A1.42MH     | 15          | 1.42            | 50       | 4           |        |
| 7.5                                    | 20A1.06MH     | 20          | 1.06            | 50       | 5           | 2      |
| 11                                     | 30A0.7MH      | 30          | 0.7             | 65       | 6           |        |
| 15                                     | 40A0.53MH     | 40          | 0.53            | 90       | 8           |        |
| 18.5                                   | 50A0.42MH     | 50          | 0.42            | 90       | 8           |        |
| 22                                     | 60A0.36MH     | 60          | 0.36            | 90       | 8.5         |        |
| 30                                     | 80A0.26MH     | 80          | 0.26            | 95       | 12          |        |
| 37                                     | 90A0.24MH     | 90          | 0.24            | 110      | 15          |        |
| 45                                     | 120A0.18MH    | 120         | 0.18            | 130      | 23          |        |
| 55                                     | 150A0.15MH    | 150         | 0.15            | 150      | 23          |        |

| Dimensions (mm) |     |       |       |     |     |     |    |    |      |    |     |
|-----------------|-----|-------|-------|-----|-----|-----|----|----|------|----|-----|
| A               | B   | B1    | C     | D   | E   | F   | H  | J  | K    | L  | M   |
| 120             | 71  | ---   | 120   | 40  | 50  | 105 | 20 | M6 | 10.5 | 7  | M4  |
| 120             | 71  | ---   | 120   | 40  | 50  | 105 | 20 | M6 | 10.5 | 7  | M4  |
| 130             | 88  | ---   | 130   | 50  | 70  | 130 | 22 | M6 | 9    | 7  | M4  |
| 130             | 88  | ---   | 130   | 50  | 70  | 130 | 22 | M6 | 9    | 7  | M4  |
| 130             | 88  | ---   | 130   | 50  | 65  | 130 | 22 | M6 | 11.5 | 7  | M4  |
| 130             | 98  | ---   | 130   | 50  | 75  | 130 | 22 | M6 | 11.5 | 7  | M4  |
| 160             | 90  | 115   | 130   | 75  | 70  | 160 | 25 | M6 | 10   | 7  | M5  |
| 160             | 105 | 132.5 | 130   | 75  | 85  | 160 | 25 | M6 | 10   | 7  | M5  |
| 180             | 100 | 140   | 150   | 75  | 80  | 180 | 25 | M6 | 10   | 7  | M6  |
| 180             | 100 | 145   | 150   | 75  | 80  | 180 | 25 | M6 | 10   | 7  | M6  |
| 180             | 100 | 150   | 150   | 75  | 75  | 180 | 25 | M6 | 10   | 7  | M6  |
| 210             | 100 | 150   | 175   | 75  | 80  | 205 | 25 | M6 | 10   | 7  | M8  |
| 210             | 115 | 177.5 | 175   | 75  | 95  | 205 | 25 | M6 | 10   | 7  | M8  |
| 240             | 126 | 193   | 205±5 | 150 | 110 | 240 | 25 | M8 | 8    | 10 | M10 |
| 240             | 126 | 198   | 205±5 | 150 | 110 | 240 | 25 | M8 | 8    | 10 | M10 |

Figure 1

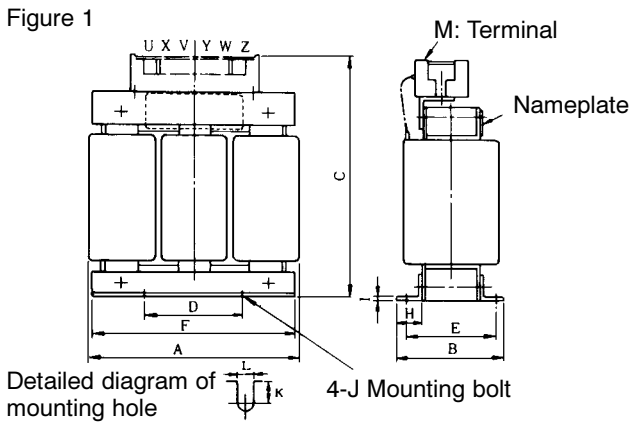
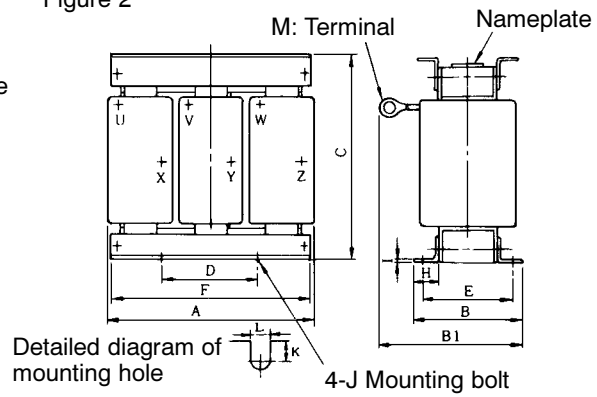

Figure 2



● Input Noise Filter (Soshin Electric)

3G3IV-PHF□

This Noise Filter prevents noise from entering the Inverter from power supply lines, and reduces the noise from the Inverter to the power supply lines. Connect it to the power supply input side.

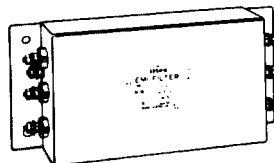

● Standard Models

| Maximum applicable motor capacity (kW) | 200-V class             |                    |                   | 400-V class             |                    |                   |
|--|-------------------------|--------------------|-------------------|-------------------------|--------------------|-------------------|
|  | Inverter capacity (kVA) | Input Noise Filter |                   | Inverter capacity (kVA) | Input Noise Filter |                   |
|  |                         | Model (3G3IV-)     | Rated current (A) |                         | Model (3G3IV-)     | Rated current (A) |
| 0.4                                    | 1.4                     | PHF3005AZ          | 5                 | 1.6                     | PHF3005CZ          | 5                 |
| 0.75                                   | 2.5                     | PHF3010AZ          | 10                | 2.8                     | PHF3005CZ          | 5                 |
| 1.5                                    | 3.3                     | PHF3010AZ          | 10                | 4.0                     | PHF3010CZ          | 10                |
| 2.2                                    | 4.5                     | PHF3015AZ          | 15                | 5.0                     | PHF3010CZ          | 10                |
| 3.7                                    | 7.2                     | PHF3030AZ          | 30                | 6.4                     | PHF3015CZ          | 15                |
| 5.5                                    | 11                      | PHF3040AZ          | 40                | 12                      | PHF3020CZ          | 20                |
| 7.5                                    | 14                      | PHF3050AZ          | 50                | 15                      | PHF3030CZ          | 30                |
| 11                                     | 21                      | PHF3080AZ          | 80                | 22                      | PHF3040CZ          | 40                |
| 15                                     | 26                      | PHF3100AZ          | 100               | 28                      | PHF3050CZ          | 50                |
| 18.5                                   | 32                      | PHF3150AZ          | 150               | 33                      | PHF3060CZ          | 60                |
| 22                                     | 40                      | PHF3150AZ          | 150               | 42                      | PHF3080CZ          | 80                |
| 30                                     | 53                      | PHF3200AZ          | 200               | 53                      | PHF3150CZ          | 150               |
| 37                                     | 65                      | PHF3240AZ          | 240               | 64                      | PHF3150CZ          | 150               |
| 45                                     | 75                      | PHF3240AZ          | 240               | 76                      | PHF3150CZ          | 150               |
| 55                                     | 91                      | PHF3150AZ x 2P     | 300               | 102                     | PHF3200CZ          | 200               |
| 75                                     | 120                     | PHF3200AZ x 2P     | 400               | 140                     | PHF3150CZ x 2P     | 300               |
| 110                                    | ---                     | ---                | ---               | 180                     | PHF3150CZ x 2P     | 300               |
| 160                                    | ---                     | ---                | ---               | 240                     | PHF3200CZ x 2P     | 400               |
| 185                                    | ---                     | ---                | ---               | 280                     | PHF3150CZ x 3P     | 450               |
| 220                                    | ---                     | ---                | ---               | 360                     | PHF3200CZ x 3P     | 600               |
| 300                                    | ---                     | ---                | ---               | 490                     | PHF3200CZ x 4P     | 800               |

● External Dimensions (mm)

| Model (3G3IV-) | Figure | A   | B   | C   | D   | E   | F   | G  | H   |     |       |     |     |     |     |     |    |
|----------------|--------|-----|-----|-----|-----|-----|-----|----|-----|-----|-------|-----|-----|-----|-----|-----|----|
| PHF3005AZ      | 1      | 220 | 208 | 195 | 170 | 95  | 70  | 50 | 50  |     |       |     |     |     |     |     |    |
| PHF3010AZ      |        |     |     |     |     |     |     |    |     |     |       |     |     |     |     |     |    |
| PHF3015AZ      |        |     |     |     |     |     |     |    |     |     |       |     |     |     |     |     |    |
| PHF3030AZ      |        |     |     |     |     |     |     |    |     |     |       |     |     |     |     |     |    |
| PHF3040AZ      | 2      | 355 | 330 | 320 | 285 | 120 | 90  | 70 | 80  |     |       |     |     |     |     |     |    |
| PHF3050AZ      |        |     | 340 |     |     |     |     |    |     |     |       |     |     |     |     |     |    |
| PHF3080AZ      |        |     | 420 |     |     |     |     |    |     | 410 | 380   | 340 | 160 | 130 | 90  | 100 |    |
| PHF3100AZ      | 3      | 300 | 260 | 240 | 220 | 420 | 105 | 97 | 105 |     |       |     |     |     |     |     |    |
| PHF3150AZ      |        |     | 270 |     |     |     |     |    |     | 250 | 230   | 450 | 118 | 99  | 110 |     |    |
| PHF3200AZ      |        |     | 290 |     |     |     |     |    |     | 270 | 250   | 480 | 115 | 115 |     |     |    |
| PHF3005CZ      | 1      | 220 | 208 | 195 | 170 | 95  | 70  | 50 | 50  |     |       |     |     |     |     |     |    |
| PHF3010CZ      |        |     |     |     |     |     |     |    |     | 274 | 248.5 | 230 | 210 | 110 | 80  | 60  | 70 |
| PHF3015CZ      |        |     |     |     |     |     |     |    |     |     |       |     |     |     |     |     |    |
| PHF3020CZ      |        |     |     |     |     |     |     |    |     |     |       |     |     |     |     |     |    |
| PHF3030CZ      | 2      | 355 | 330 | 320 | 285 | 120 | 90  | 70 | 80  |     |       |     |     |     |     |     |    |
| PHF3040CZ      |        |     |     |     |     |     |     |    |     |     |       |     |     |     |     |     |    |
| PHF3050CZ      |        |     | 340 |     |     |     |     |    |     |     |       |     |     |     |     |     |    |
| PHF3060CZ      |        |     | 420 |     |     |     |     |    |     | 394 | 380   | 340 | 160 | 130 | 90  | 100 |    |
| PHF3080CZ      |        |     |     |     |     |     |     |    |     | 410 |       |     |     |     |     |     |    |
| PHF3150CZ      | 3      | 325 | 270 | 250 | 230 | 450 | 118 | 99 | 110 |     |       |     |     |     |     |     |    |
| PHF3200CZ      |        |     |     |     |     |     |     |    |     | 345 | 290   | 270 | 250 | 480 | 115 | 115 |    |

| Model (3G3IV-) | J  | K   | L                  | M        | N        | P   | Q   | Weight (kg) |
|----------------|----|-----|--------------------|----------|----------|-----|-----|-------------|
| PHF3005AZ      | 25 | 10  | R 2.25<br>Length 6 | 4.5 dia. | M4       | M4  | --- | 1.0         |
| PHF3010AZ      |    |     |                    |          |          |     |     | 1.2         |
| PHF3015AZ      |    |     |                    |          |          |     |     | 1.3         |
| PHF3030AZ      | 35 | 12  | R 2.75<br>Length 7 | 5.5 dia. | M5       | M4  | --- | 2.4         |
| PHF3040AZ      | 40 | 12  | R 3.25<br>Length 8 | 6.5 dia. | M5       | M4  | 30  | 4.8         |
| PHF3050AZ      |    |     |                    |          | M6       |     |     | 5.6         |
| PHF3080AZ      | 50 | 15  |                    |          | M8       | M6  | 50  | 11          |
| PHF3100AZ      | 25 | 100 | 55                 | 20       | 6.5 dia. | M10 | M6  | 18.5        |
| PHF3150AZ      |    | 120 | 60                 |          |          |     |     | 27.5        |
| PHF3200AZ      |    | 150 | 75                 |          |          |     |     | 35          |
| PHF3005CZ      | 25 | 10  | R 2.25<br>Length 6 | 4.5 dia. | M4       | M4  | --- | 1.2         |
| PHF3010CZ      | 35 | 12  | R 2.75<br>Length 7 | 5.5 dia. | M4       | M4  | --- | 1.8         |
| PHF3015CZ      |    |     |                    |          |          |     |     | 2.0         |
| PHF3020CZ      |    |     |                    |          |          |     |     | 2.0         |
| PHF3030CZ      | 40 | 12  | R 3.25<br>Length 8 | 6.5 dia. | M5       | M4  | 30  | 3.1         |
| PHF3040CZ      |    |     |                    |          | M6       |     |     | 4.8         |
| PHF3050CZ      |    |     |                    |          | M6       |     |     | 5.6         |
| PHF3060CZ      | 50 | 15  | R 3.25<br>Length 8 | 6.5 dia. | M6       | M4  | 50  | 10          |
| PHF3080CZ      |    |     |                    |          | M8       |     |     | M6          |
| PHF3150CZ      | 25 | 120 | 60                 | 20       | 6.5 dia. | M12 | M6  | 27.5        |
| PHF3200CZ      |    | 150 | 75                 |          |          |     |     |             |

Figure 1

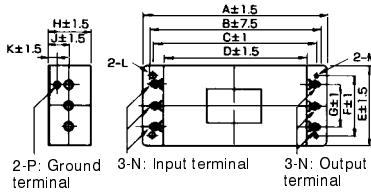

Figure 2

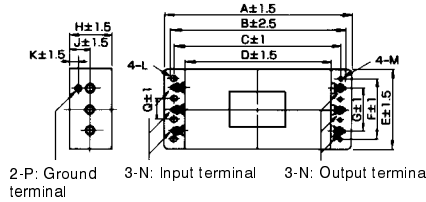
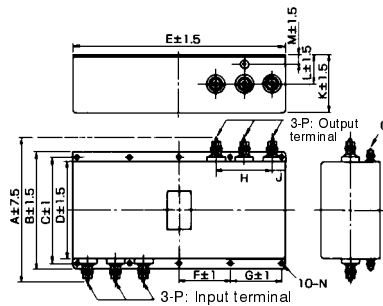

Figure 3



● Output Noise Filter (Tokin Corp.)

3G3IV-PLF□

This Noise Filter controls the noise generated by the Inverter from disseminating to the power supply side. Connect it to the motor output.

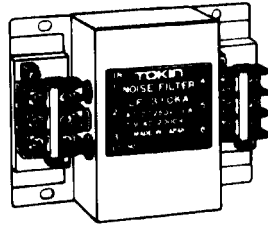

● Standard Models

| Maximum applicable motor capacity (kW) | 200-V class             |                     |                   | 400-V class             |                     |                   |
|--|-------------------------|---------------------|-------------------|-------------------------|---------------------|-------------------|
|  | Inverter capacity (kVA) | Output Noise Filter |                   | Inverter capacity (kVA) | Output Noise Filter |                   |
|  |                         | Model (3G3IV-)      | Rated current (A) |                         | Model (3G3IV-)      | Rated current (A) |
| 0.4                                    | 1.2                     | PLF310KA            | 10                | 1.4                     | PLF310KB            | 10                |
| 0.75                                   | 2.3                     | PLF310KA            | 10                | 2.6                     | PLF310KB            | 10                |
| 1.5                                    | 3.0                     | PLF310KA            | 10                | 3.7                     | PLF310KB            | 10                |
| 2.2                                    | 4.2                     | PLF310KA            | 10                | 4.7                     | PLF310KB            | 10                |
| 3.7                                    | 6.7                     | PLF320KA            | 20                | 6.1                     | PLF310KB            | 10                |
| 5.5                                    | 9.5                     | PLF350KA            | 50                | 11                      | PLF320KB            | 20                |
| 7.5                                    | 13                      | PLF350KA            | 50                | 14                      | PLF320KB            | 20                |
| 11                                     | 19                      | PLF350KA x 2P       | 100               | 21                      | PLF335KB            | 35                |
| 15                                     | 24                      | PLF350KA x 2P       | 100               | 26                      | PLF335KB            | 35                |
| 18.5                                   | 30                      | PLF350KA x 2P       | 100               | 31                      | PLF345KB            | 45                |
| 22                                     | 37                      | PLF350KA x 3P       | 150               | 40                      | PLF375KB            | 75                |
| 30                                     | 50                      | PLF350KA x 3P       | 150               | 50                      | PLF375KB            | 75                |
| 37                                     | 61                      | PLF3110KB x 2P      | 220               | 61                      | PLF3110KB           | 110               |
| 45                                     | 70                      | PLF3110KB x 2P      | 220               | 73                      | PLF3110KB           | 110               |
| 55                                     | 85                      | PLF3110KB x 3P      | 330               | 98                      | PLF375KB x 2P       | 150               |
| 75                                     | 110                     | PLF3110KB x 4P      | 440               | 130                     | PLF3110KB x 2P      | 220               |
| 110                                    | ---                     | ---                 | ---               | 170                     | PLF3110KB x 3P      | 330               |
| 160                                    | ---                     | ---                 | ---               | 230                     | PLF3110KB x 4P      | 440               |
| 185                                    | ---                     | ---                 | ---               | 260                     | PLF3110KB x 4P      | 440               |
| 220                                    | ---                     | ---                 | ---               | 340                     | PLF3110KB x 5P      | 550               |
| 300                                    | ---                     | ---                 | ---               | 460                     | PLF3110KB x 6P      | 660               |

● External Dimensions (mm)

| Model (3G3IV-) | Terminal      | A   | B   | C   | D   | E   | F   | G            | H        | Weight (kg) |
|----------------|---------------|-----|-----|-----|-----|-----|-----|--------------|----------|-------------|
| PLF310KA       | TE-K5.5<br>M4 | 140 | 100 | 100 | 90  | 70  | 45  | 7 x 4.5 dia. | 4.5 dia. | 0.5         |
| PLF320KA       | TE-K5.5<br>M4 | 140 | 100 | 100 | 90  | 70  | 45  | 7 x 4.5 dia. | 4.5 dia. | 0.6         |
| PLF350KA       | TE-K22<br>M6  | 260 | 180 | 180 | 160 | 120 | 65  | 7 x 4.5 dia. | 4.5 dia. | 2.0         |
| PLF310KB       | TE-K5.5<br>M4 | 140 | 100 | 100 | 90  | 70  | 45  | 7 x 4.5 dia. | 4.5 dia. | 0.5         |
| PLF320KB       | TE-K5.5<br>M4 | 140 | 100 | 100 | 90  | 70  | 45  | 7 x 4.5 dia. | 4.5 dia. | 0.6         |
| PLF335KB       | TE-K5.5<br>M4 | 140 | 100 | 100 | 90  | 70  | 45  | 7 x 4.5 dia. | 4.5 dia. | 0.8         |
| PLF345KB       | TE-K22<br>M6  | 260 | 180 | 180 | 160 | 120 | 65  | 7 x 4.5 dia. | 4.5 dia. | 2.0         |
| PLF375KB       | TE-K22<br>M6  | 540 | 320 | 480 | 300 | 340 | 240 | 9 x 6.5 dia. | 6.5 dia. | 12.0        |
| PLF3110KB      | TE-K60<br>M8  | 540 | 340 | 480 | 300 | 340 | 240 | 9 x 6.5 dia. | 6.5 dia. | 19.5        |

Dimensions

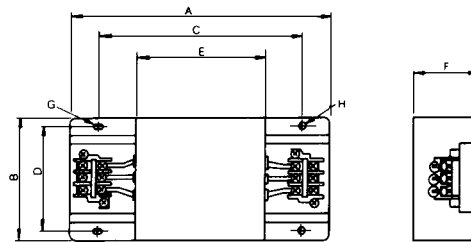

● Noise Filter Connection Example

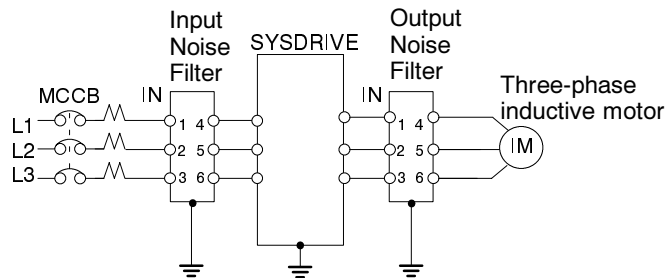



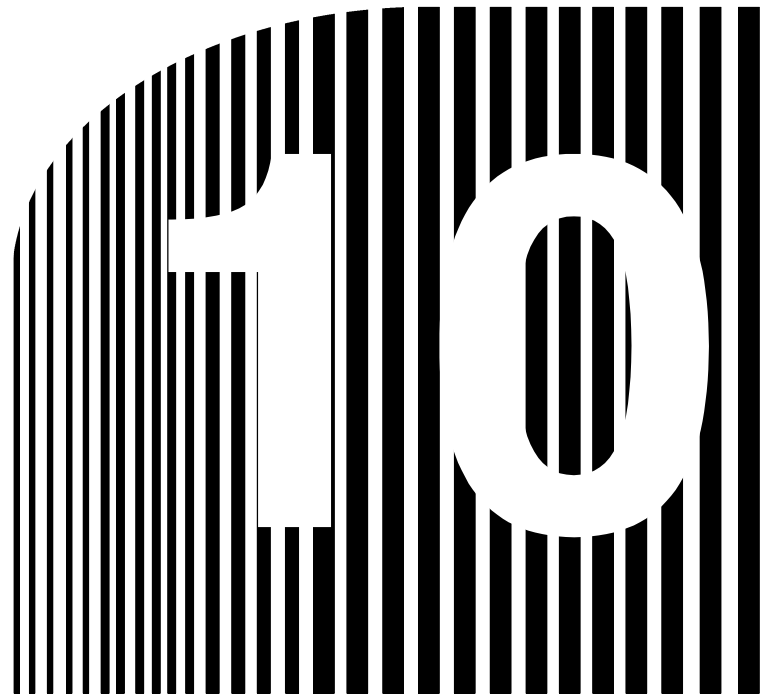

## Chapter 10

### • Appendix •

10-1 Notes on Using the Inverter for a Motor

10-2 List of Standard Models

## 10-1 Notes on Using the Inverter for a Motor

### ■ Using the Inverter for an Existing Standard Motor

When a standard motor is operated with the Inverter, power loss is slightly higher than when operated with a commercial power supply.

In addition, cooling effects also diminish in the low-speed range, resulting in an increase in the motor temperature. Therefore, the motor torque should be reduced in the low speed range.

The following graph shows the allowable load characteristics of a standard motor.

If 100% torque is continuously required in the low-speed range, use a special motor for use with inverters.

### Allowable Load Characteristics of Standard Motor

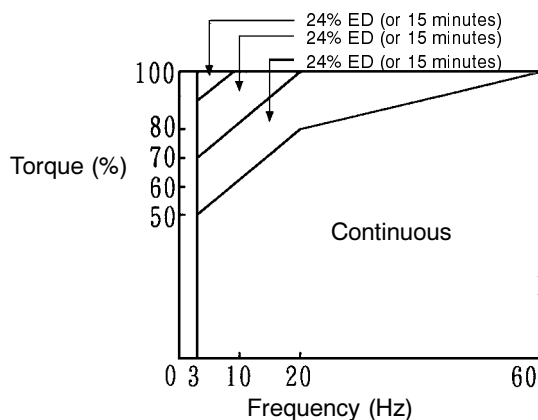

#### ● High-speed Operation

When using the motor at a high speed (60 Hz or more), problems may arise in dynamic balance and bearing durability.

#### ● Torque Characteristics

The motor may require more acceleration torque when the motor is operated with the Inverter than when operated with a commercial power supply. Check the load torque characteristics of the machine to be used with the motor to set a proper V/f pattern

#### ● Vibration

The 3G3FV Series uses a high carrier PWM to reduce motor vibration. When the motor is operated with the Inverter, motor vibration is almost the same as when operated with a commercial power supply. Motor vibration may, however, become greater in the following cases.

##### • Resonance with the natural frequency of the mechanical system

Take special care when a machine that has been operated at a constant speed is to be operated in variable speed mode.

If resonance occurs, install vibration-proof rubber on the motor base or use the frequency jump function to skip any frequency resonating the machine.

##### • Imbalanced rotor

Take special care when the motor is operated at a higher speed (60 Hz or more).

- **Noise**

Noise is almost the same as when the motor is operated with a commercial power supply. Motor noise, however, becomes louder when the motor is operated at a speed higher than the rated speed (60 Hz).

- **Using the Inverter for Special Motors**

- **Pole-changing Motor**

The rated input current of pole-changing motors differs from that of standard motors. Select, therefore, an appropriate Inverter according to the maximum input current of the motor to be used.

Before changing the number of poles, always make sure that the motor has stopped. Otherwise, the overvoltage protective or overcurrent protective mechanism will be actuated, resulting in an error.

- **Submersible Motor**

The rated input current of submersible motors is higher than that of standard motors. Therefore, always select an Inverter by checking its rated output current.

When the distance between the motor and Inverter is long, use a cable thick enough to connect the motor and Inverter to prevent motor torque reduction.

- **Explosion-proof Motor**

When an explosion-proof motor or increased safety-type motor is to be used, it must be subject to an explosion-proof test in conjunction with the Inverter. This is also applicable when an existing explosion-proof motor is to be operated with the Inverter.

Since the Inverter itself is, however, not explosion-proof, always install it in a safe place.

- **Gearmotor**

The speed range for continuous operation differs according to the lubrication method and motor manufacturer. In particular, continuous operation of an oil-lubricated motor in the low speed range may result in burning. If the motor is to be operated at a speed higher than 60 Hz, consult with the manufacturer.

- **Synchronous Motor**

A synchronous motor is not suitable for Inverter control.

If a group of synchronous motors is individually turned ON and OFF, synchronism may be lost.

- **Single-phase Motor**

Do not use an Inverter for a single-phase motor. The motor should be replaced with a 3-phase motor.

- **Power Transmission Mechanism (Speed Reducers, Belts, and Chains)**

If an oil-lubricated gearbox or speed reducer is used in the power transmission mechanism, oil lubrication will be affected when the motor operates only in the low speed range. The power transmission mechanism will make noise and experience problems with service life and durability if the motor is operated at a speed higher than 60 Hz.

**■ Motor Burnout Due to Insufficient Dielectric Strength of Each Phase of the Motor**

Surge occurs among the phases of the motor when the output voltage is switched. If the dielectric strength of each phase of the motor is insufficient, the motor may burn out. The dielectric strength of each phase of the motor must be higher than the maximum surge voltage. Normally, the maximum surge voltage is approximately three times the power voltage imposed on the Inverter.

Be sure to connect a dedicated motor to the 400-V Inverter. A standard motor may burn out if it is connected to the Inverter due to the insufficient dielectric strength of each phase of the standard motor.

**10-2 List of Standard Models**

| Voltage class            | Protective structure | Maximum applied motor capacity | Model         |
|--------------------------|----------------------|--------------------------------|---------------|
| 200-V class<br>(3-phase) | NEMA1 type           | 0.4 kW                         | 3G3FV-A2004   |
|                          |                      | 0.75 kW                        | 3G3FV-A2007   |
|                          |                      | 1.5 kW                         | 3G3FV-A2015   |
|                          |                      | 2.2 kW                         | 3G3FV-A2022   |
|                          |                      | 3.7 kW                         | 3G3FV-A2037   |
|                          |                      | 5.5 kW                         | 3G3FV-A2055   |
|                          |                      | 7.5 kW                         | 3G3FV-A2075   |
|                          |                      | 11 kW                          | 3G3FV-A2110   |
|                          |                      | 15 kW                          | 3G3FV-A2150   |
|                          | Open chassis type    | 18.5 kW                        | 3G3FV-B2185   |
|                          |                      | 22 kW                          | 3G3FV-B2220   |
|                          |                      | 30 kW                          | 3G3FV-B2300   |
|                          |                      | 37 kW                          | 3G3FV-B2370   |
|                          |                      | 45 kW                          | 3G3FV-B2450   |
|                          |                      | 55 kW                          | 3G3FV-B2550   |
|                          |                      | 75 kW                          | 3G3FV-B2750-E |
|                          |                      |                                |               |
| 400-V class<br>(3-phase) | NEMA1 type           | 0.4 kW                         | 3G3FV-A4004   |
|                          |                      | 0.75 kW                        | 3G3FV-A4007   |
|                          |                      | 1.5 kW                         | 3G3FV-A4015   |
|                          |                      | 2.2 kW                         | 3G3FV-A4022   |
|                          |                      | 3.7 kW                         | 3G3FV-A4037   |
|                          |                      | 5.5 kW                         | 3G3FV-A4055   |
|                          |                      | 7.5 kW                         | 3G3FV-A4075   |
|                          |                      | 11 kW                          | 3G3FV-A4110   |
|                          |                      | 15 kW                          | 3G3FV-A4150   |
|                          | Open chassis type    | 18.5 kW                        | 3G3FV-B4185   |
|                          |                      | 22 kW                          | 3G3FV-B4220   |
|                          |                      | 30 kW                          | 3G3FV-B4300   |
|                          |                      | 37 kW                          | 3G3FV-B4370   |
|                          |                      | 45 kW                          | 3G3FV-B4450   |
|                          |                      | 55 kW                          | 3G3FV-B4550   |
|                          |                      | 75 kW                          | 3G3FV-B4750-E |
|                          |                      | 110 kW                         | 3G3FV-B411K-E |
|                          |                      | 160 kW                         | 3G3FV-B416K-E |
|                          |                      | 185 kW                         | 3G3FV-B418K-E |
|                          |                      | 220 kW                         | 3G3FV-B422K-E |
| 300 kW                   | 3G3FV-B430K-E        |                                |               |

# Index

## A

AC Reactor, 2-27  
3G3IV-PUZBAB\_A\_MH, specifications, 9-19

acceleration, 5-11, 5-12, 5-17  
time settings, 5-11  
time switching frequency, 5-12  
times, 5-17

acceleration/deceleration ramp hold, 6-61

access levels, 1-7, 3-5, 3-18, 5-2

Advanced, 1-7  
parameter setting, 3-9

AFR. *See* automatic frequency generator

analog input characteristics, with gain and bias, 6-74

analog inputs, 5-6  
adjusting, gain and bias, 5-7, 6-22  
switching, 5-6

Analog Monitor Card, settings, 6-56

Analog Operator  
3G3IV-PJVOP95\_, specifications, 9-12  
3G3IV-PJVOP96\_, specifications, 9-11

Analog Reference Card, settings, 6-55

ASR. *See* speed loop

ASR gain switch, 6-69

ASR integral reset, 6-62

ASR selection, 6-62

automatic frequency regulator, 6-5

auto-tuning, 1-4, 3-28, 4-8  
input voltage setting, flux vector control, 5-33  
open-loop vector control, 5-19  
faults, 5-20  
parameter settings, 5-19

## B

base frequency, maximum, 4-10

Basic, 1-7  
parameter setting, 3-8

bias, analog inputs, 5-7

Braking Resistor, 2-35  
3G3IV-PERF150WJ\_, specifications, 9-17

Braking Resistor Unit  
3G3IV-PLKBE\_, specifications, 9-14  
connecting, 2-35

Braking Unit  
3G3IV-PCDBR\_, specifications, 9-13  
connecting, 2-35  
parallel, 2-36

## C

cables, length, 2-30

capacitors, harmonics, 2-32

carrier frequency, 6-50

cautions  
installation, 2-8  
operation, 4-2  
wiring, 2-10, 8-18

connection diagram, 3.7- to 15-kW output, 2-17

control circuit  
terminals, 2-16  
wiring, 2-45

control inputs, 5-10  
responsiveness, 5-10

control modes, 3-19, 5-3

current, rated setting  
V/f control, 5-22  
V/f control with PG, 5-41

## D

DC injection activate, 6-68

DC injection braking function, 6-36

DC Reactor, 3G3HV-PUDZAB\_A\_MH, specifications, 9-18

deceleration, 5-11, 5-12, 5-17  
time settings, 5-11  
time switching frequency, 5-12  
times, 5-17

Digital Operator, 1-6, 1-10, 4-11  
attaching, 2-12  
removing, 2-11

Digital Operator Connecting Cable, 3G3FV-PCN\_25, specifications, 9-18

Digital Reference Card, settings, 6-55

dimensions, 2-2

display, status, 4-5

droop control, 6-14

dwell, 1-6

# Index

---

## E

- electromagnetic switch, 2-28
- emergency stop, 5-18
  - time setting, 5-11
- encoder pulses, selecting number of, 2-46
- energy-saving control function, 6-10, 6-32
- errors, operation, 8-9
- excitation, 6-72
- external baseblock N.C., 6-60
- external baseblock N.O., 6-60
- external faults, 6-66
- external search 1, 6-68
- external search 2, 6-68

## F

- fast-stop, 5-12, 5-18
- fault reset, 6-64
- fault restart settings, 6-87
- faults, 8-2
  - auto-tuning
    - flux vector control, 5-34
    - open-loop vector control, 5-20
  - detecting methods
    - flux vector control, 5-30
    - V/f control with PG, 5-44
  - minor, 8-7
  - overspeed
    - flux vector control, 5-30
    - V/f control with PG, 5-44
- feedback control, 1-5
- filter time constant, 5-8
- flux vector control, 1-4, 5-28, 6-13
  - PG Speed Control Cards, 5-28
- frequency detection settings, 6-84
- frequency references, 1-5, 5-4, 5-16, 6-52
  - jog, 5-16
  - main-speed, 5-18
  - multi-step, 5-16
  - presetting, 5-9
  - selecting, 5-4
  - selecting the source, 5-8
  - selecting the units, 5-9
  - terminal 13 voltage input, 5-5
  - terminal 14 current input, 5-5
  - terminal 16 voltage input, 5-6
  - voltage range, 5-5
- front cover
  - mounting, 2-12
  - removing, 2-11
    - for Inverter with 18.5-kW output or more, 2-12

## G–H

- gain, analog inputs, 5-7
- gear teeth, 5-43
- ground, wiring, 2-31
- ground fault interrupter, 2-26
- hardware protection settings, 6-89
- harmonics, 2-32
  - capacitors, 2-32
  - countermeasures, 2-33
  - Inverter, 2-33
  - rectifiers, 2-32
- hold status, 6-53
- hunting-prevention function, 6-11, 6-33

## I

- IGBT, 1-6
- induction noise, countermeasures, 2-29
- initial excitation function, flux vector control, 5-32
- initialize mode, 3-18
  - parameter list, 7-3
- Input Noise Filter, 3G3IV-PHF\_, specifications, 9-22
- input voltage, setting, 4-6
  - V/f control, 5-22
  - V/f control with PG, 5-41
- inspection, 8-18
- installation, 2-8
  - conditions, 2-9
    - NEMA1 Type, 2-9
    - Open Chassis Type, 2-9
  - orientation, 2-8
  - space, 2-8
- insulated gate bipolar transistor. *See* IGBT
- integral control, V/f control with PG, 5-43
- inverter operating 1, 6-72
- inverter operating 2, 6-72
- inverter overload, 6-51

## J–L

- jog, 5-10, 5-18
- jumper, 5-6
- jumping, 6-52
- key function settings, 6-91
- language, 3-18
- local/remote selection, 6-60

# Index

---

## M

- magnetic contactor, 2-26, 2-28
- main circuit
  - input side wiring, 2-26
  - output side wiring, 2-28
  - terminals
    - 200 V, 2-14
    - 400 V, 2-15
- maintenance, 8-19
- models, list, 1-3, 10-5
- modes
  - Inverter, 3-3
  - switching, 3-3
- modified constants mode, 3-30
- molded-case circuit breaker, 2-26
- momentary power loss settings, 6-78
- monitor output, adjusting, 6-76
- monitoring
  - operation mode
    - fault history, 3-15
    - fault trace, 3-14
    - status monitor, 3-12
  - startup, 3-15
- motor
  - selection
    - V/f control, 5-22
    - V/f control with PG, 5-41
    - using the Inverter for a special motor, 10-3
    - using the Inverter for a standard motor, 10-2
- motor constants, 6-6, 6-12, 6-34
  - V/f control, 5-22, 6-27
  - V/f control with PG, 5-41
- motor protection settings, 6-77
- motor rated FLA, 4-10
- multi-function analog input/frequency reference, current, 6-73
- multi-function analog output settings, 6-76
- multi-function analog output signal level, 6-77
- multi-function input settings, 6-58
- multi-function inputs, 5-14
- multi-function output settings, 6-70

## N

- NEMA1 Type, installation conditions, 2-9
- noise filter
  - output side, 2-29
  - LC/RC, 2-28
  - power supply side, 2-27

- no-load, operation, 4-10
  - Digital Operator, 4-11
  - frequency reference setting, 4-10
  - status checking, 4-11
- nomenclature, 1-8

## O

- OH prealarm, 6-72
- OH2 alarm signal, 6-62
- Open Chassis Type, installation conditions, 2-9
- open-loop vector control, 1-4, 5-19, 6-2
- operation mode, 3-10
- operator display selection, 6-90
- option/inverter selection, 6-60
- Optional Cards, settings, 6-54
- Output Noise Filter, 3G3IV-PLF\_, specifications, 9-26
- overload OL1, 6-72
- overspeed
  - flux vector control, 5-30
  - V/f control with PG, 5-44
- overtorque detection settings, 6-88

## P

- parameters
  - initializing, 3-20, 4-6
  - lists, 7-1
    - initialize mode, 7-3
    - program mode, 7-5
  - program mode, 3-25
  - setting
    - Advanced, 3-9
    - Basic, 3-8
    - program mode, 3-26
    - Quick-start, 3-7
- password, 3-21
- PG
  - disconnection stopping method
    - flux vector control, 5-30
    - V/f control with PG, 5-44
  - flux vector control, 5-28
  - gear teeth, V/f control with PG, 5-43
  - pulse number
    - flux vector control, 5-28
    - V/f control with PG, 5-43
  - pulse output monitor division ratio, flux vector control, 5-29
  - rotation direction, flux vector control, 5-28
  - speed deviation
    - flux vector control, 5-31
    - V/f control with PG, 5-45
  - V/f control with PG, 5-43



# Index

PG Speed Control Card, 5-28, 5-43  
installing, 2-38  
terminal blocks, 2-39  
wiring, 2-44  
wiring, 2-41

phase advance capacitor, 2-28

PID control function, 1-5, 6-39  
adjusting, 6-44  
block diagram, 6-41  
control operations, 6-40  
control settings, 6-42  
types, 6-40

PID disable, 6-64

poles, 5-41  
number, 5-41

position-lock. *See* zero-servo control

power supplies, 4-5  
input, connecting, 2-27

power transmission mechanism, 10-3

power-on monitor, 3-16

program lockout, 6-65

program mode, 3-25  
parameter groups, 3-25  
parameter list, 7-5

Pulse Monitor Card, settings, 6-57

## Q–R

Quick-start, 1-7  
parameter setting, 3-7

radio noise, countermeasures, 2-30

reactors  
harmonics, countermeasures, 2-33  
wiring, 2-34

rectifiers, harmonics, 2-32

reference hold function, 6-46

reference source, 5-4

reverse operation, 5-12

run, 5-10  
command, 5-10  
source, 5-10

## S

Scaling Meter, K3TJ-V11, specifications, 9-10

S-curve characteristic function, 6-47

sequence control, 3-wire, 5-15

sequential operation, 3-20

## settings

Acc/Dec SW Freq, C1-11, 5-12  
Acc/Dec Units, C1-10, 5-11  
Acceleration time 1, C1-01, 5-11  
Acceleration time 2, C1-03, 5-11  
Acceleration time 3, C1-05, 5-11  
Acceleration time 4, C1-07, 5-11  
Access Level, A1-01, 3-18, 5-2  
AFR Gain, C8-08, 6-5  
AI-14 Input Sel, F2-01, 6-55  
Analog output bias (terminal 21), H4-03, 5-38, 5-48  
Analog output bias (terminal 23), H4-06, 5-38, 5-48  
Analog output gain (terminal 21), H4-02, 5-38, 5-48  
Analog output gain (terminal 23), H4-05, 5-38, 5-48  
Analog output level selection, H4-07, 5-38, 5-48  
Analog output selection (terminal 21), H4-01, 5-38, 5-48  
Analog output selection (terminal 23), H4-04, 5-38, 5-48  
AO Ch1 Gain, F4-02, 6-56  
AO Ch1 Select, F4-01, 6-56  
AO Ch2 Gain, F4-04, 6-56  
AO Ch2 Select, F4-03, 6-56  
AO Level Select, H4-07, 6-77  
ASR Delay Time, C5-06, 5-38  
ASR Gain SW Freq, C5-07, 5-37  
ASR I Time 1, C5-02, 5-36, 5-46  
ASR I Time 2, C5-04, 5-36, 5-46  
ASR Limit, C5-05, 5-49  
ASR P Gain 1, C5-01, 5-36, 5-46  
ASR P Gain 2, C5-03, 5-36, 5-46  
Base Frequency, E1-06, 4-9, 5-27, 6-6, 6-27  
Carrier Freq Gain, C6-03, 6-51  
Carrier Freq Max, C6-01, 6-51  
Carrier Freq Min, C6-02, 6-51  
Cntl Input Scans, b1-06, 5-10  
Control Method, A1-02, 3-19, 5-3  
DB Resistor Prot, L8-01, 6-89  
DC Inj Current, b2-02, 6-36  
DC Inj Start Freq, b2-01, 6-36  
DC Inj Time@Start, b2-03, 6-36  
DC Inj Time@Stop, b2-04, 6-36  
Deceleration time 1, C1-02, 5-11  
Deceleration time 2, C1-04, 5-11  
Deceleration time 3, C1-06, 5-11  
Deceleration time 4, C1-08, 5-11  
Delay-OFF Timer, b4-02, 6-39  
Delay-ON Timer, b4-01, 6-39  
DI Input, F3-01, 6-55  
Display Scaling, o1-03, 5-9  
Display Units, o1-04, 6-27  
Droop delay time, b7-02, 6-14  
Droop gain, b7-01, 6-14  
Dwell Ref @Start, b6-01, 6-46  
Dwell Ref @Stop, b6-03, 6-46  
Dwell Time @Stop, b6-04, 6-46  
Dwell Time@Start, b6-02, 6-46  
Elapsed Time Run, o2-08, 6-92  
Elapsed Time Set, o2-07, 6-92  
Energy Save Freq, b8-02, 6-10, 6-32  
Energy Save Gain, b8-01, 6-10, 6-32  
Enter Password, A1-04, 3-22  
Excitation level, b2-01, 5-32  
Fast Stop Time, C1-09, 5-12  
Filter Avg Time, H3-12, 5-8  
Hung Prev Gain, C7-02, 6-11

# Index

---

Hung Prev Select, C7-01, 6-11  
Hunt Prev Gain, C7-02, 6-33  
Hunt Prev Select, C7-01, 6-33  
Init Parameters, A1-03, 3-20  
Initial excitation time when starting, b2-03, 5-32  
Initial excitation time when stopping, b2-04, 5-32  
Input Voltage, E1-01, 4-6, 5-19, 5-22, 5-33, 5-41  
Inverter Model #, o2-04, 6-92  
Jog Reference, d1-09, 5-10  
Jump Bandwidth, d3-04, 6-52  
Jump Freq 1, d3-01, 6-52  
Jump Freq 2, d3-02, 6-52  
Jump Freq 3, d3-03, 6-52  
Leak Inductance, E2-06, 6-8, 6-29  
Local/Remote Key, o2-01, 6-91  
Max Frequency, E1-04, 5-27, 6-6, 6-27  
Max Voltage, E1-05, 4-9, 5-27, 6-6, 6-27  
Mechanical Loss, E2-09, 6-29  
Mid Frequency A, E1-07, 5-27, 6-6  
Mid Voltage A, E1-08, 5-27, 6-6  
Min Frequency, E1-09, 5-27, 5-32, 6-6, 6-27  
Min Voltage, E1-10, 5-27, 6-6  
MOL Fault Select, L1-01, 6-77  
MOL Time Const, L1-02, 6-78  
MOP Ref Memory, d4-01, 6-53  
Motor Rated FLA, E2-01, 4-9, 5-22, 5-41, 6-7, 6-28  
Motor Rated Slip, E2-02, 6-7, 6-12, 6-28, 6-34  
Motor Selection, E1-02, 5-22, 5-41  
No-Load Current, E2-03, 6-7, 6-12, 6-28, 6-34  
Num of Restarts, L5-01, 6-87  
Number of Poles, E2-04, 5-41, 6-28  
OH Pre-Alarm Lvl, L8-02, 6-89  
OH Pre-Alarm Set, L8-03, 6-89  
Oper Detection, o2-06, 6-92  
Oper Stop Key, o2-02, 6-91  
Operator M.O.P., o2-05, 6-92  
PG # Gear Teeth1, F1-12, 5-43  
PG # Gear Teeth2, F1-13, 5-43  
PG Deviate Level, F1-10, 5-31, 5-46  
PG Deviate Time, F1-11, 5-31, 5-46  
PG Deviation Sel, F1-04, 5-31, 5-45  
PG Fdbk Loss Sel, F1-02, 5-30, 5-44  
PG Output Ratio, F1-06, 5-29  
PG Overspd Level, F1-08, 5-30, 5-45  
PG Overspd Time, F1-09, 5-30, 5-45  
PG Overspeed Sel, F1-03, 5-30, 5-44  
PG Pulses/Rev, F1-01, 5-28, 5-43  
PG Ramp PI/I Sel, F1-07, 5-44  
PG Rotation Sel, F1-05, 5-29  
Ph Loss In Sel, L8-05, 6-89  
Ph Loss Out Sel, L8-07, 6-90  
PID D Time, b5-05, 6-42  
PID Delay Time, b5-08, 6-43  
PID Gain, b5-02, 6-42  
PID I Limit, b5-04, 6-42  
PID I Time, b5-03, 6-42  
PID Limit, b5-06, 6-43  
PID Mode, b5-01, 6-42  
PID Offset, b5-07, 6-43  
PO-36F Selection, F7-01, 6-57  
Power-On Monitor, o1-02, 3-16, 6-90  
PUV Det Level, L2-05, 6-80  
PwrL Baseblock t, L2-03, 6-38, 6-79  
PwrL Ridethru t, L2-02, 6-79  
PwrL Selection, L2-01, 6-78  
PwrL V/F Ramp t, L2-04, 6-79  
Ref Hold Time, d5-06, 6-24  
Ref Loss Sel, L4-05, 6-85  
Ref Lower Limit, d2-02, 6-52  
Ref Upper Limit, d2-01, 6-52  
Reference 1, d1-01, 5-9  
Reference 2, d1-02, 5-9  
Reference 3, d1-03, 5-9  
Reference 4, d1-04, 5-9  
Reference 5, d1-05, 5-9  
Reference 6, d1-06, 5-9  
Reference 7, d1-07, 5-9  
Reference 8, d1-08, 5-9  
Reference Source, b1-01, 5-4, 5-8  
Restart Sel, L5-02, 6-87  
Reverse Oper, b1-04, 5-12  
Run Source, b1-02, 5-10  
Saturation Comp 1, E2-07, 6-8, 6-29  
Saturation Comp 2, E2-08, 6-8, 6-29  
SCrv Acc @ End, C2-02, 6-47  
SCrv Acc @ Start, C2-01, 6-47  
SCrv Dec @ End, C2-04, 6-47  
SCrv Dec @ Start, C2-03, 6-47  
Select Language, A1-00, 3-18  
Select Password, A1-05, 3-22  
Slip Come Gain, C3-01, 6-30, 6-48  
Slip Come Limit, C3-03, 6-49  
Slip Come Regen, C3-04, 6-49  
Slip Come Time, C3-02, 6-48  
Spd Agree Level, L4-01, 6-84  
Spd Agree Lvl+-, L4-03, 6-84  
Spd Agree Wdth+-, L4-04, 6-84  
Spd Agree Width, L4-02, 6-84  
Spd Srch at Start, b3-01, 6-37  
Spd Srch Current, b3-02, 6-38  
Spd Srch Dec Time, b3-03, 6-38  
Speed Limit Sel, d5-03, 6-18  
Speed Lmt Bias, d5-05, 6-20  
Speed Lmt Value, d5-04, 6-19  
StallP Accel Lvl, L3-02, 6-80  
StallP Accel Sel, L3-01, 6-80  
StallP CHP Lvl, L3-03, 6-81  
StallP Decel Sel, L3-04, 6-82  
StallP Run Level, L3-06, 6-83  
StallP Run Sel, L3-05, 6-83  
Stopping Method, b1-03, 5-13, 5-31  
Term 13 Signal, H3-01, 5-5, 6-19  
Term 14 Signal, H3-08, 5-5, 6-17, 6-21  
Term 16 Signal, H3-04, 5-6, 6-17, 6-21  
Term Resistance, E2-05, 6-8, 6-12, 6-29, 6-34  
Terminal 13 Bias, H3-03, 5-7, 6-22  
Terminal 13 Gain, H3-02, 5-7, 6-22  
Terminal 14 Bias, H3-11, 5-7, 6-22  
Terminal 14 Gain, H3-10, 5-7, 6-22  
Terminal 14 Sel, H3-09, 5-5, 6-4, 6-17, 6-21, 6-25, 6-73  
Terminal 16 Bias, H3-07, 5-7, 6-22  
Terminal 16 Gain, H3-06, 5-7, 6-22  
Terminal 16 Sel, H3-05, 5-6, 6-4, 6-17, 6-21, 6-25, 6-73  
Terminal 21 Bias, H4-03, 6-76  
Terminal 21 Gain, H4-02, 6-76  
Terminal 21 Sel, H4-01, 6-76  
Terminal 23 Bias, H4-06, 6-76

# Index

Terminal 23 Gain, H4-05, 6-76  
Terminal 23 Sel, H4-04, 6-76  
Terminal 25 Sel, H2-02, 6-71  
Terminal 26 Sel, H2-03, 6-71  
Terminal 3 Sel, H1-01, 5-14, 6-59  
Terminal 4 Sel, H1-02, 5-14, 6-59  
Terminal 5 Sel, H1-03, 5-14, 6-59  
Terminal 6 Sel, H1-04, 5-14, 6-59  
Terminal 7 Sel, H1-05, 5-14, 6-59  
Terminal 8 Sel, H1-06, 5-14, 6-59  
Terminal 9 Sel, H2-01, 6-71  
Torq Comp Gain, C4-01, 6-49  
Torq Comp Time, C4-02, 6-50  
Torq Control Sel, d5-01, 6-16, 6-23  
Torq Det 1 Lvl, L6-02, 6-88  
Torq Det 1 Sel, L6-01, 6-88  
Torq Det 1 Time, L6-03, 6-88  
Torq Det 2 Lvl, L6-05, 6-88  
Torq Det 2 Sel, L6-04, 6-88  
Torq Det 2 Time, L6-06, 6-88  
Torq Ref Filter, d5-02, 6-21  
Torque Limit Fwd, L7-01, 6-3, 6-25  
Torque Limit Fwd Rgn, L7-03, 6-3, 6-25  
Torque Limit Rev, L7-02, 6-3, 6-25  
Torque Limit Rev Rgn, L7-04, 6-3, 6-25  
Trim Control Lvl, d4-02, 6-54  
User Defaults, o2-03, 6-91  
User Monitor Sel, o1-01, 3-15, 6-90  
User parameter 1 to 32, A2-01 to A1-32, 3-22  
V/f Selection, E1-03, 5-23, 5-42  
Zero Servo Count, b9-02, 6-15  
Zero Servo Gain, b9-01, 6-15  
Zero Speed Oper, b1-05, 5-32

slip compensation gain, 6-29, 6-48

solderless terminals, round  
control circuit, 2-45  
main circuit, 2-25

## specifications

3G3FV-PCN\_25 Digital Operator Connecting Cable, 9-18  
3G3HV-PUZDAB\_A\_MH DC Reactor, Yaskawa Electric, 9-18  
3G3IV-PCDBR\_Braking Unit, Yaskawa Electric, 9-13  
3G3IV-PERF150WJ\_Braking Resistor, Yaskawa Electric, 9-17  
3G3IV-PHF\_Input Noise Filter, Soshin Electric, 9-22  
3G3IV-PJVOP95\_Analog Operator, 9-12  
3G3IV-PJVOP96\_Analog Operator, 9-11  
3G3IV-PLF\_Output Noise Filter, Tokin Corp., 9-26  
3G3IV-PLKBE\_Braking Resistor Unit, Yaskawa Electric, 9-14  
3G3IV-PUZBAB\_A\_MH AC Reactor, Yaskawa Electric, 9-19  
Inverters, 9-2  
K3TJ-V11 Scaling Meter, 9-10

## speed control loop

flux vector control, 5-38  
fine adjustments, 5-38  
V/f control with PG, 5-47

speed feedback, 6-5

speed limit function, 6-18

## speed loop

flux vector control, 5-36  
integral reset  
flux vector control, 5-37  
V/f control with PG, 5-47  
integral time  
flux vector control, 5-36  
low-speed in flux vector control, 5-36  
low-speed in V/f control with PG, 5-46  
V/f control with PG, 5-46  
mode select, V/f control with PG, 5-47  
proportional gain  
flux vector control, 5-36  
low-speed in flux vector control, 5-36  
low-speed in V/f control with PG, 5-46  
V/f control with PG, 5-46  
proportional gain switch, flux vector control, 5-37  
responsiveness, flux vector control, 5-38  
V/f control with PG, 5-46

speed search function, 6-37

speed torque control change, 6-69

stall prevention function settings, 6-80

## stopping method, 5-13

DC braking, 5-14  
deceleration, 5-13  
flux vector control, 5-31  
free-run, 5-13  
free-run stop with timer, 5-14

surge absorber, 2-27

switching, speed control and torque control, 6-23  
timer, 6-23

# T

temperature, 2-9

terminal 16 enable, 6-62

## terminals, 1-9

configuration, 2-13  
control circuit, 2-16  
main circuit  
200 V, 2-14  
400 V, 2-15

thermal relay, 2-29

timer function, 6-39

torque compensation function, 6-21, 6-49

torque control, 1-4, 6-16

torque limits, 6-3, 6-24  
analog inputs, 6-4, 6-25

torque reference, 6-17  
primary filter, 6-20

trim, 6-54

trim control increase and decrease, 6-65

troubleshooting, 8-11

# Index

---

## U–V

- units, 5-9
  - frequency reference, 5-9
- UP and DOWN commands, 6-62
- user constants, 3-22
- user monitor selection, 3-15
- V/f control, 5-22, 6-9
  - motor constants, 5-22, 6-27
- V/f control with PG, 5-41
  - feedback, 6-31
  - motor constants, 5-41
  - PG Speed Control Cards, 5-43
- V/f patterns, 1-5
  - custom, setting, 5-27
  - selecting
    - V/f control, 5-23
    - V/f control with PG, 5-42
  - setting, 4-9
  - user-defined, setting, 5-42
- vector control, 1-4
  - flux, 1-4
  - open-loop, 1-4
- ventilation, 2-9
- voltage, 4-6, 5-33
  - input, 4-6
    - auto-tuning in flux vector control, 5-33
  - maximum, 4-10

- voltage range, 5-5
- frequency reference, 5-5

## W

- warnings
  - installation, 2-8
  - operation, 4-2
  - wiring, 2-10, 8-18
- wires, sizes
  - control circuit, 2-37
  - main circuit, 2-22
- wiring
  - connection diagram, 3.7- to 15-kW output, 2-17
  - control circuit, 2-37
  - main circuit, 2-21
  - reactors, 2-34
- write-protect, 3-21

## Z

- zero-servo command, 6-69
- zero-servo control, 1-5, 6-15
- zero-servo end, 6-73
- zero-speed operation
  - flux vector control, 5-31
  - setting, flux vector control, 5-32

# Revision History

A manual revision code appears as a suffix to the catalog number on the front cover of the manual.

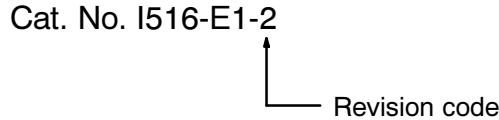

The following table outlines the changes made to the manual during each revision. Page numbers refer to the previous version.

| Revision code | Date           | Revised content  |
|---------------|----------------|--|
| 1             | September 1996 | Original production  |
| 2             | April 1997     | <p>The following constant numbers were added to Section 7: b1-07, C3-05, C5-08, C8-30, E1-11, E1-12, E1-13, F1-14, F8-01, H5-05</p> <p><b>Page 1-2:</b> Inverter model list updated. “3-phase” added.</p> <p><b>Page 1-5:</b> Low noise and harmonic countermeasure information clarified.</p> <p><b>Page 2-5:</b> Dimensions added for the new models.</p> <p><b>Pages 2-12, 2-13:</b> Terminals and connections changed for the 200-V Class and 400-V Class tables. Notes added. New models reflected.</p> <p><b>Pages 2-16, 2-17, 2-19, 2-20:</b> New models added.</p> <p><b>Page 2-21:</b> New wire sizes and tightening torque added.</p> <p><b>Page 2-23:</b> New models reflected in the information for wiring the power terminal of the Inverter.</p> <p><b>Pages 2-26, 2-29:</b> Note added.</p> <p><b>Page 2-31:</b> New models reflected in the bottom output diagram.</p> <p><b>Page 3-29:</b> Motor selection explanation corrected.</p> <p><b>Pages 5-19, 5-34:</b> Motor selection information corrected.</p> <p><b>Page 5-26:</b> New models reflected in the V/f patterns.</p> <p><b>Page 5-27:</b> Note 2 reference removed from E1-07 in the table. New models reflected in Note 3.</p> <p><b>Page 5-42:</b> New models reflected in Note 2.</p> <p><b>Page 6-50:</b> <i>Setting the Carrier Frequency and Inverter Overload “OL2”</i> information added.</p> <p><b>Pages 6-50, 6-51:</b> Note references added to the carrier frequency table. Following note rewritten.</p> <p><b>Page 6-58:</b> Setting 16 (Motor 2 Selection) added to the table.</p> <p><b>Page 6-70:</b> Settings 1C to 1E corrected and added to.</p> <p><b>Page 6-79:</b> Inverter model corrected for each Note 2.</p> <p><b>Page 7-16:</b> Note references added to the carrier frequency table. Following notes rewritten.</p> <p><b>Page 7-24:</b> <i>Motor 2 Setup: E3 to E5</i> list added.</p> <p><b>Pages 7-26, 7-27:</b> F9 constant numbers added.</p> <p><b>Pages 7-29, 7-31:</b> Setting values 16 and 1C (motor 2 selection and motor 2 selected) added.</p> <p><b>Pages 8-4, 8-7:</b> High carrier frequency information added to OH and OL2 fault displays and OH minor fault display.</p> <p><b>Page 8-17:</b> Inverter overload information added.</p> <p><b>Pages 9-2 to 9-4:</b> Specifications completely updated.</p> <p><b>Page 9-11:</b> “Control Unit” corrected to “Braking Unit.”</p> <p><b>Pages 9-11, 9-13:</b> New models added.</p> <p><b>Pages 9-21, 9-23:</b> Noise Filter models added.</p> <p><b>Page 10-5:</b> New models added.</p> |